

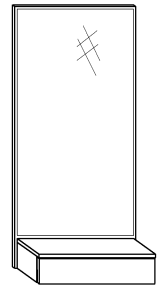

LUSTRO - CITY

→ 48 + 104 \ 23



x 8



(a)

x 4



(b)

x 2



(c)

x 2



(d)

x 2

(182 mm)

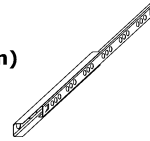

(e)

x 1 kpl.

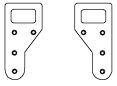

(f)

x 2
(M4-12)



(g)

x 2



(h)

x 4

(3,5x30)



(i)

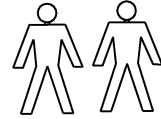

25 min



x 4 (3,5x16)



(j)

x 8 (3x13)



(k)

x 10

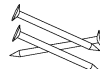

(l)

x 1



(m)

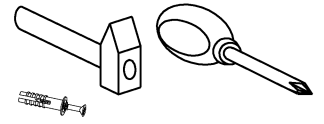

1 - FAZY MONTAŻU

A - OZNACZENIE ELEMENTÓW

a - OZNACZENIE AKCESORIÓW

1

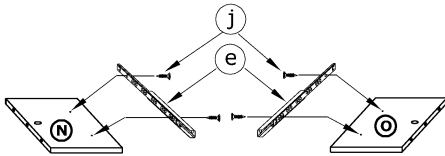

2

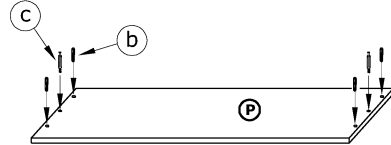

3

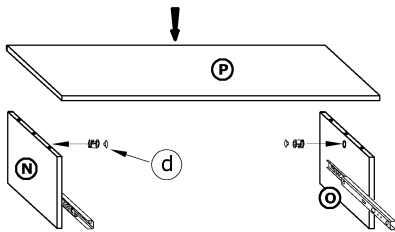

5

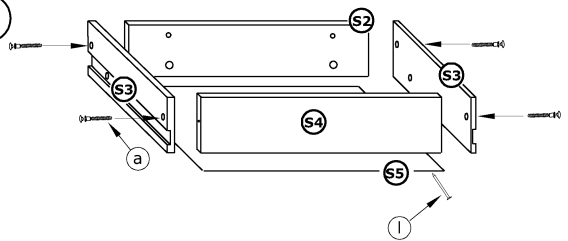

4

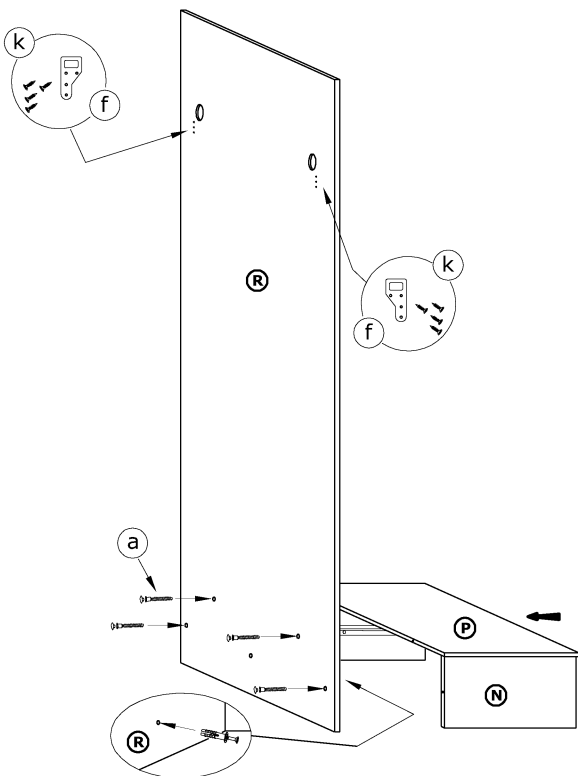

6

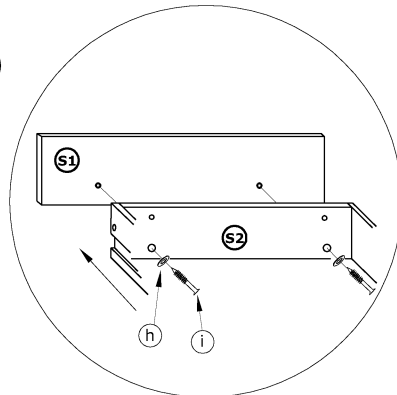

7

