

x 8

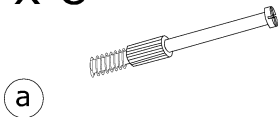

x 8

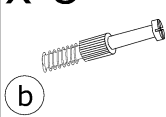

x 16

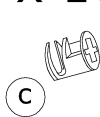

x 8

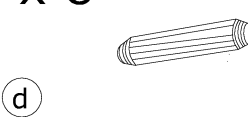

x 4 (505 mm)

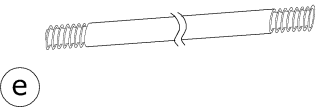

x 4 (200 mm)

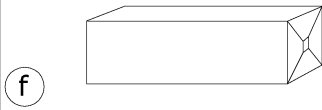

x 4 (283 mm)

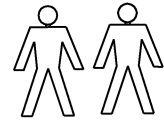
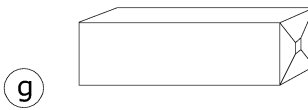

25 min

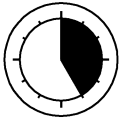

x 4



x 4



x 1

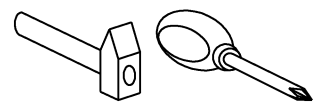
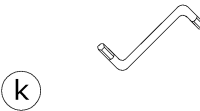

① - FAZY MONTAŻU

Ⓐ - OZNACZENIE ELEMENTÓW

Ⓐ - OZNACZENIE AKCESORIÓW

1

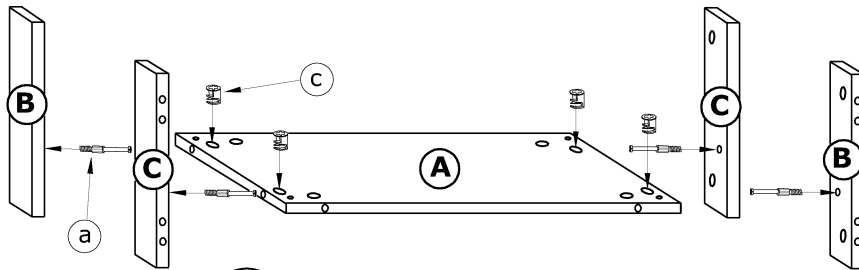

2

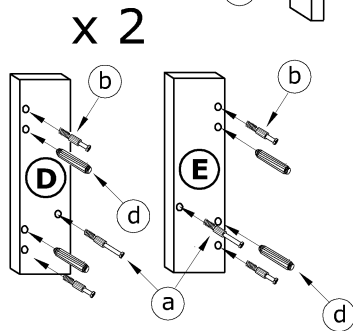

3

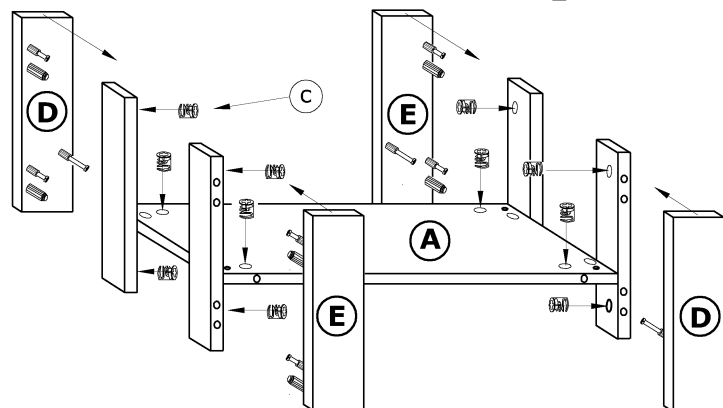

4

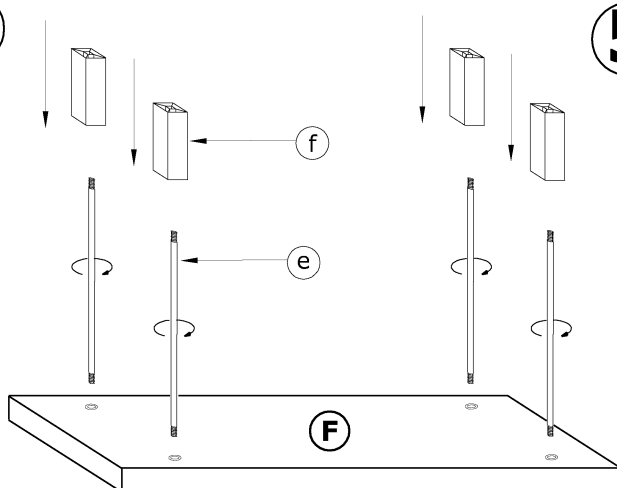

5

