

x 4



(a)

x 2



(b)

x 2



(c)

x 2



(d)

x 4



(e)

x 4



(f)

x 2

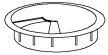

(g)

x 2 (558 mm)

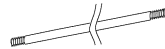

(h)

x 2 (389 mm)



(i)

x 2 (109 mm)



(j)

x 5



(k)

x 5



(l)

x 1

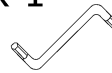

(m)

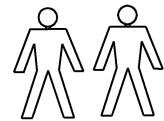

30 min

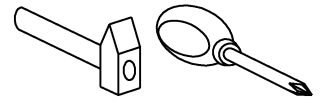
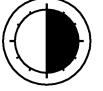

① - FAZY MONTAŻU

Ⓐ - OZNACZENIE ELEMENTÓW

Ⓐ - OZNACZENIE AKCESORIÓW

①

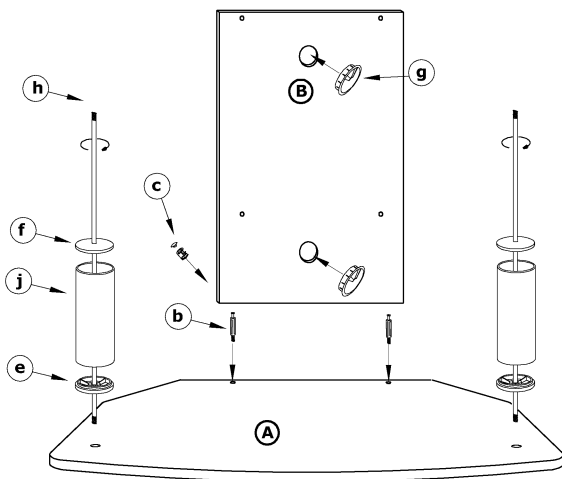

②

