

STUTT GART Glasbodenpaneel 100



HU

Összeszerelési útmutatót

SK

Návod na montáž

D

Montageanleitung

NL

Handleiding voor de montage

TR

Montaj talimatı

GB

Assembly instructions

PL

Instrukcja montażu

RU

Инструкция по сборке

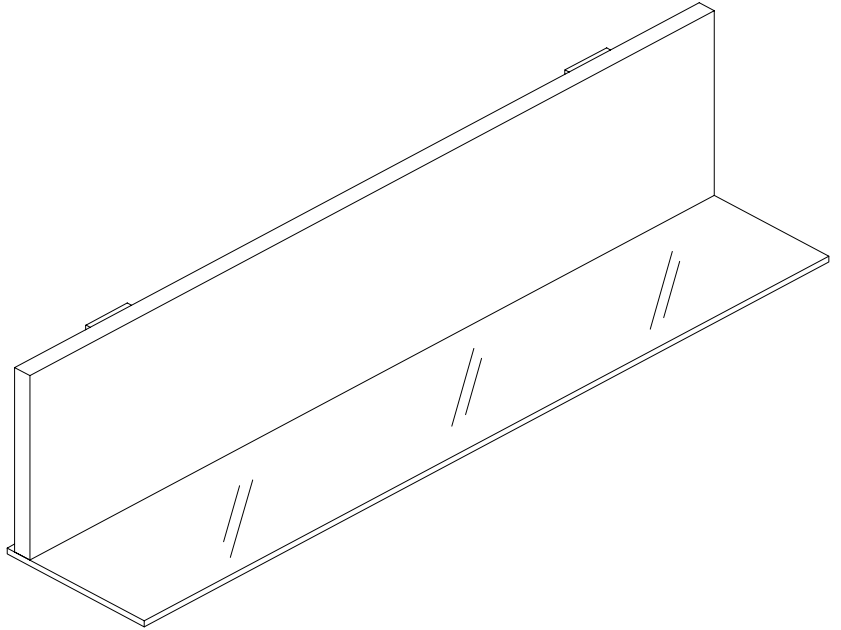

D/A: Achtung: Die Befestigung des Möbelstückes an der Wand muss von einer fachkundigen Person vorgenommen werden, da für die Montage an die Wand angepasste Dübel erforderlich sind.

NL: Opgelet: Een vakkundige persoon dient het meubelstuk aan de muur te bevestigen; voor de montage aan de muur zijn immers aangepaste pluggen vereist.

TR: Dikkat: Mobilya parçasının duvara sabitlenmesi, duvar montajı için özel uyarlanmış dübeller gerektirdiğinden bu iş sadece bu konuda uzman bir kişi tarafından gerçekleştirilmelidir.

GB: Attention: A qualified professional is required when mounting furniture to the wall since dowels corresponding to the wall are required for this.

PL: Uwaga: Mocowanie mebla do ściany może przeprowadzić wyłącznie odpowiedni do tego personel, ponieważ w czasie montażu w ścianie konieczne jest zastosowanie dopasowanych kołków.

RUS: Внимание: Поскольку для монтажа на стене необходимо использовать специальные дюбели, мебель должна быть закреплена на стене квалифицированным персоналом.

SK: Upozornenie: Upevnenie nábytok k stene zveríť kvalifikovaných pracovníkov

HU: Megjegyzés: Rögzítése bútorok a falhoz bízza szakképzett személyzet

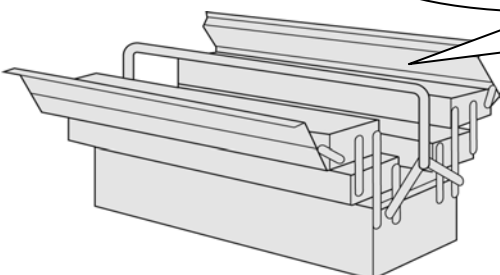
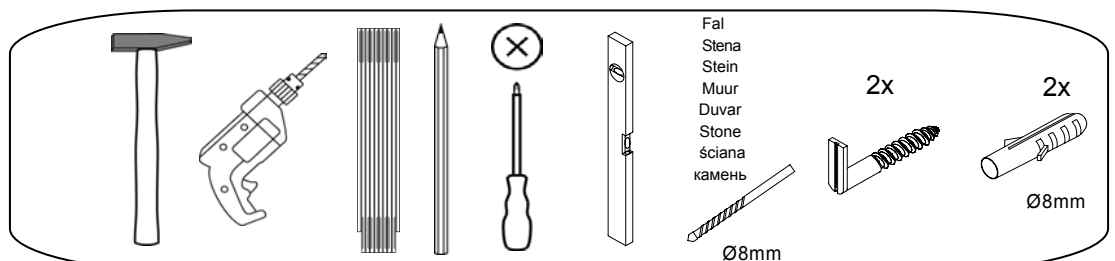
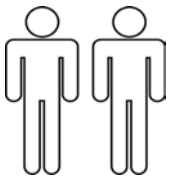

Service•Dienstverlening•Serwis•Servis•Сервисная служба•Szerviz

Name•Naam•Nazwa•Isim•Название•Názov•Név





STUTT GART

Typ•Type•Тип•Тип

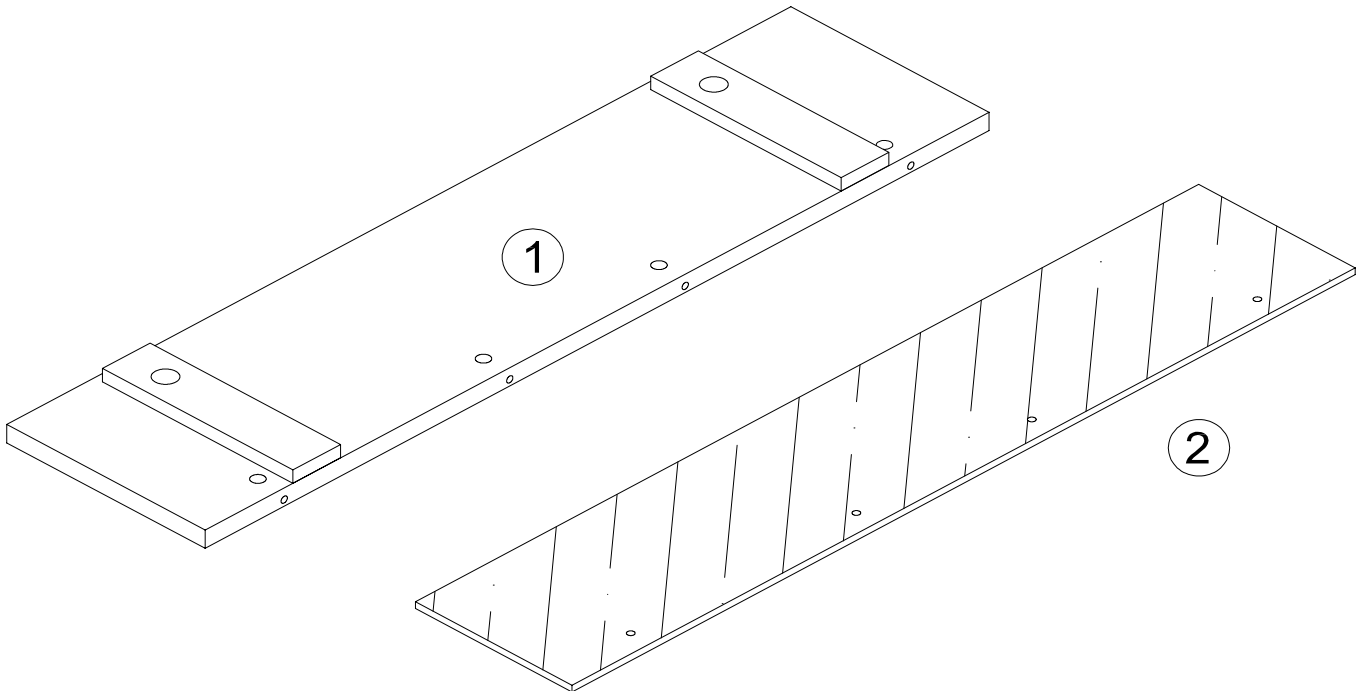
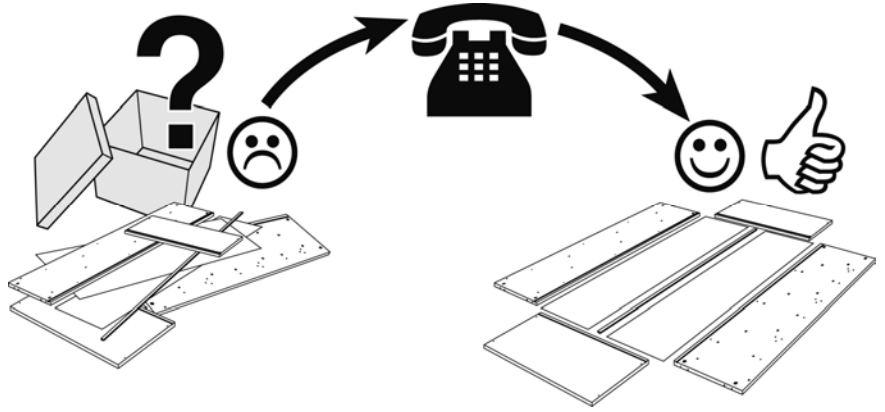
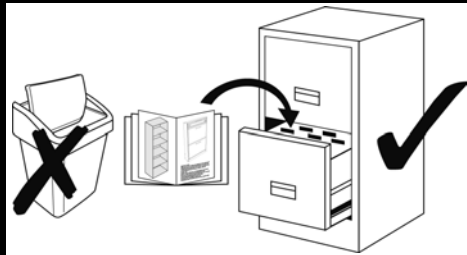
Glasbodenpaneel 100

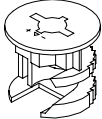
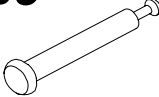
 **Weiß Matt/ Weiß Glanz**
Schwarz Matt / Schwarz Glanz

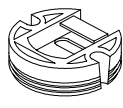

A1 	B9 	P10  3,5 x 13 kl. Kopf	U6 	X20  12 mm
4	4	4	2	4

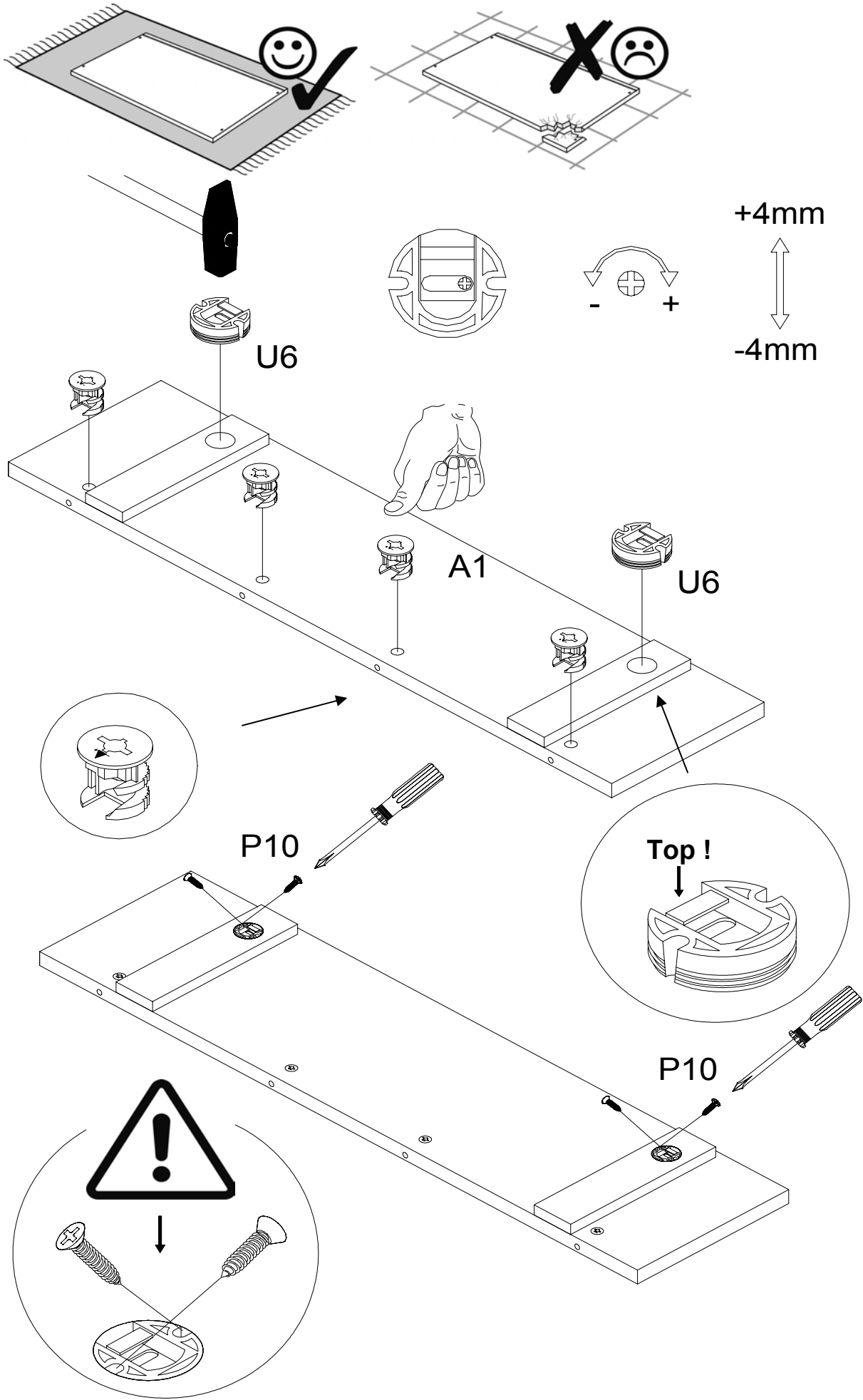

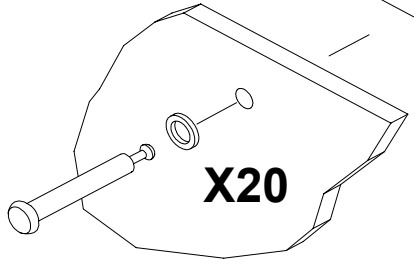
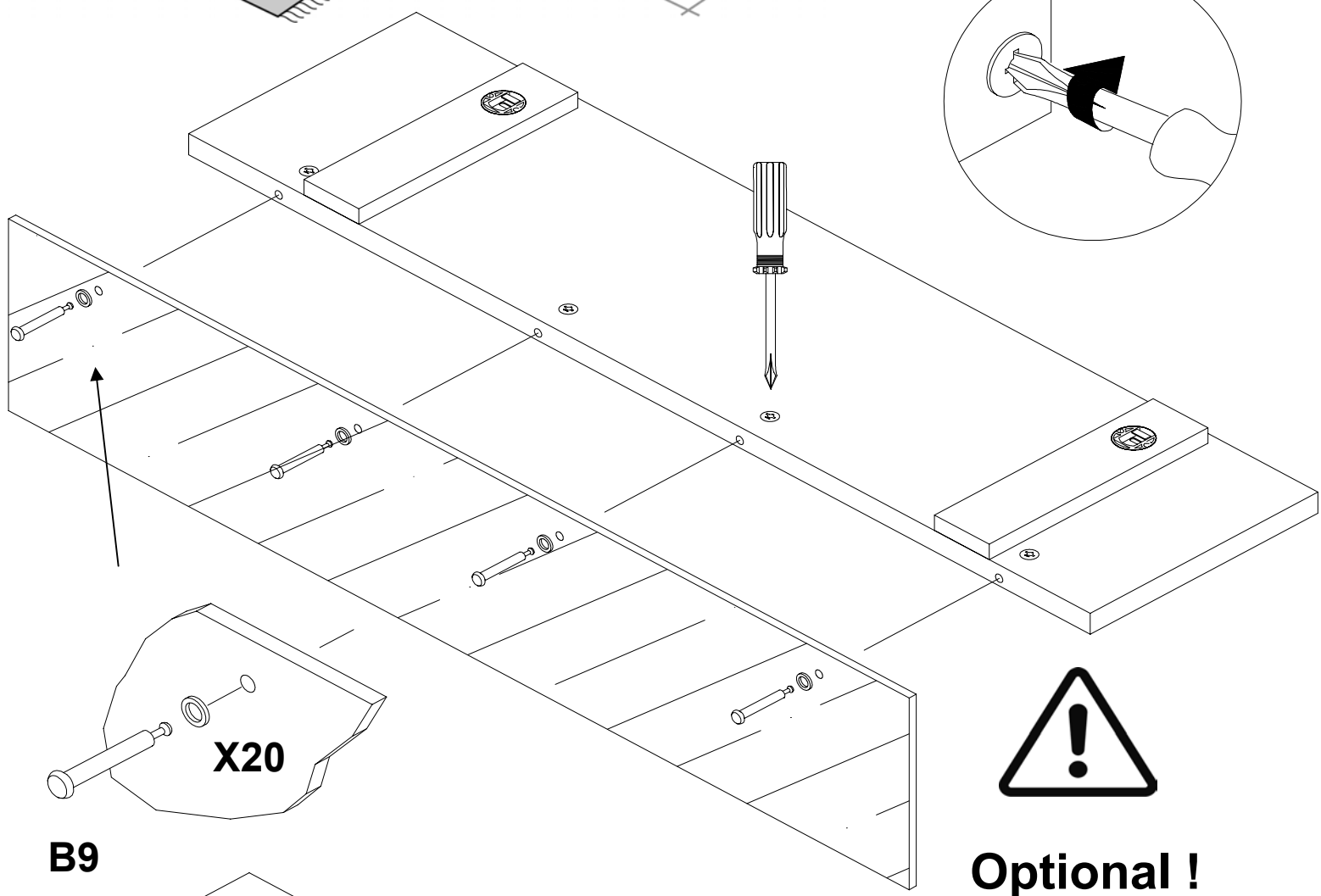
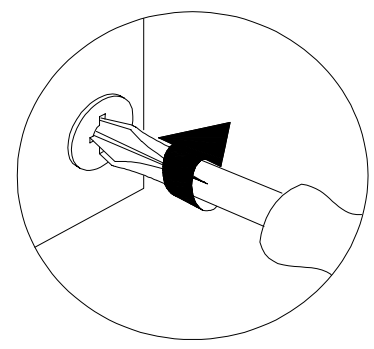
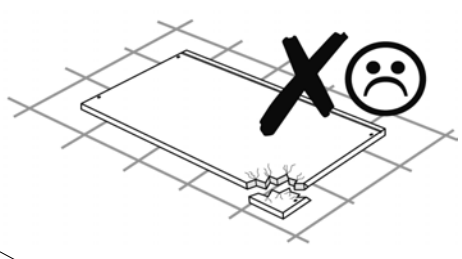
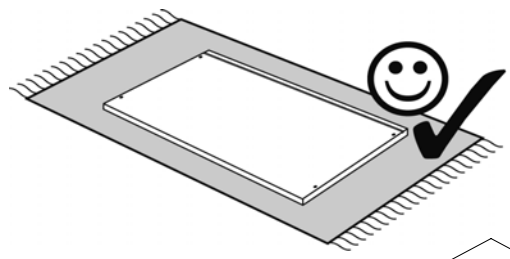

B9



Optional !
LED /RGB

