

DIXI

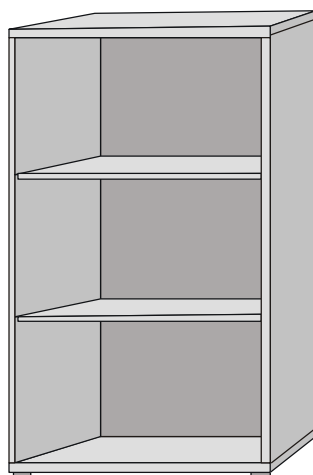

DXR40

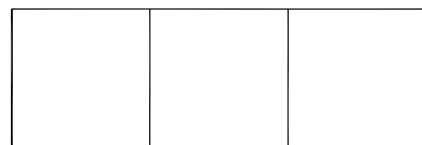
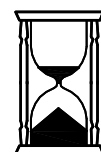
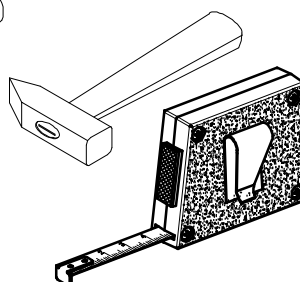
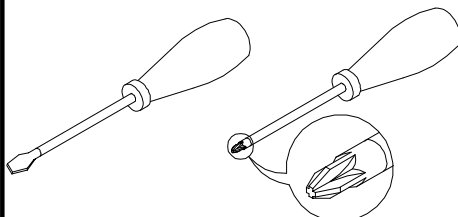

60 MIN

DXR40

A	x2	15411
B		04616
C		35418
D		35417
E	x2	44436

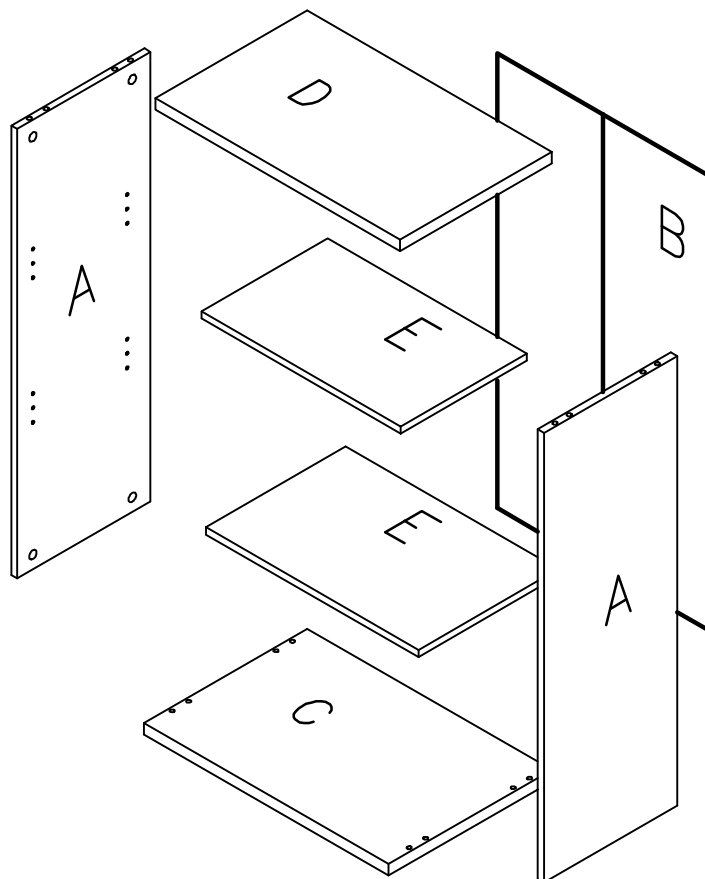

DXR40

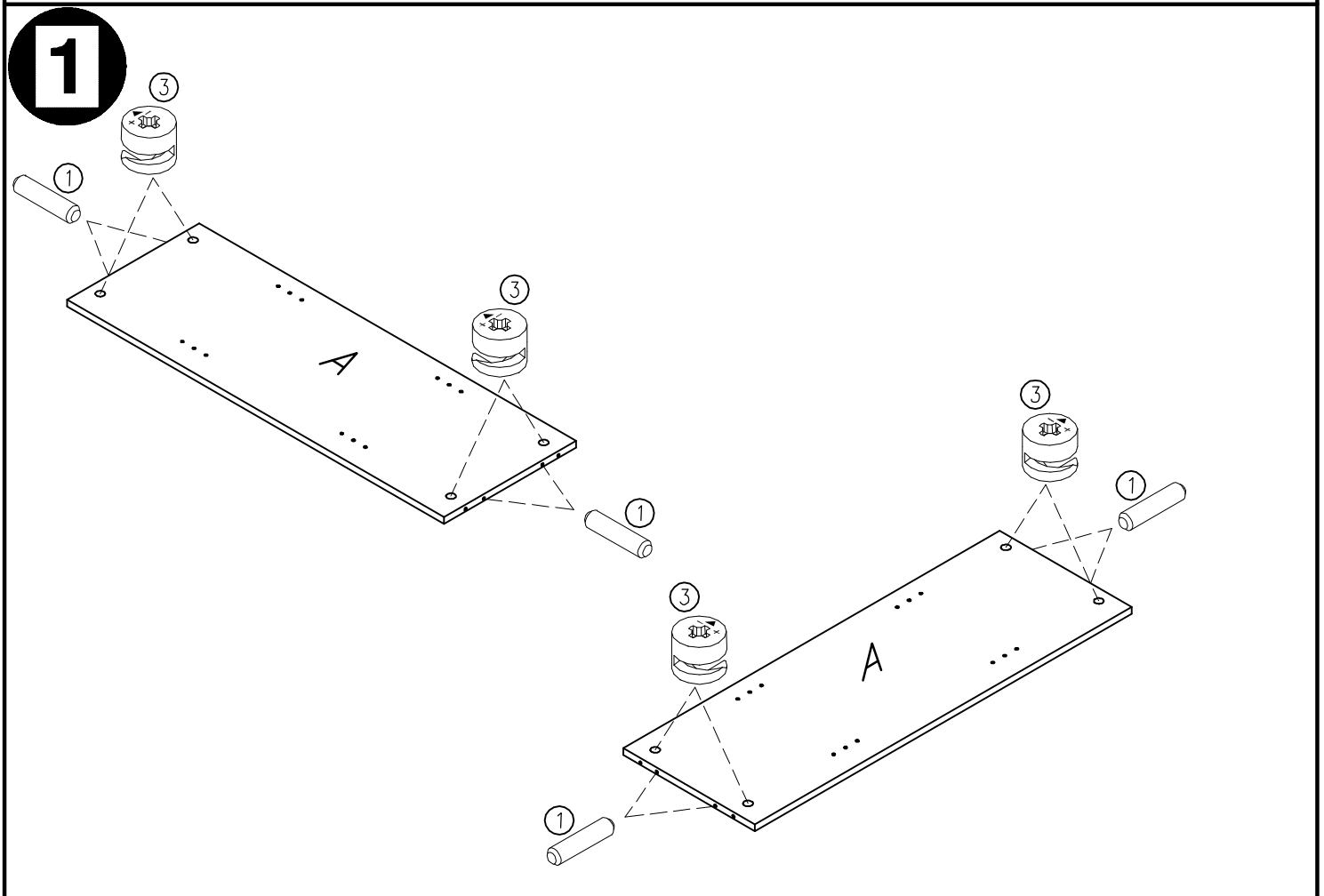
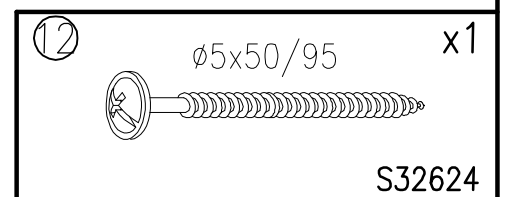
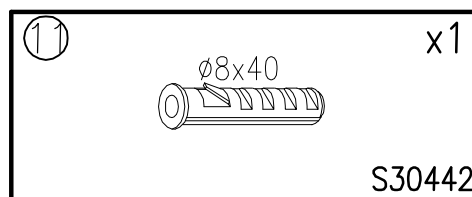
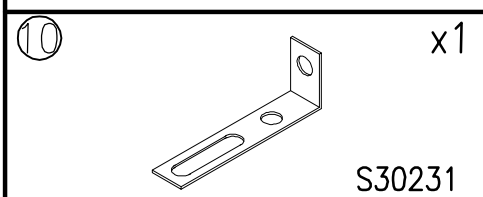
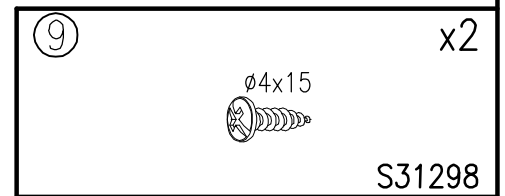
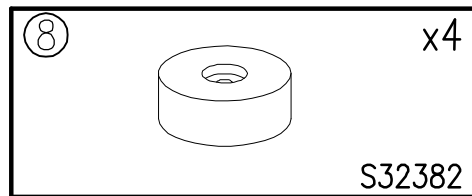
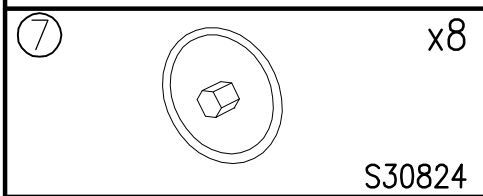
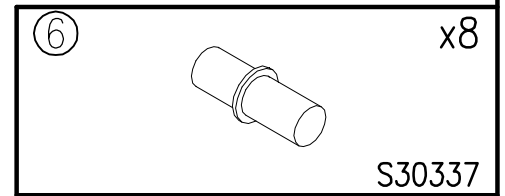
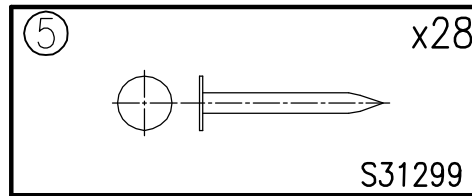
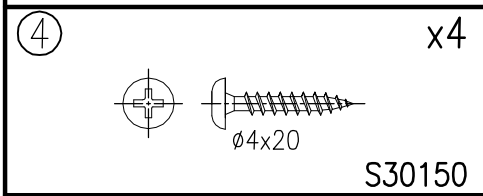
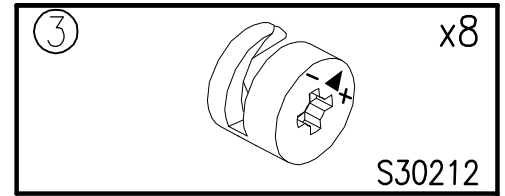
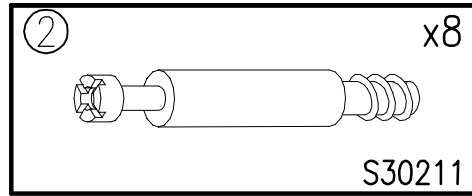
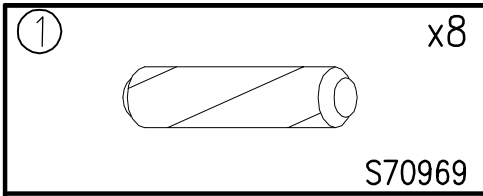

2

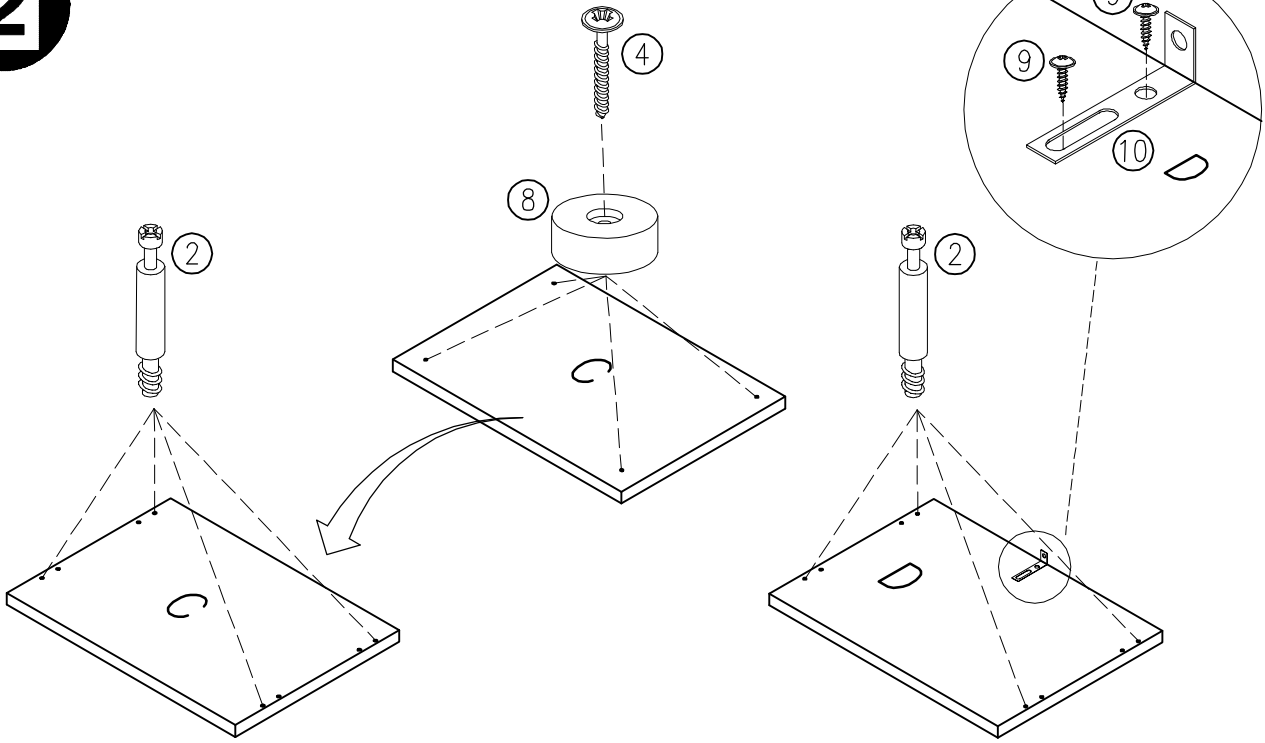

3

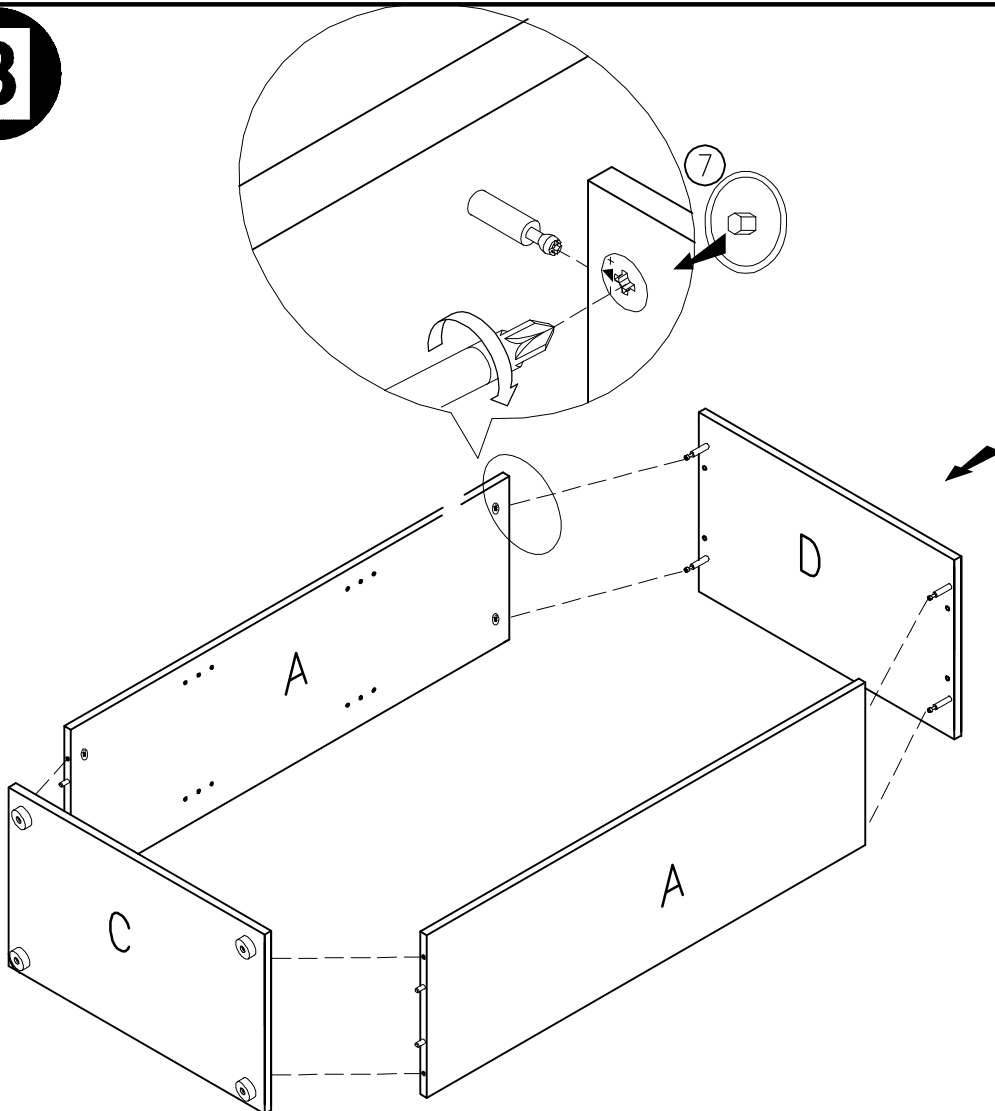

4

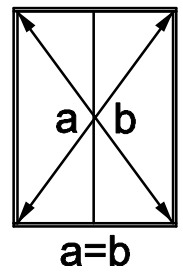
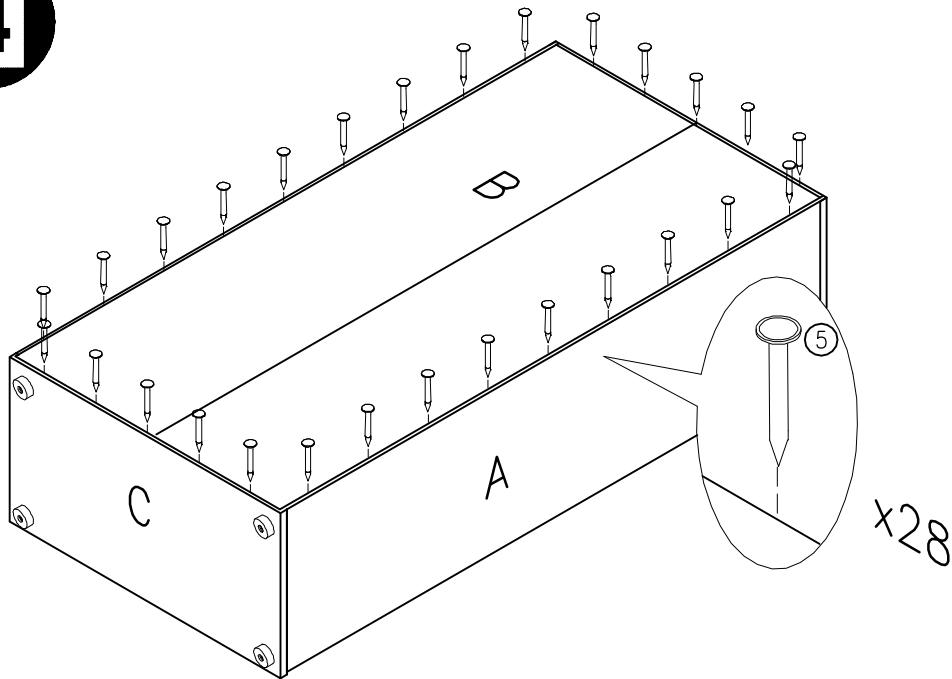

5

