

2 Personen
2 Osoby

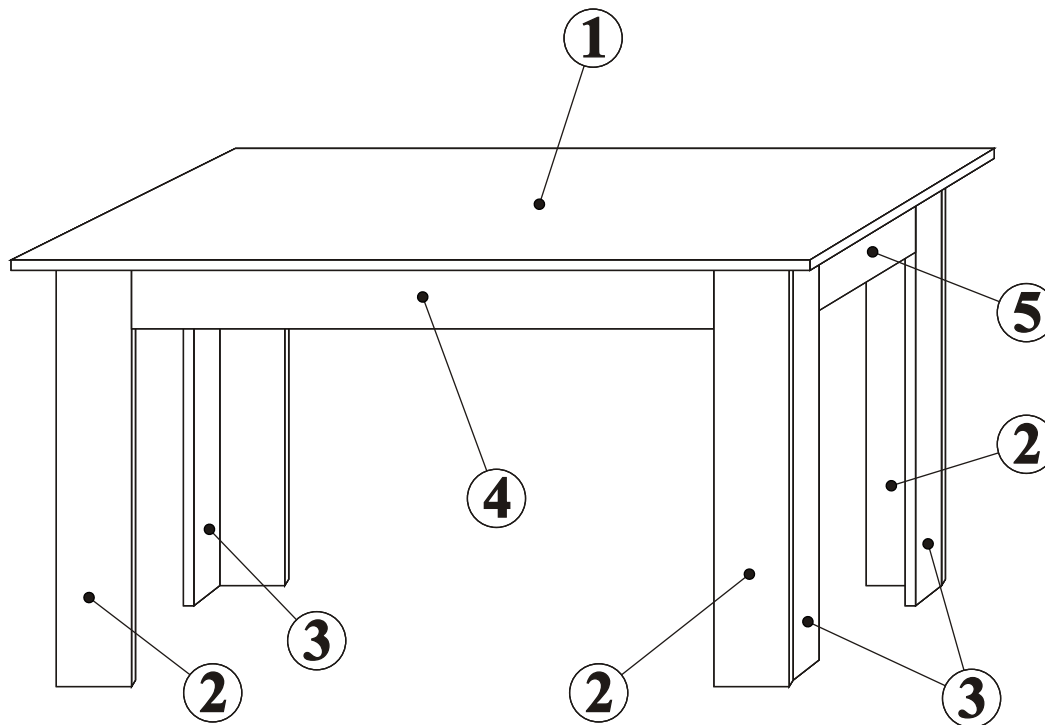

a im lne za a enie

motnos a mm	os			

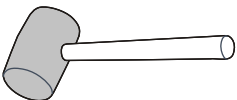
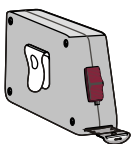
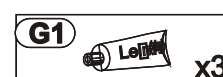
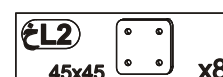
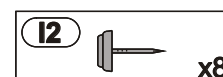
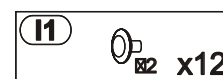
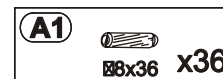
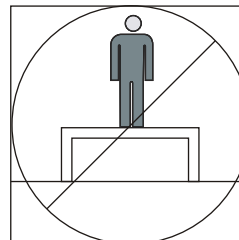
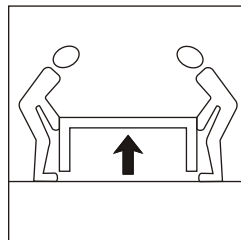
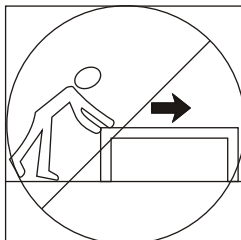

3

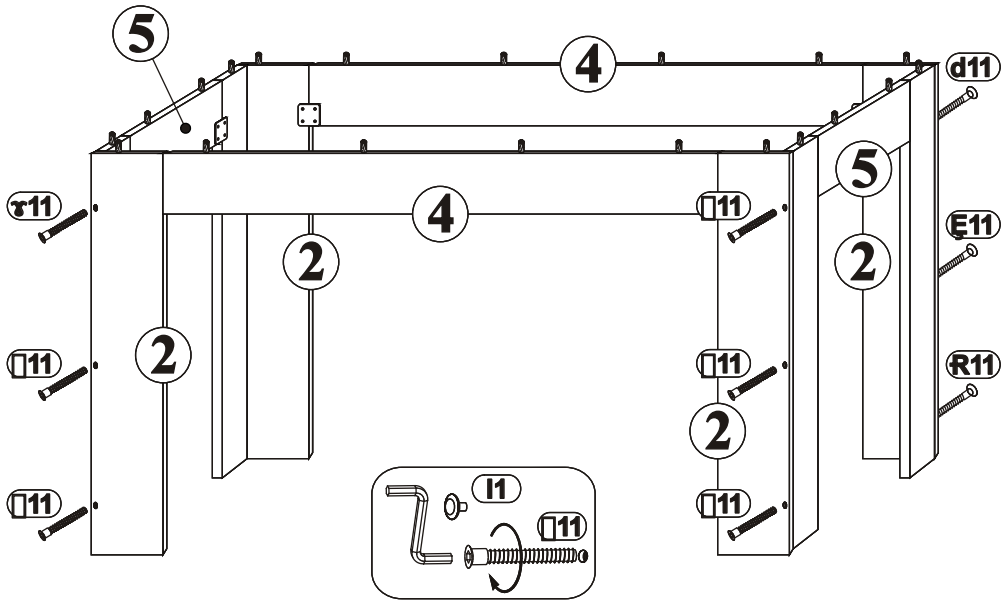
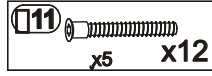

4

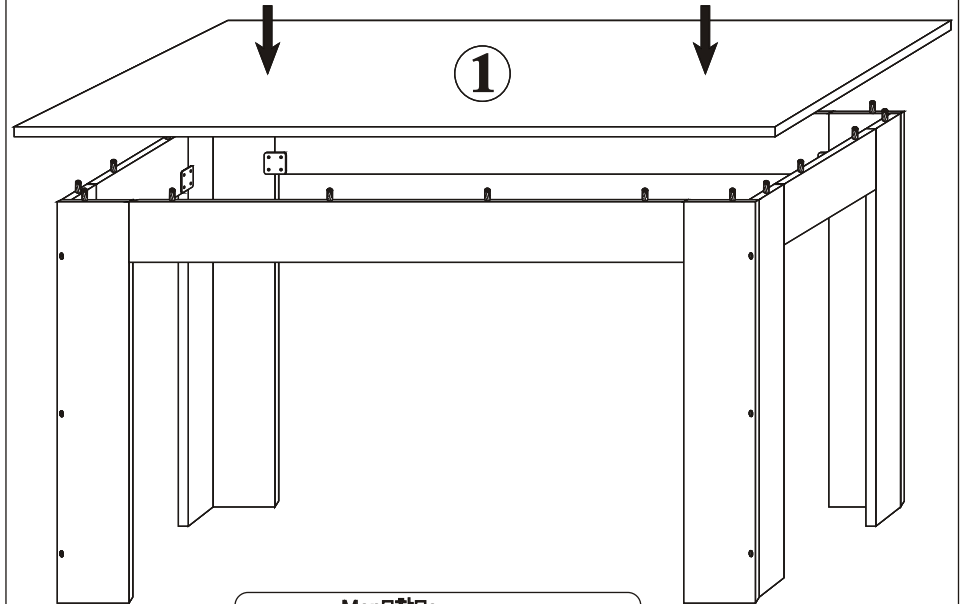
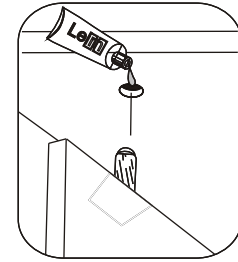

Mon[한]e

