

INSTRUKCJA MONTAŻU
FITTING-UP INSTRUCTION
ІНСТРУКЦІЯ МОНТАЖУ
ИНСТРУКЦИЯ СБОРКИ

MONTÁŽNY NÁVOD
INSTRUCTIONS POUR LE MONTAGE
INSTRUCCIONES DE MONTAJE
SZERELÉSI ÚTMUTATÓ
UPUTE ZA SASTAVLJANJE

Do montażu potrzebne są:
You need for fitting-up:
Для монтажу потрібні:
Для сборки нужны:

Pour le montage il faut:
Para realizar el montaje es necesario:
K montá i potrebuje:
A szereléshez szükséges:
Za sastavljanje su potrebne:

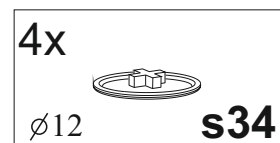
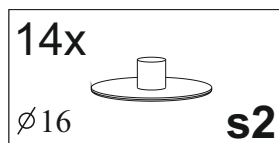
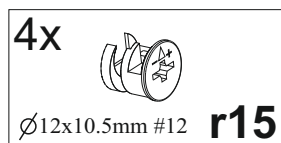
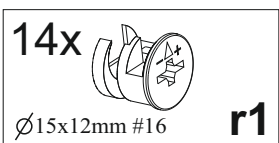
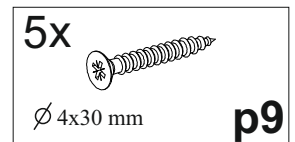
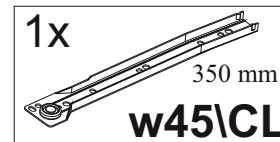
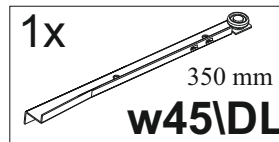
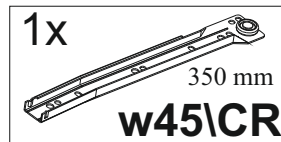
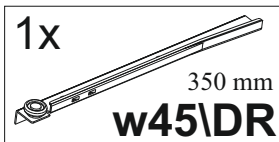
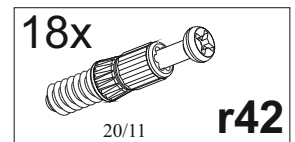
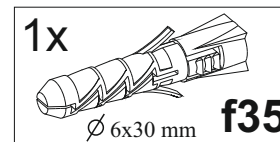
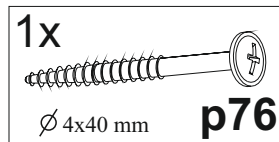
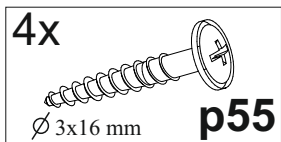
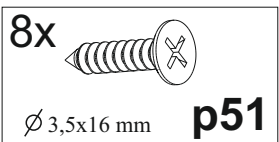
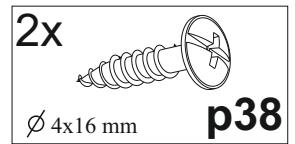
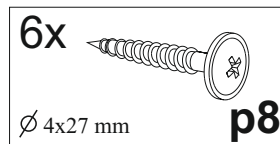
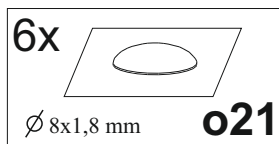
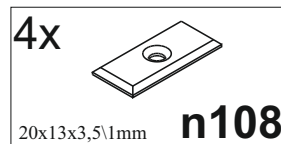
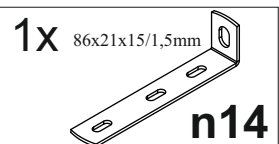
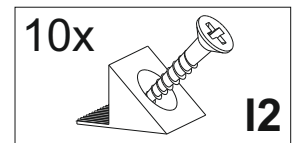
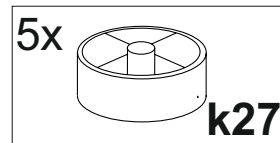
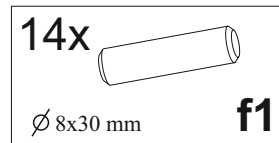
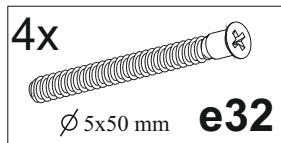
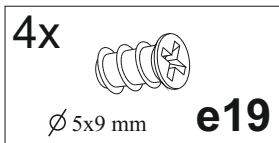
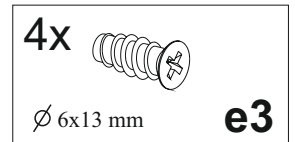
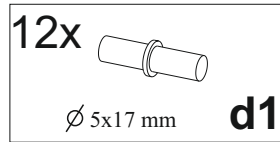
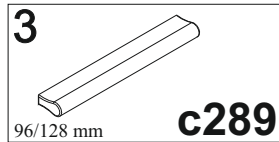
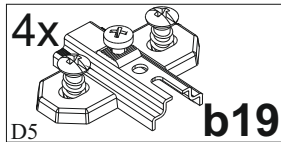
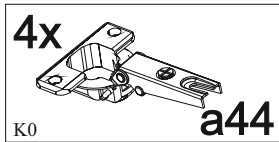
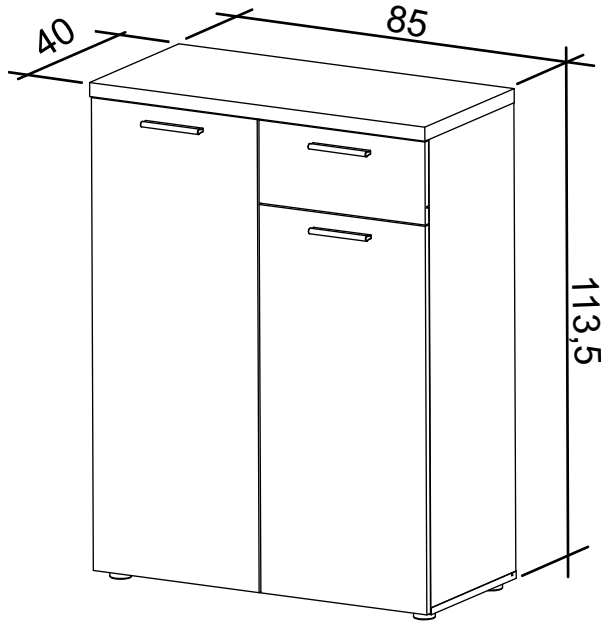
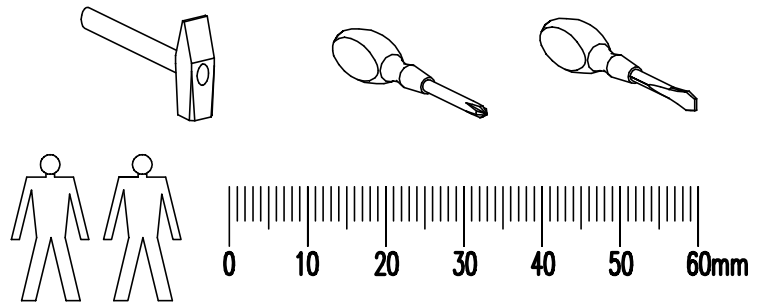
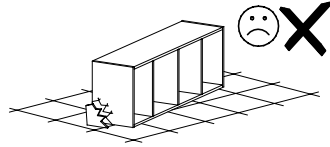
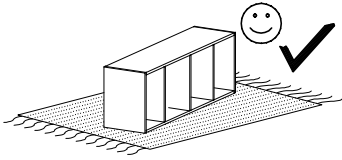

max.



5KG 109

max.



10KG 107

max.



3KG 114

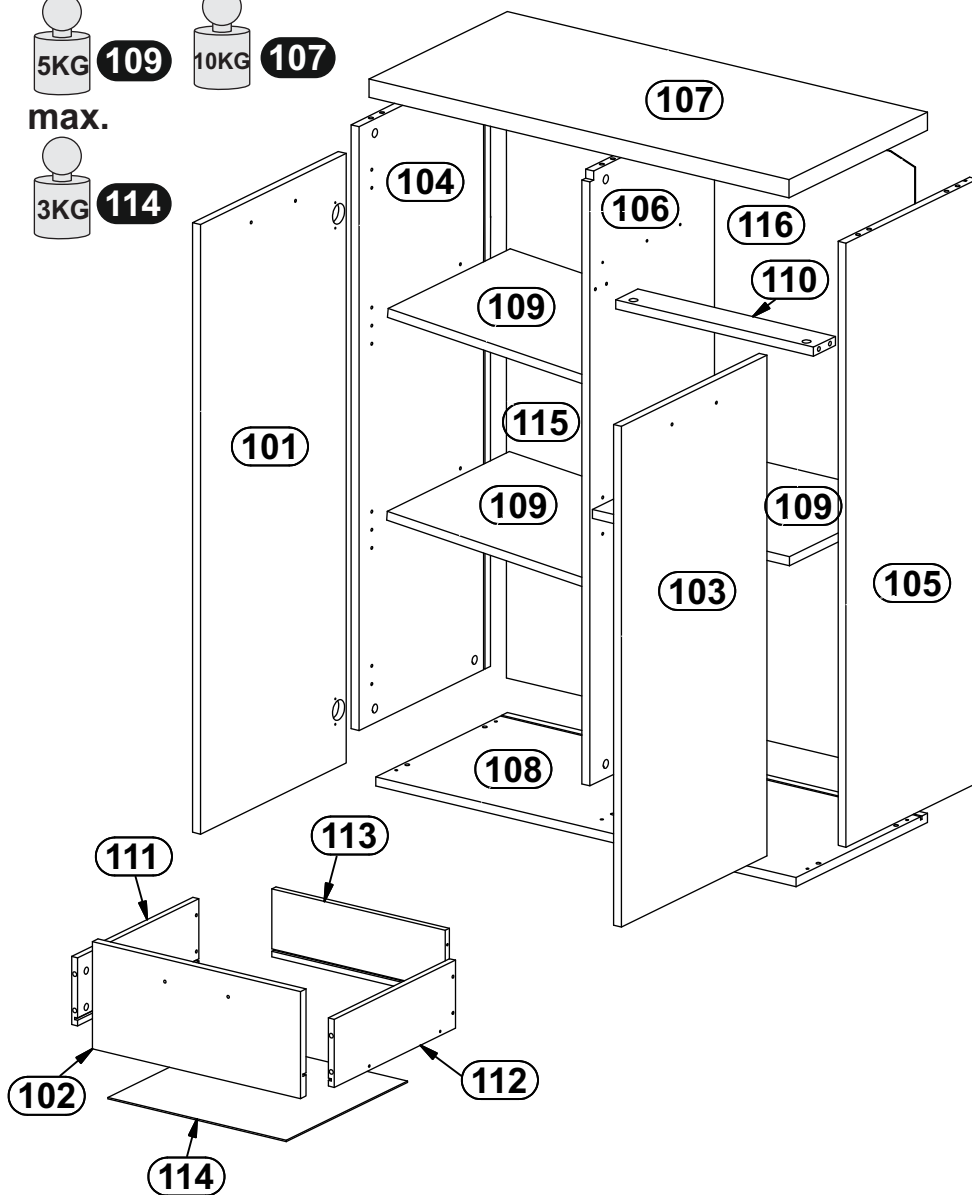

1

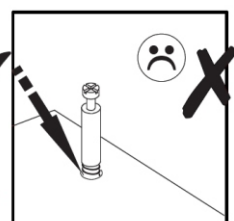
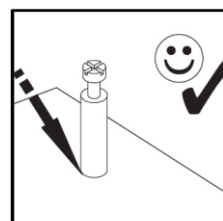
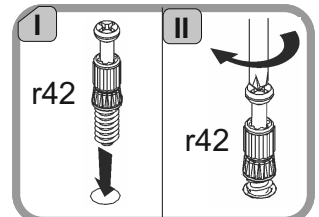
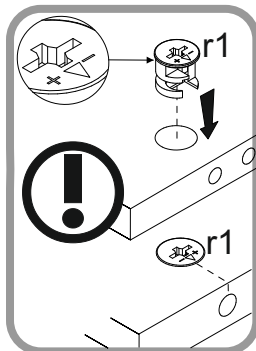
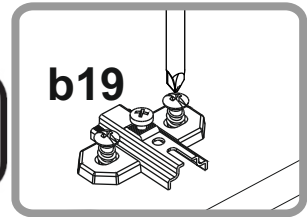
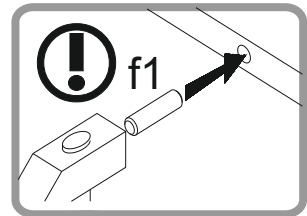
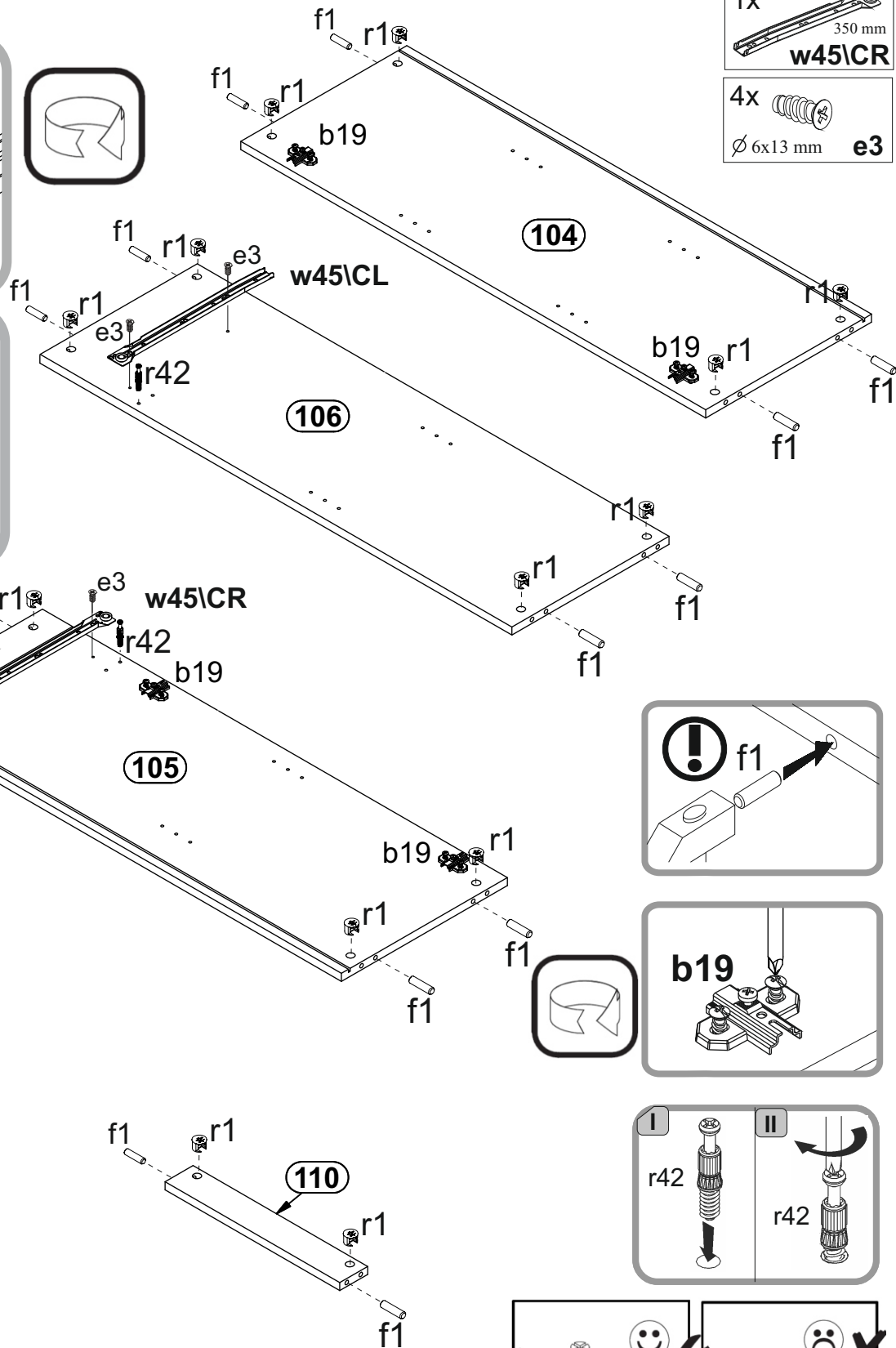
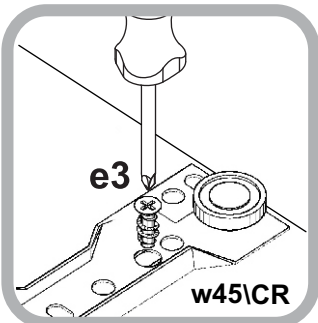
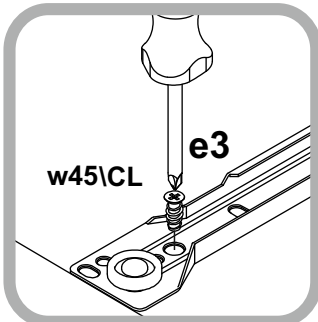
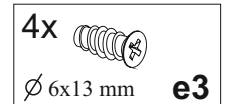
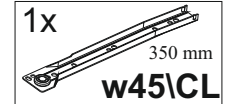
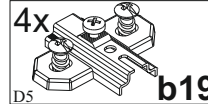
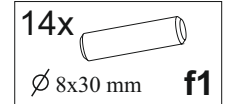
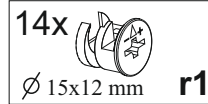
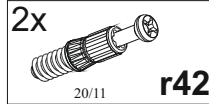
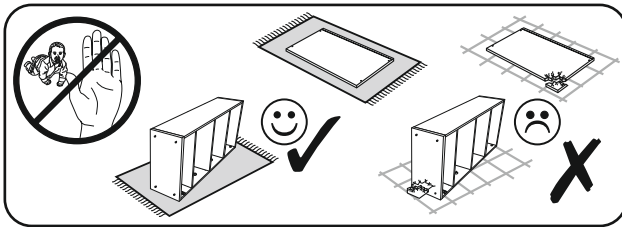

2

12x
20/11
r42

5x
k27

5x
 ϕ 4x30 mm
p9

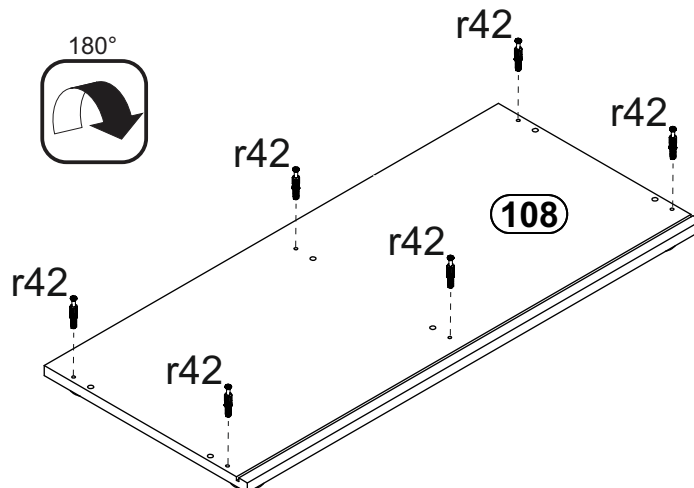
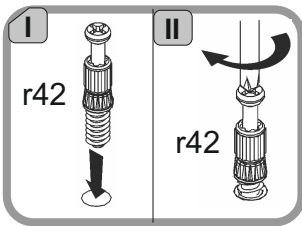
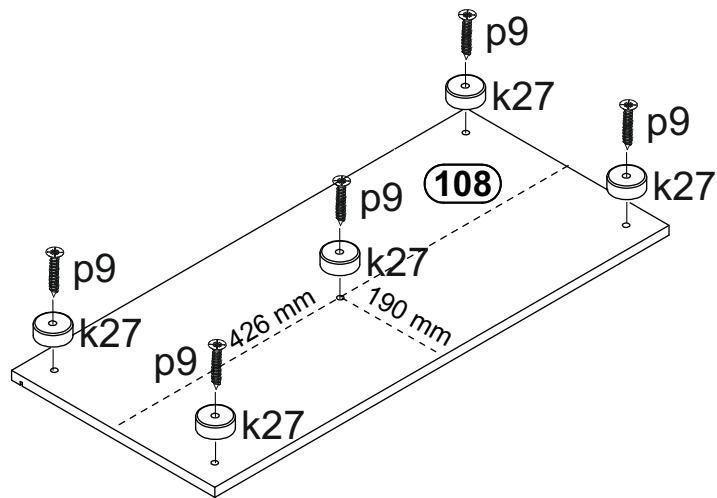
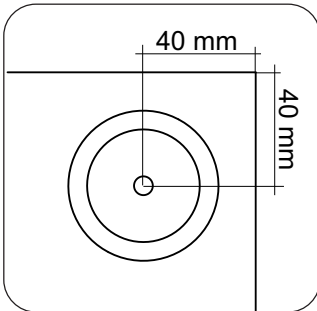
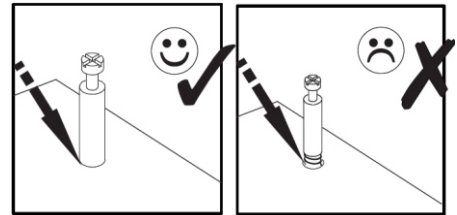
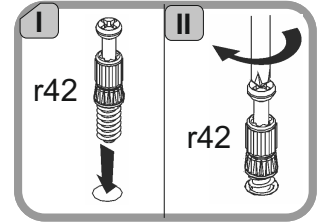
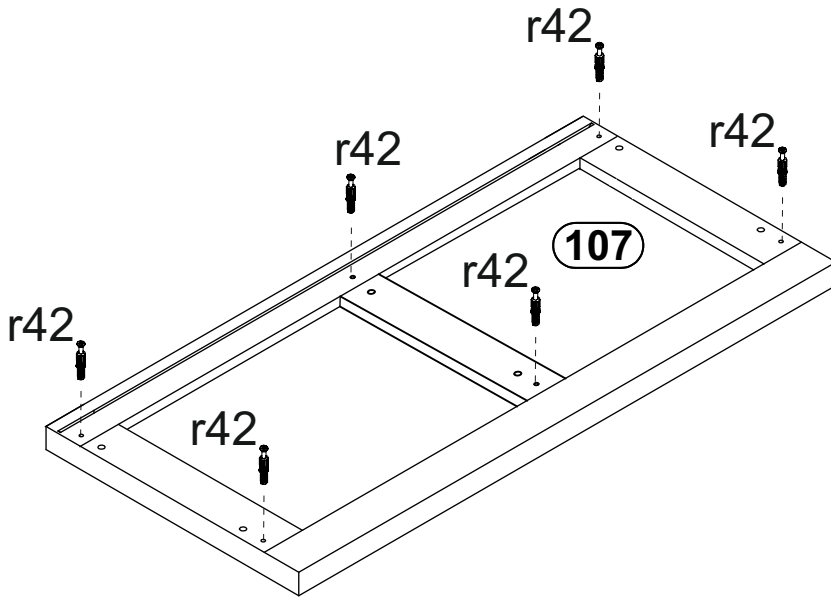

3

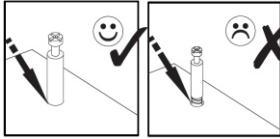
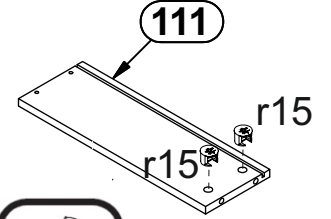
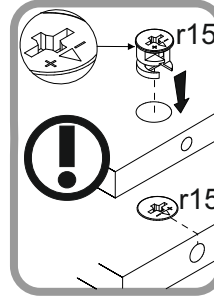
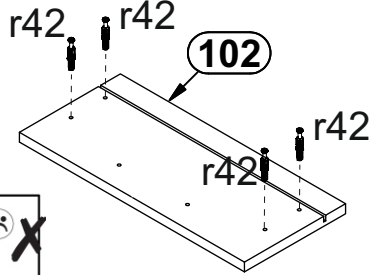
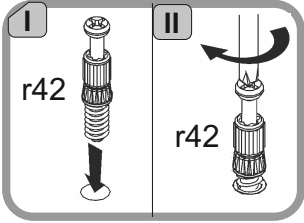
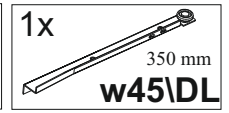
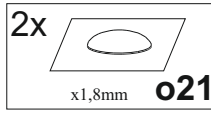
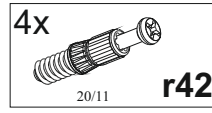
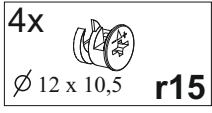
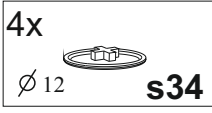
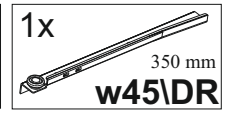
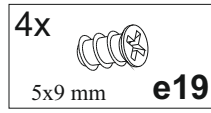
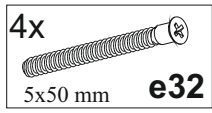
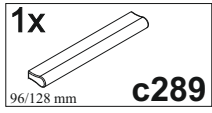
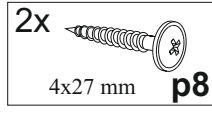

A

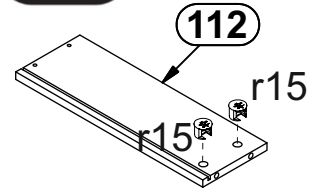
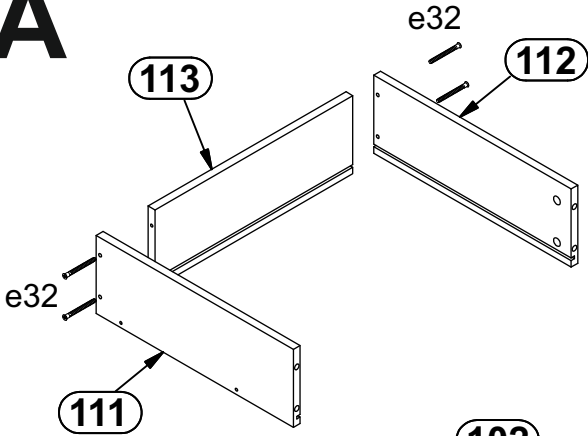

B

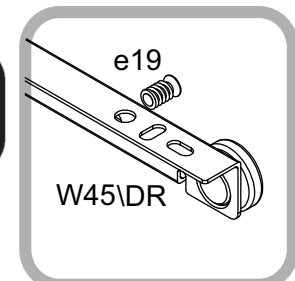
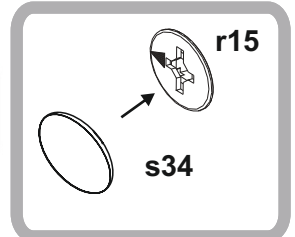
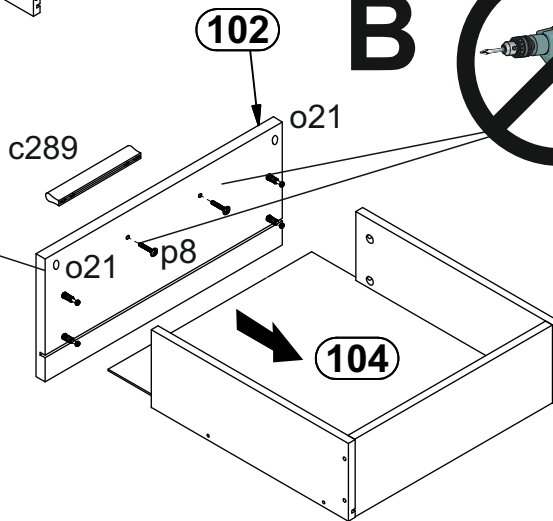
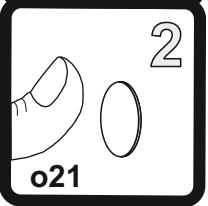
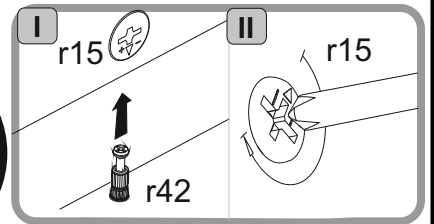
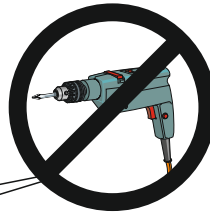

C

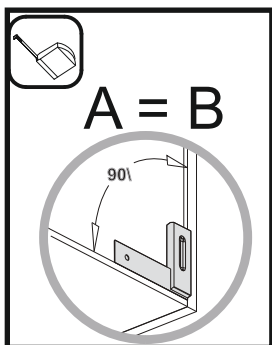
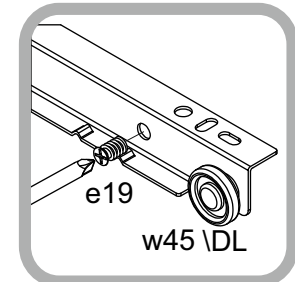
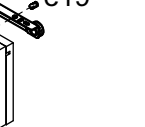
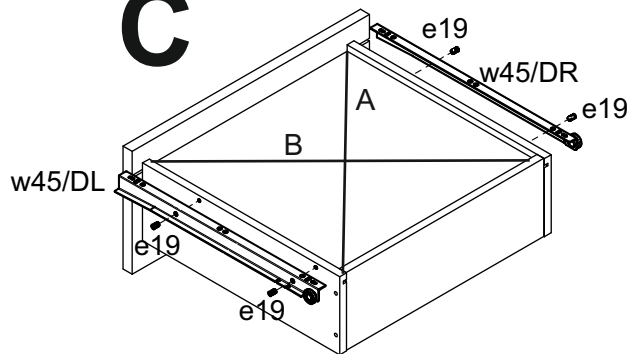

4

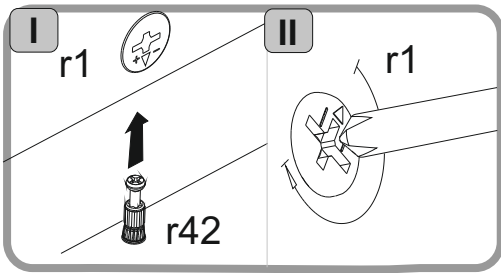
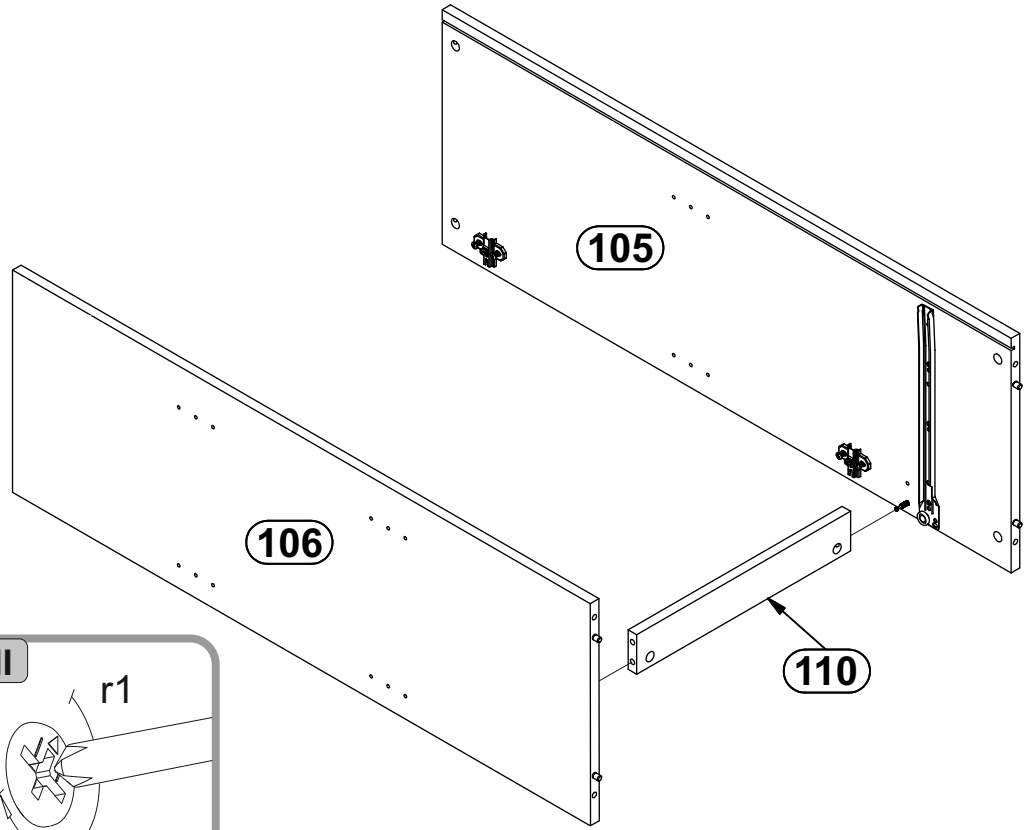

5

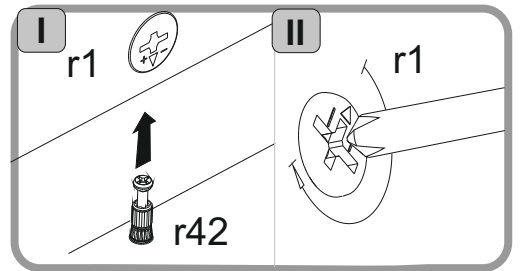
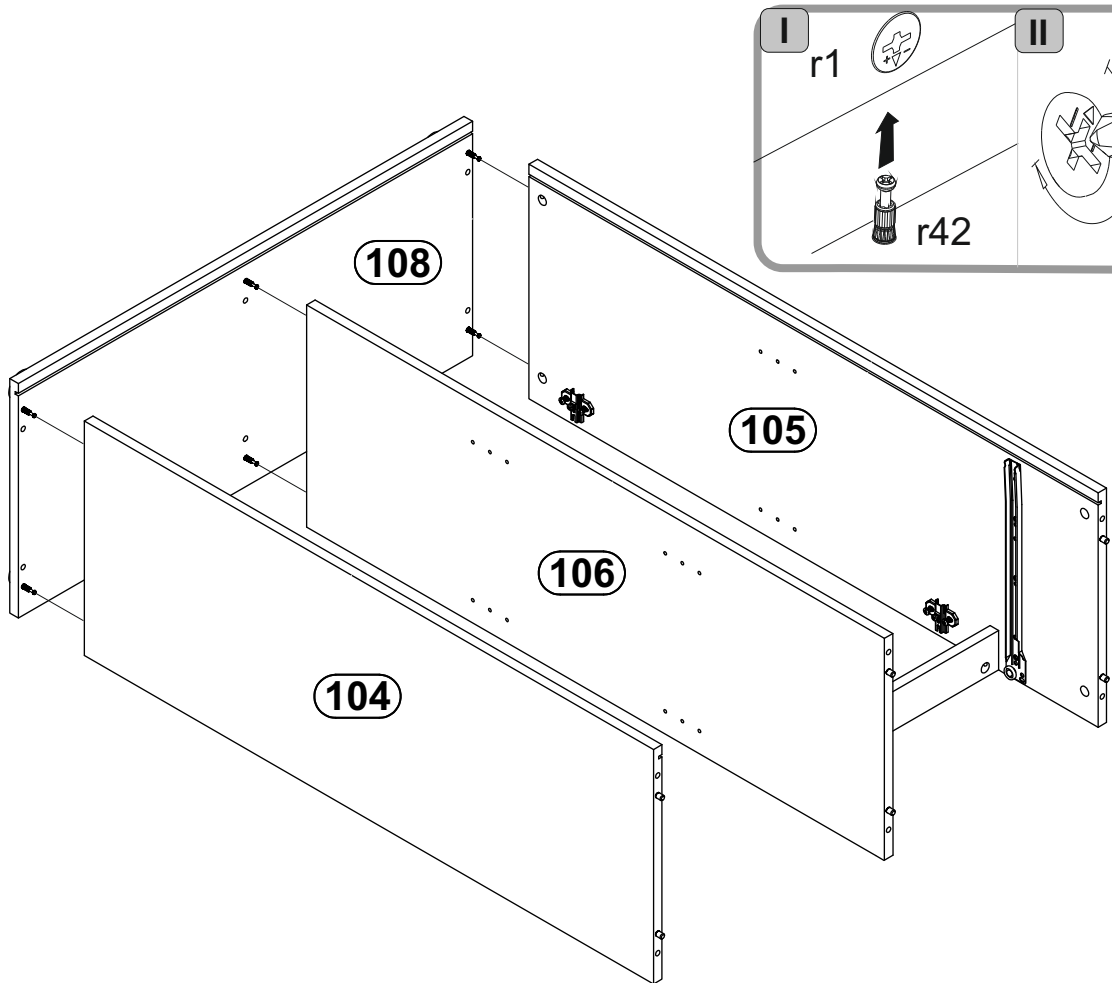

6

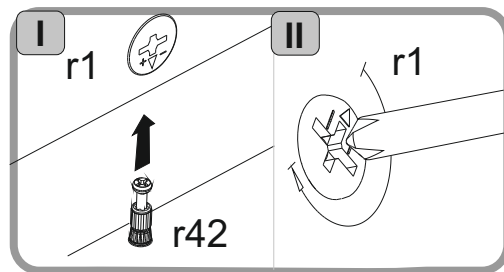
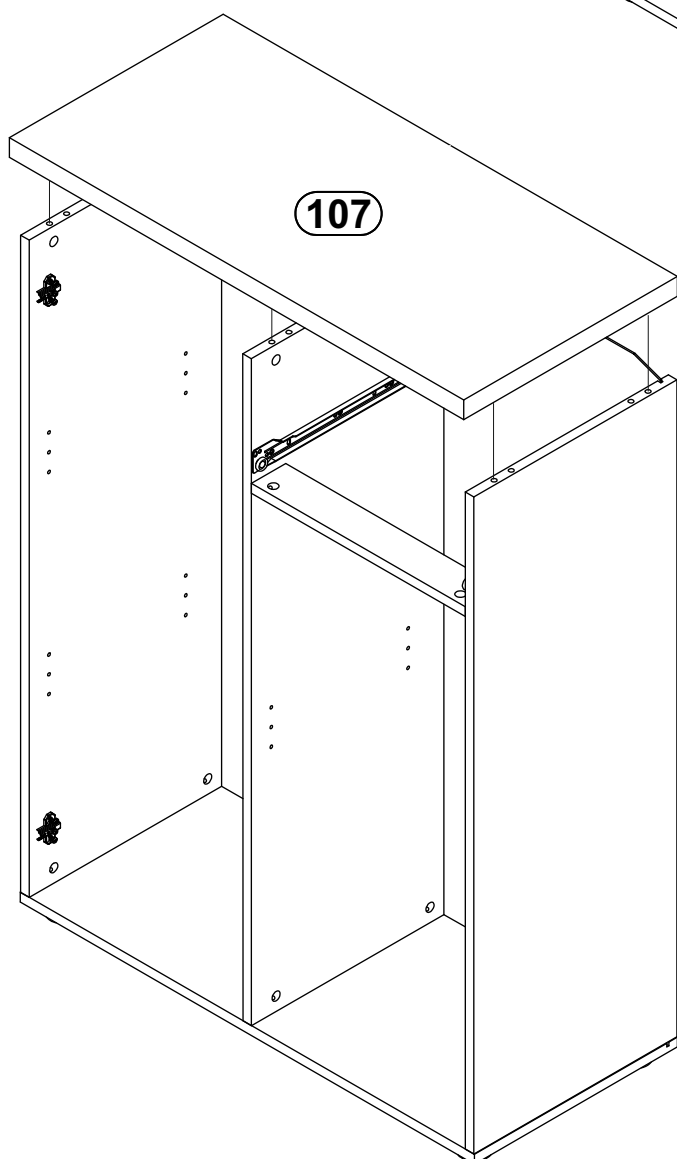
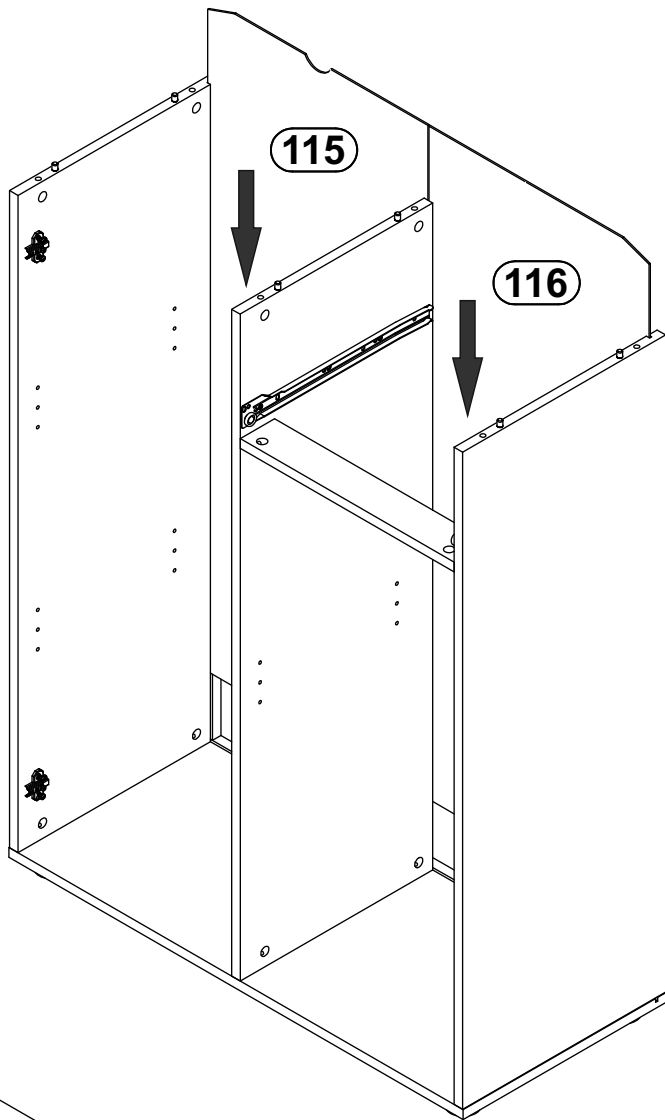

7

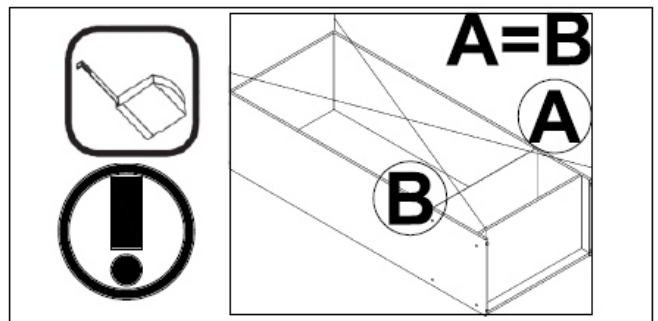
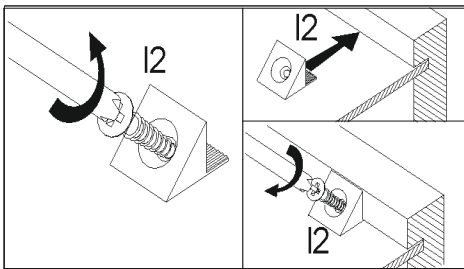
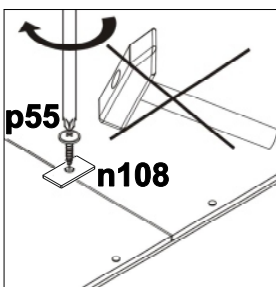
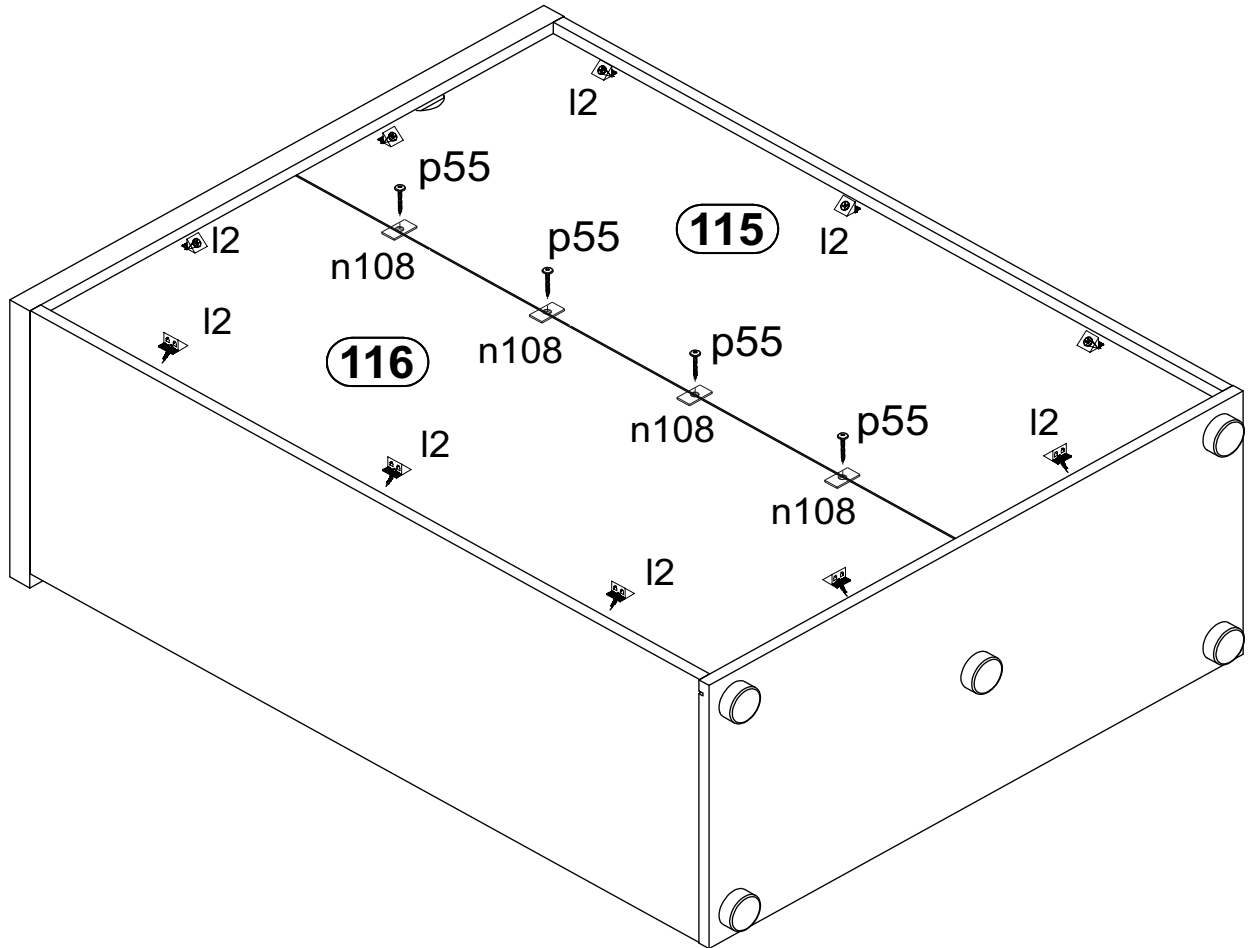
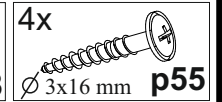
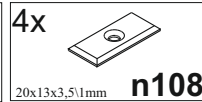
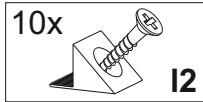

8

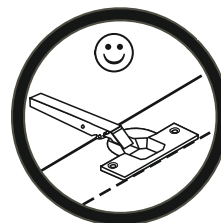
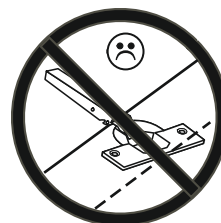
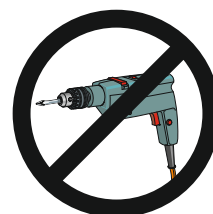
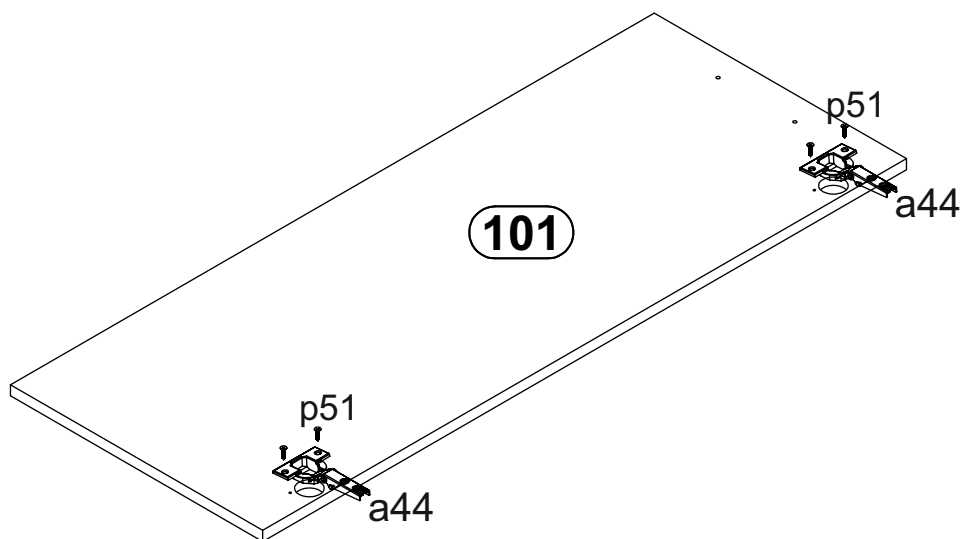
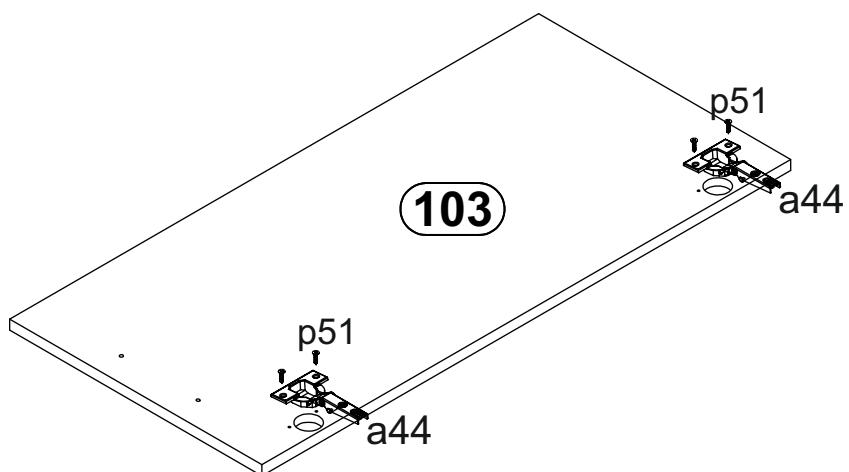
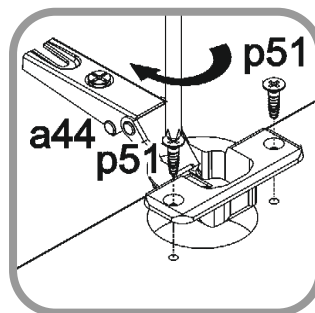
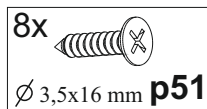
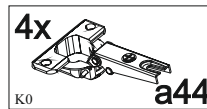
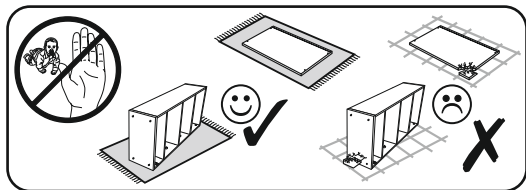

9

14x
∅ 16
s2

12x
∅ 5x17 mm
d1

2x
96/128 mm
c289

4x
∅ 4x27 mm
p8

4x
∅ 8x1,8 mm
o21

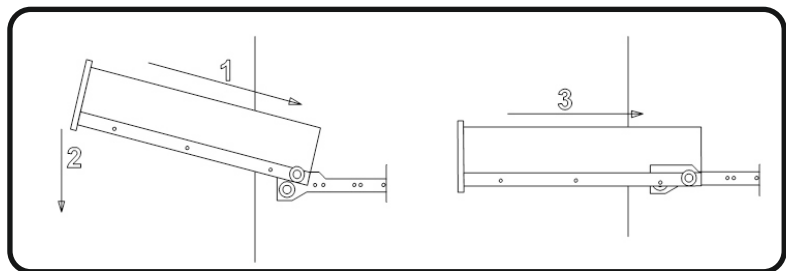
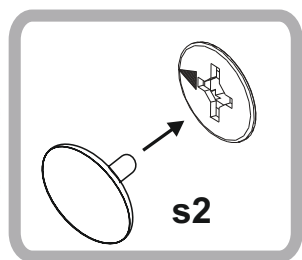
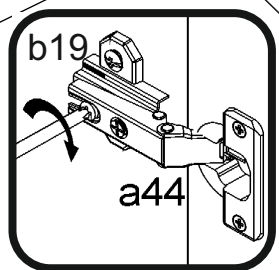
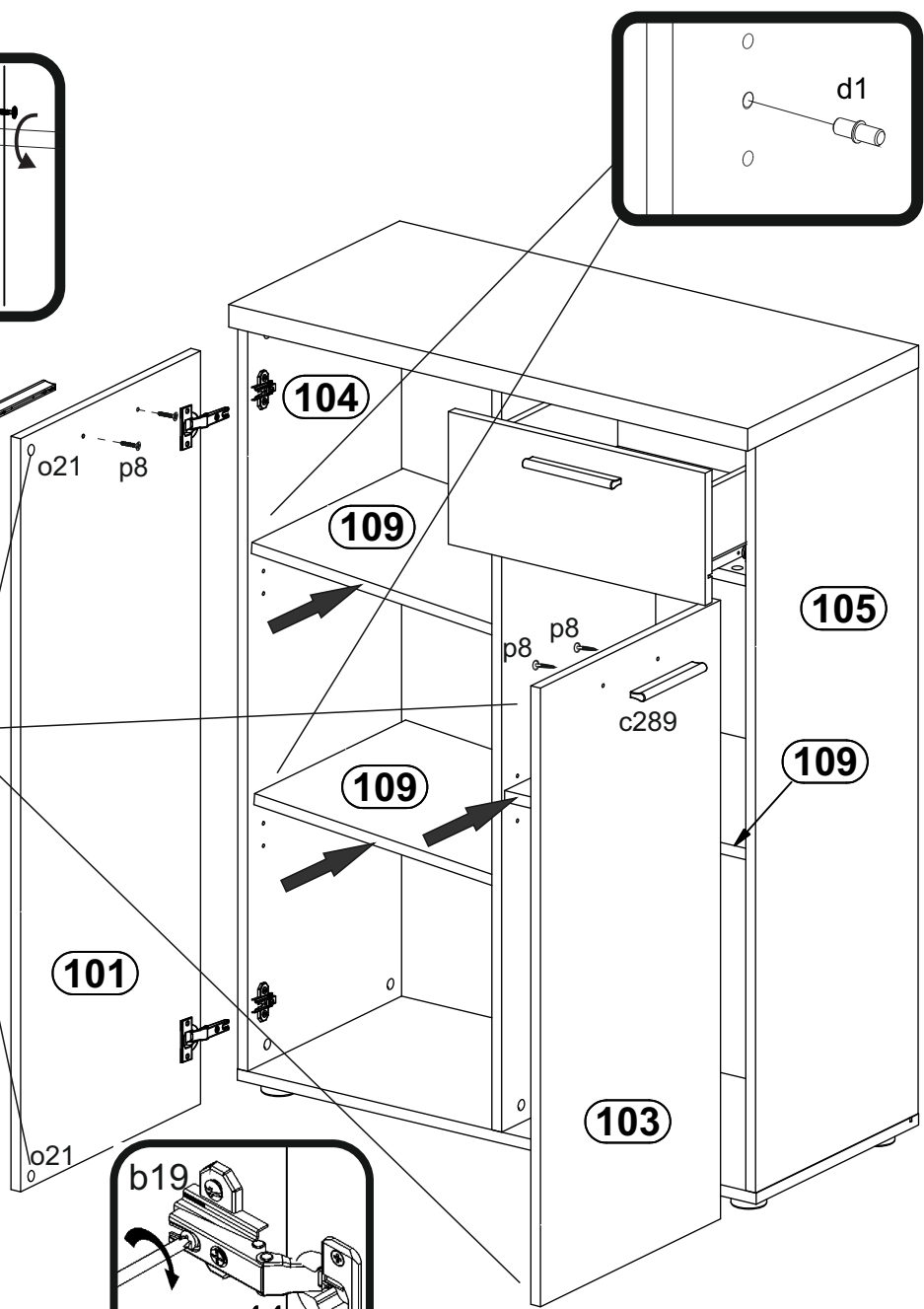
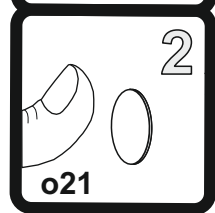
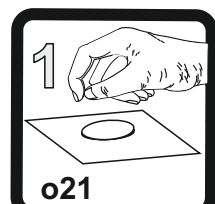
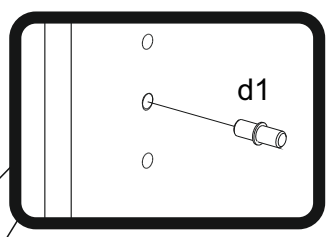
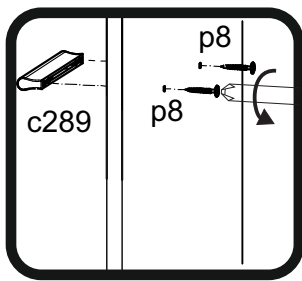

10

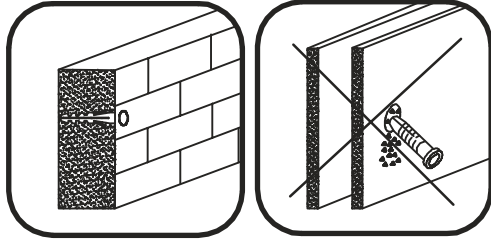
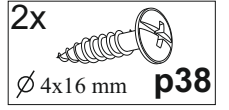
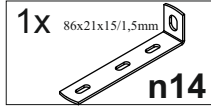
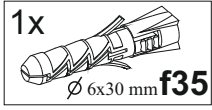
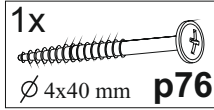

A

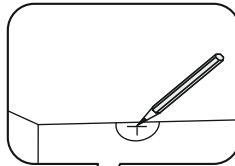

B

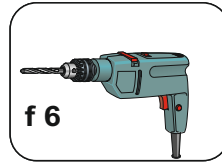

C

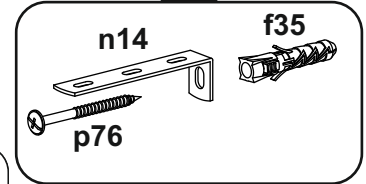

D

