

BABYLON_B5

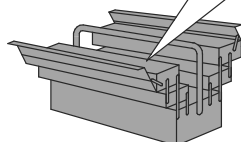

1

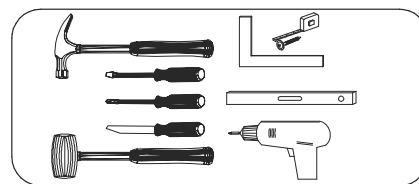
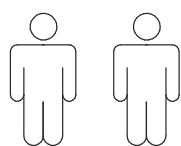
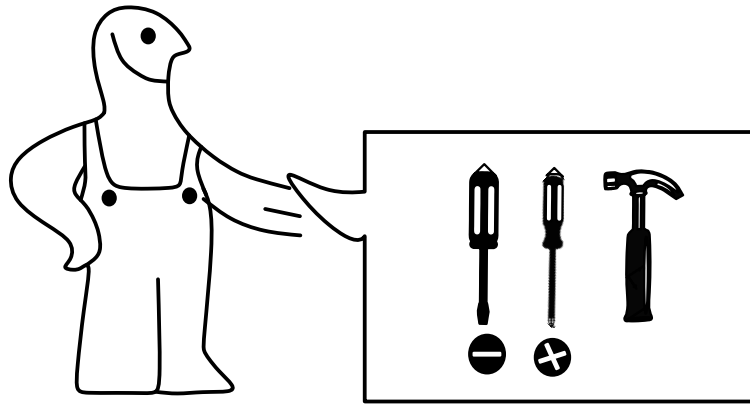

2

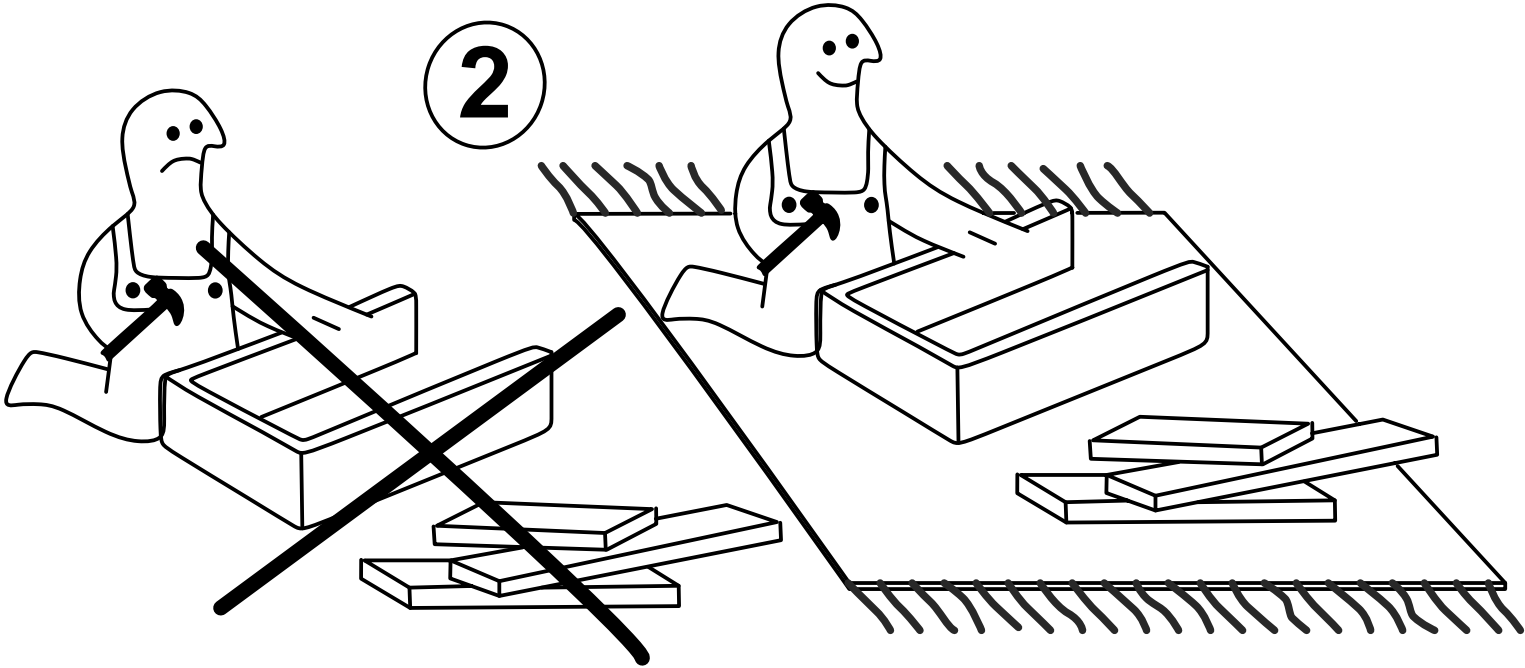

3



4

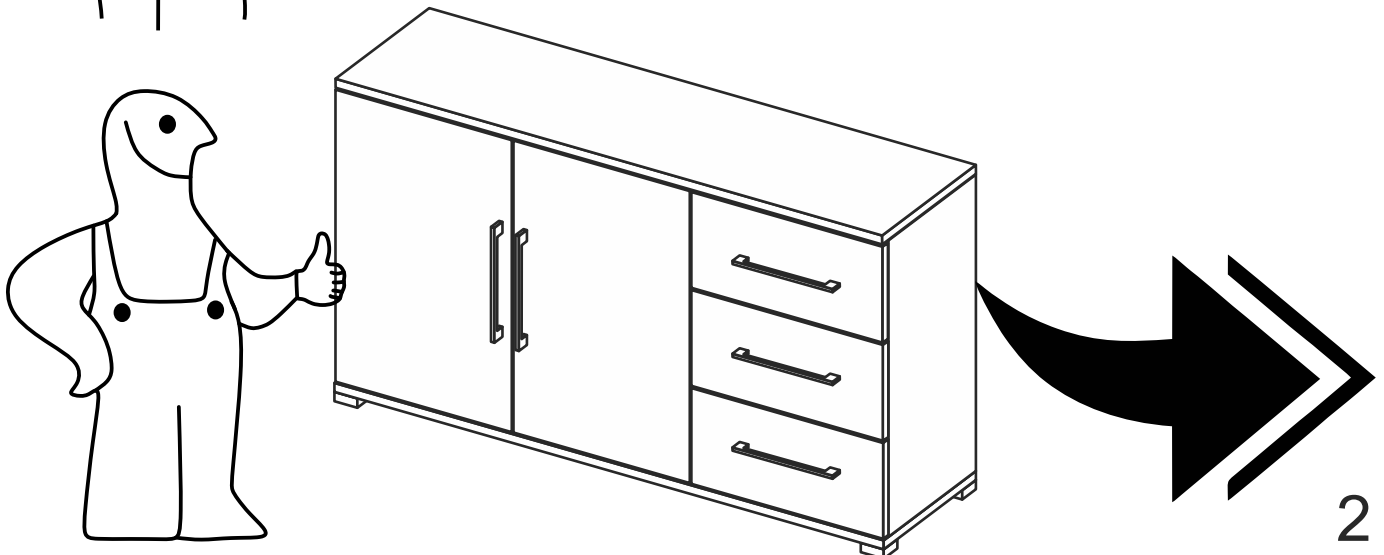

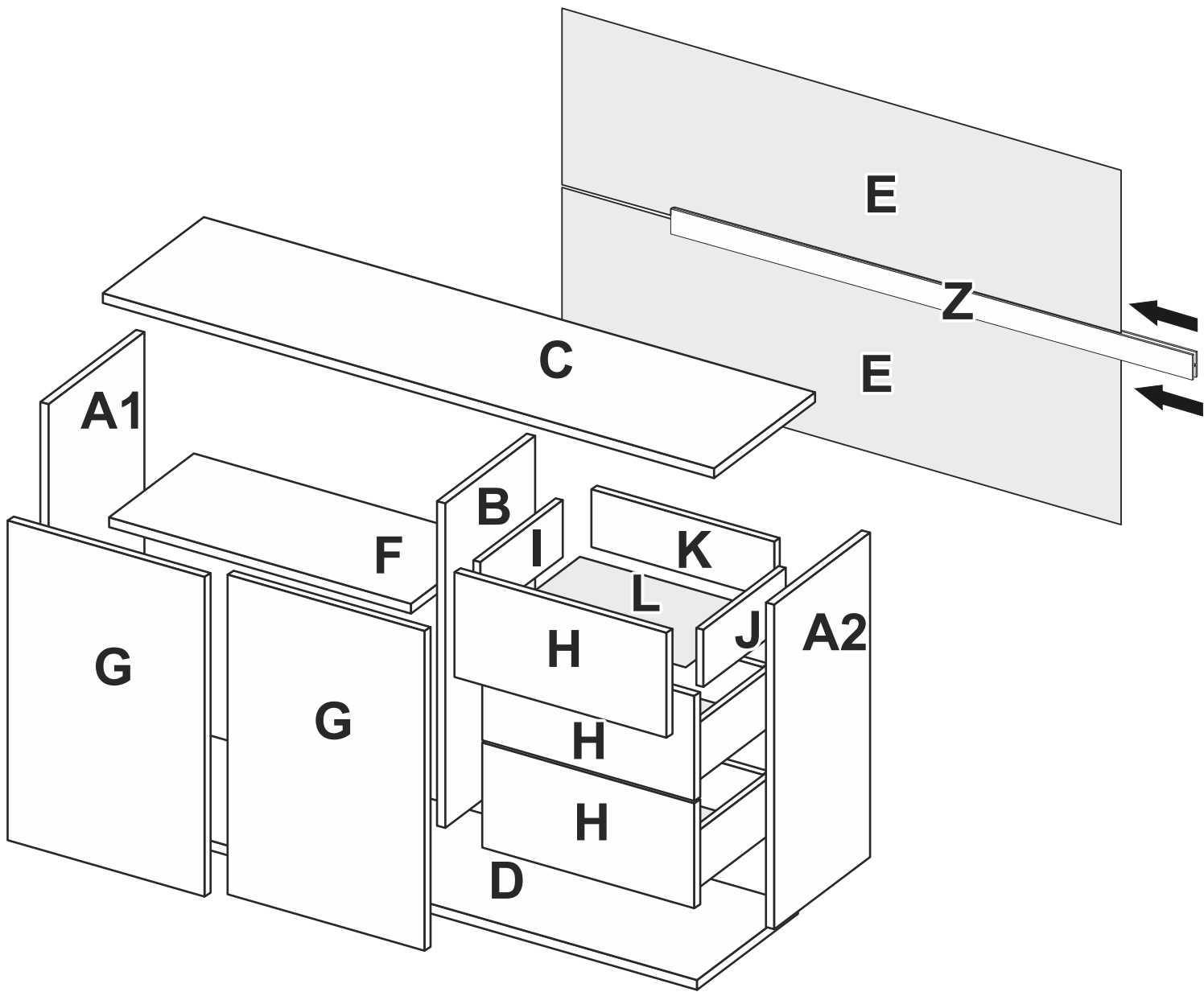

A1	-	754	x	380	x	16	-	x	1
A2	-	754	x	380	x	16	-	x	1
B	-	754	x	366	x	16	-	x	1
C	-	1458	x	400	x	22	-	x	1
D	-	1458	x	397	x	22	-	x	1
E	-	1437	x	383	x	3	-	x	2
F	-	891	x	346	x	16	-	x	1
G	-	453	x	746	x	16	-	x	1
G1	-	453	x	746	x	16	-	x	1
H	-	537	x	246	x	16	-	x	3
I	-	350	x	136	x	16	-	x	3
J	-	350	x	136	x	16	-	x	3
K	-	460	x	136	x	16	-	x	3
L	-	472	x	346	x	3	-	x	3
Z	-	1423MM						x	3

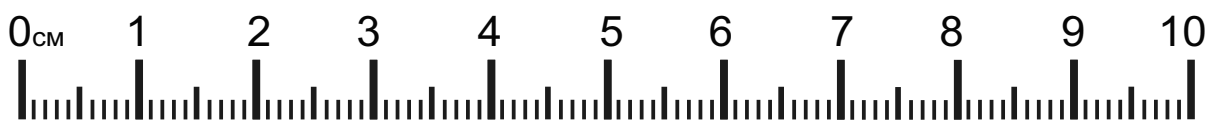
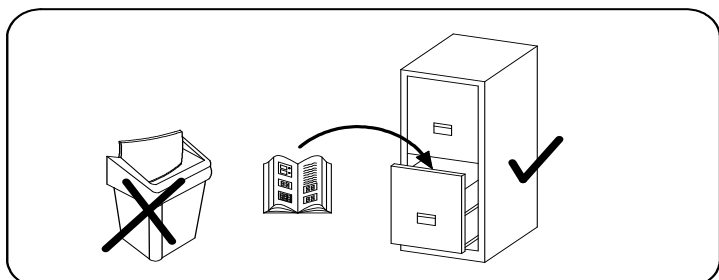
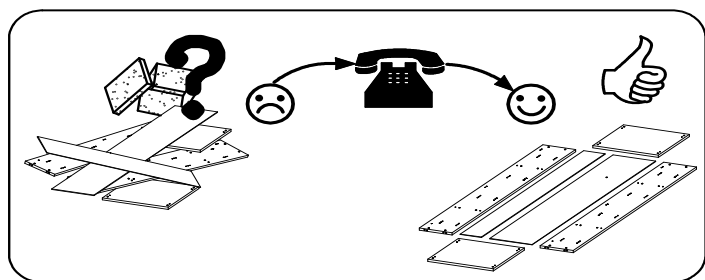
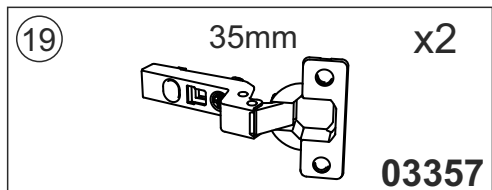
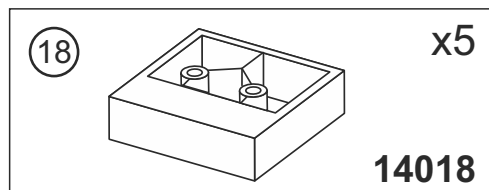
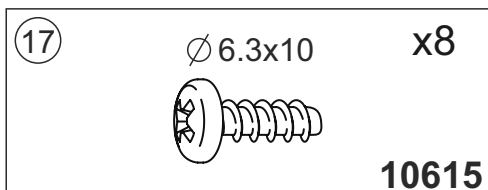
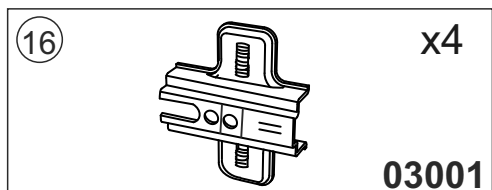
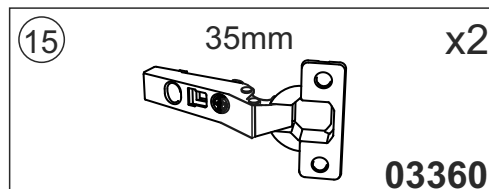
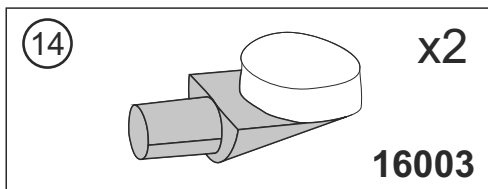
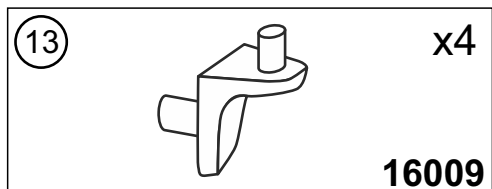
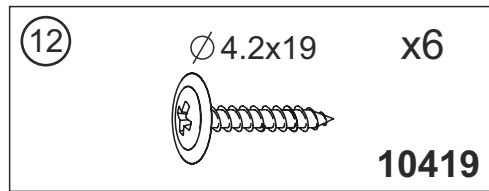
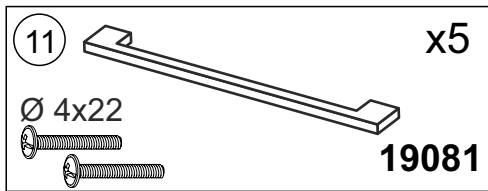
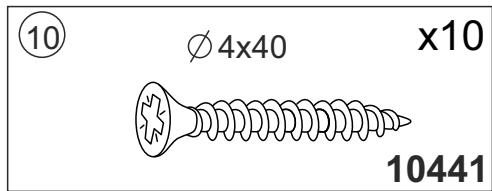
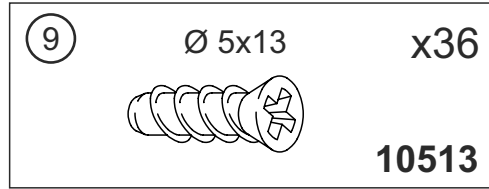
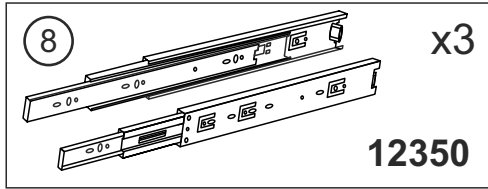
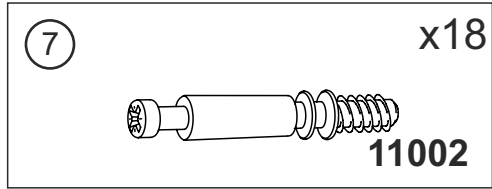
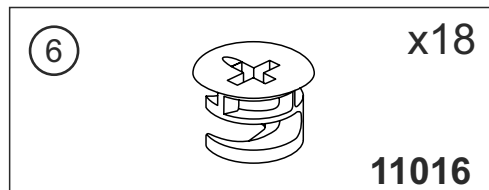
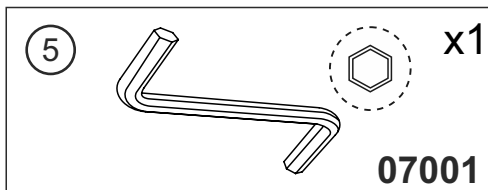
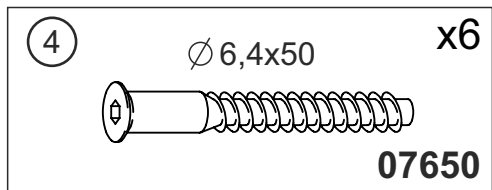
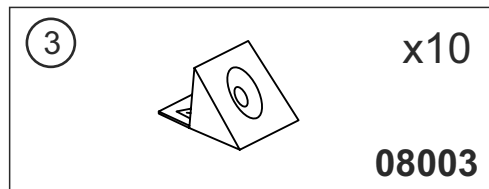
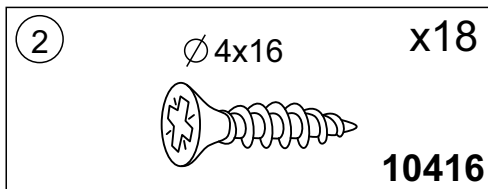
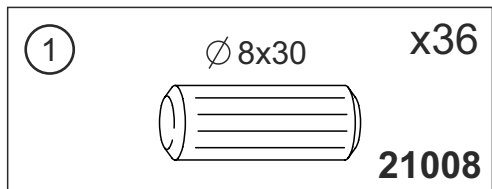

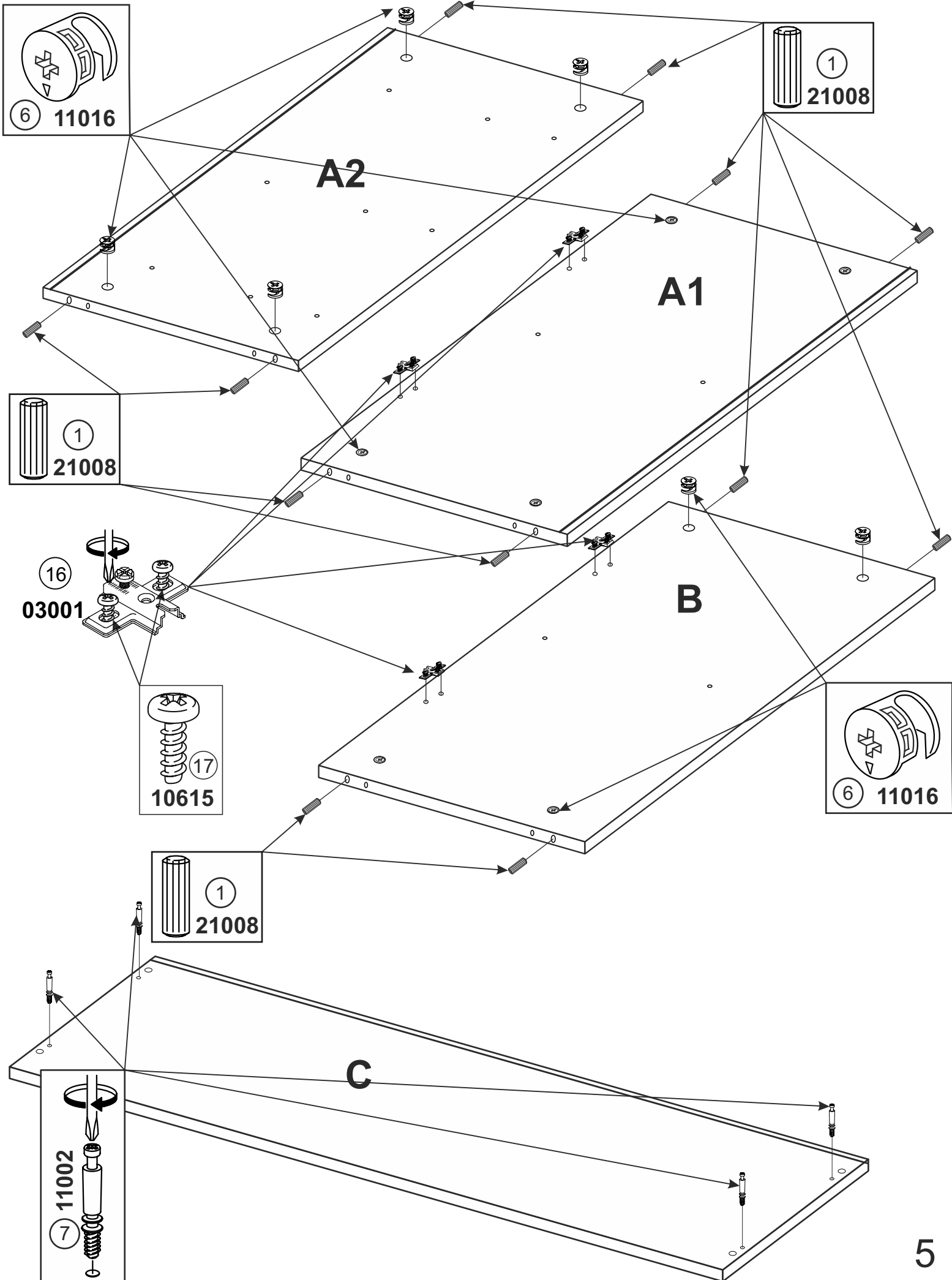

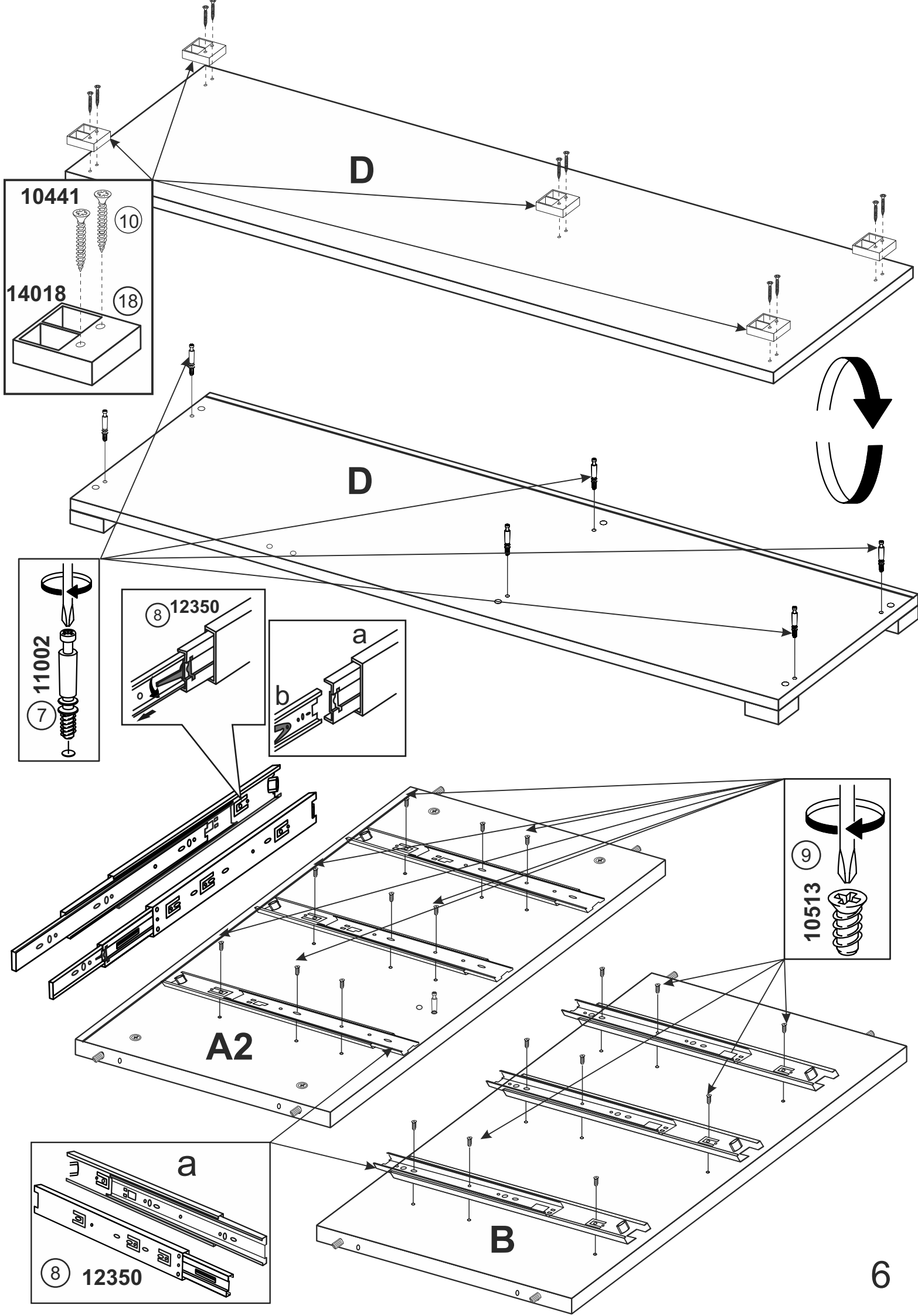

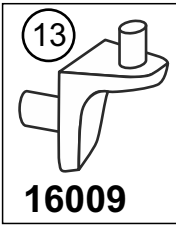
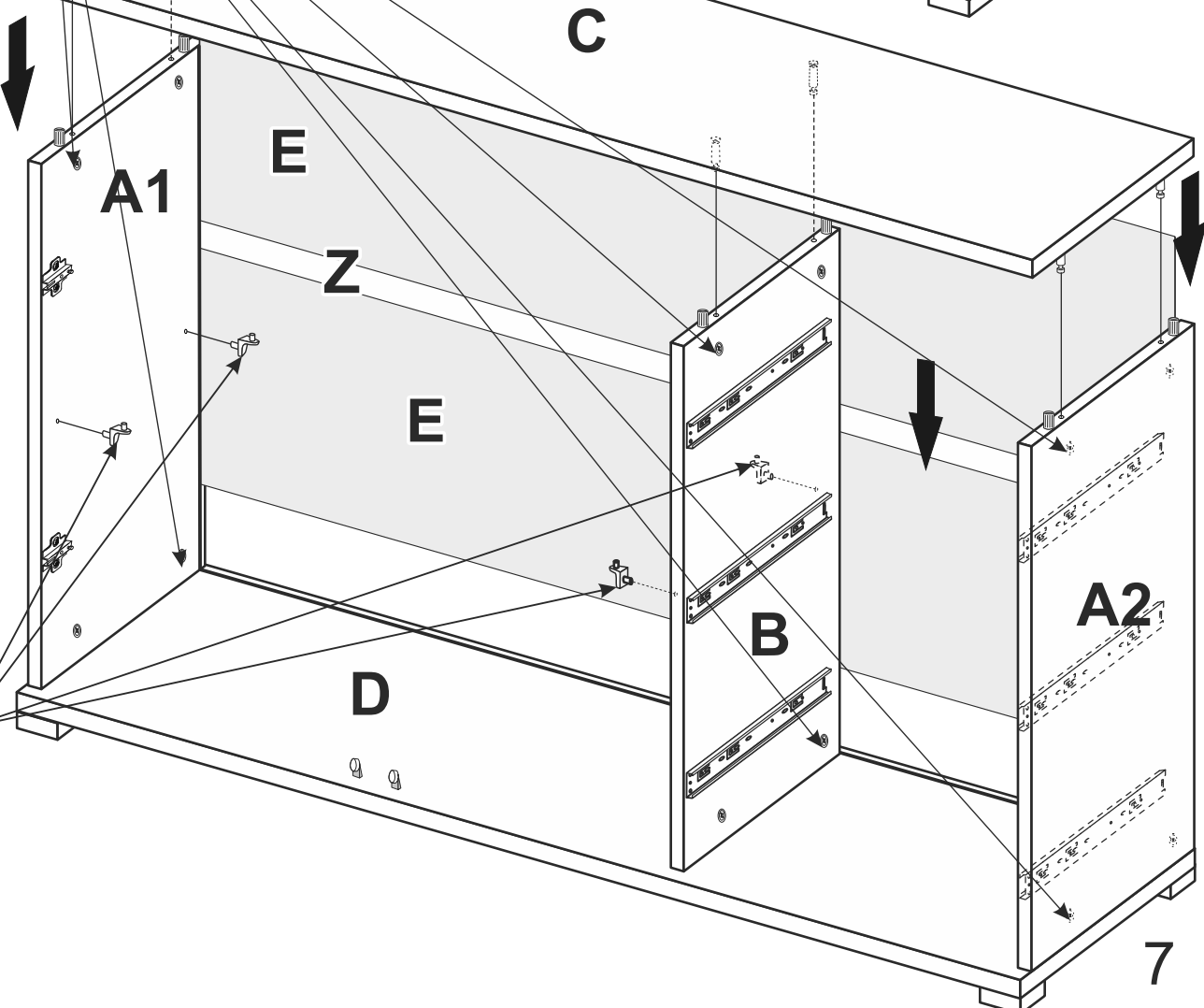
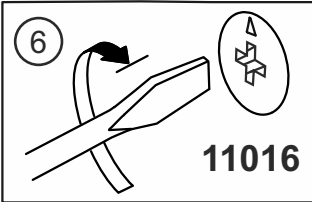
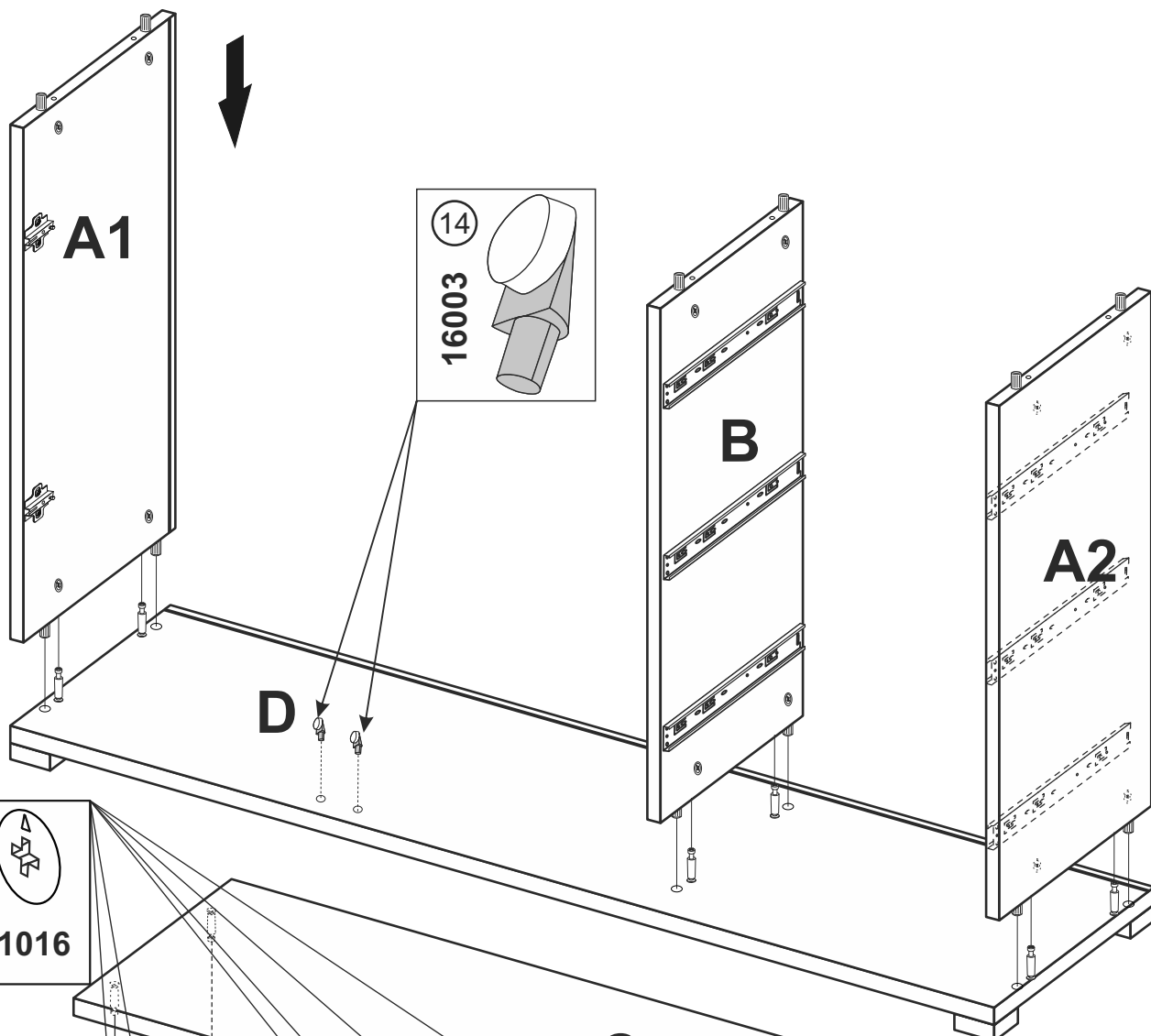

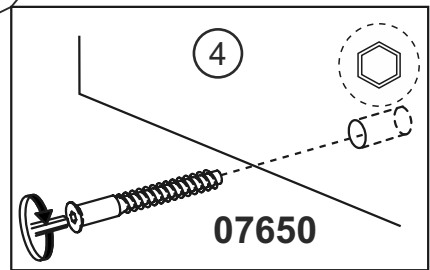
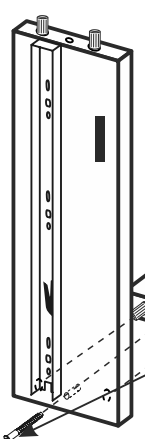
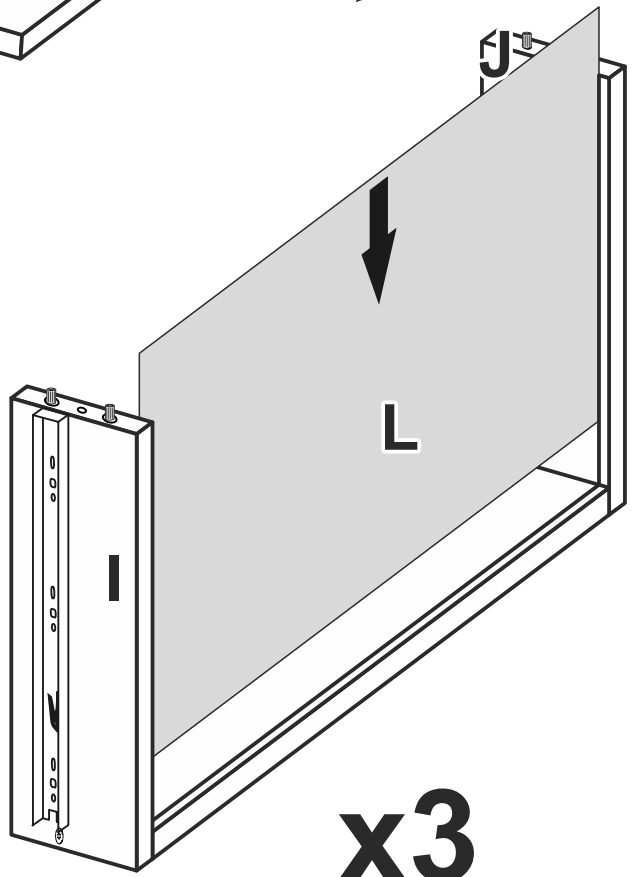
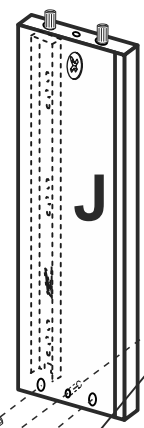
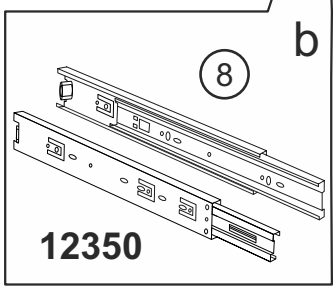
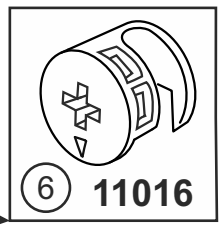
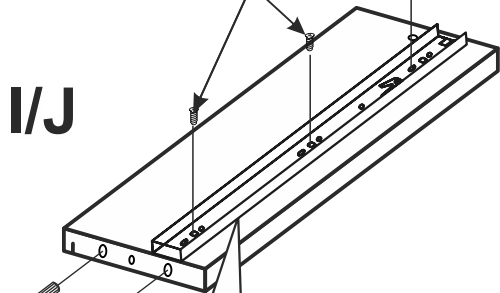
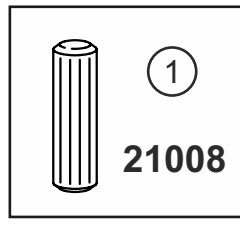
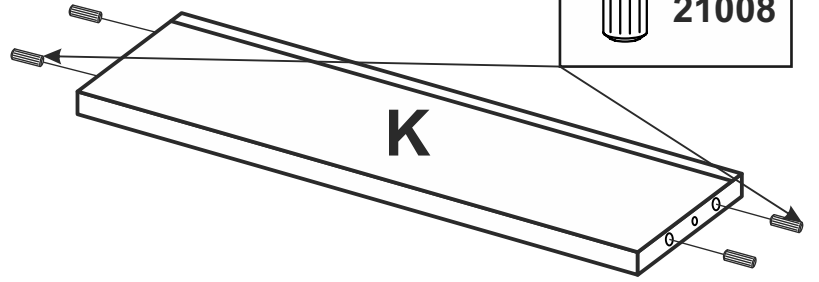
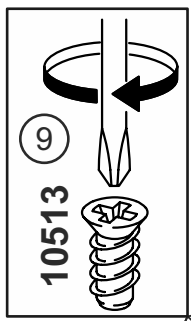
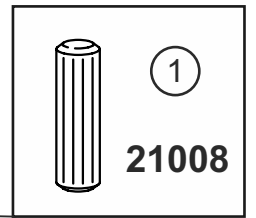
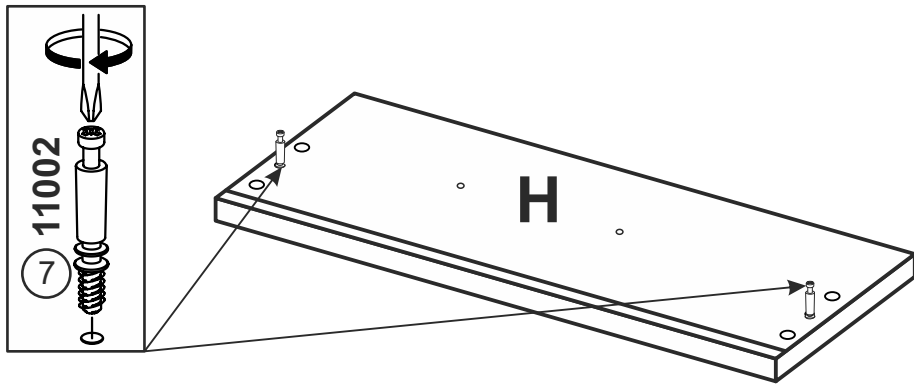

x3

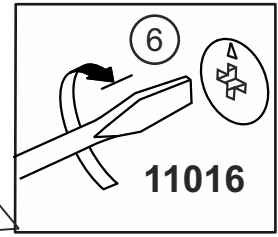
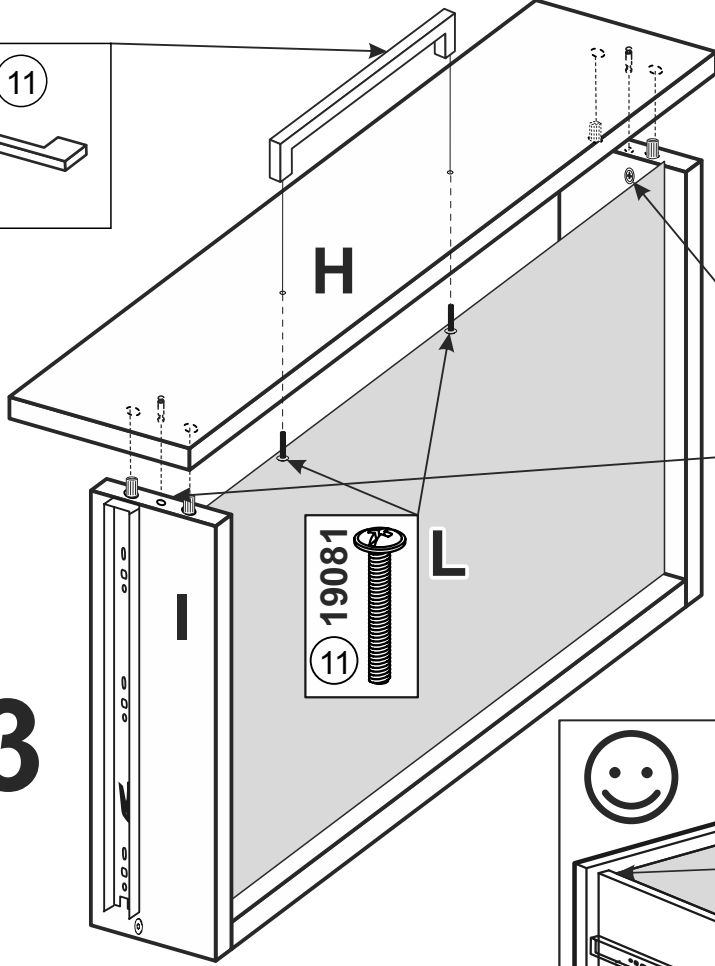
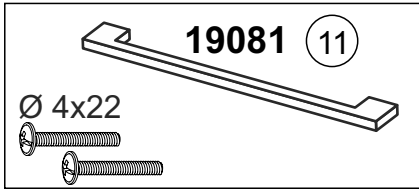

x3

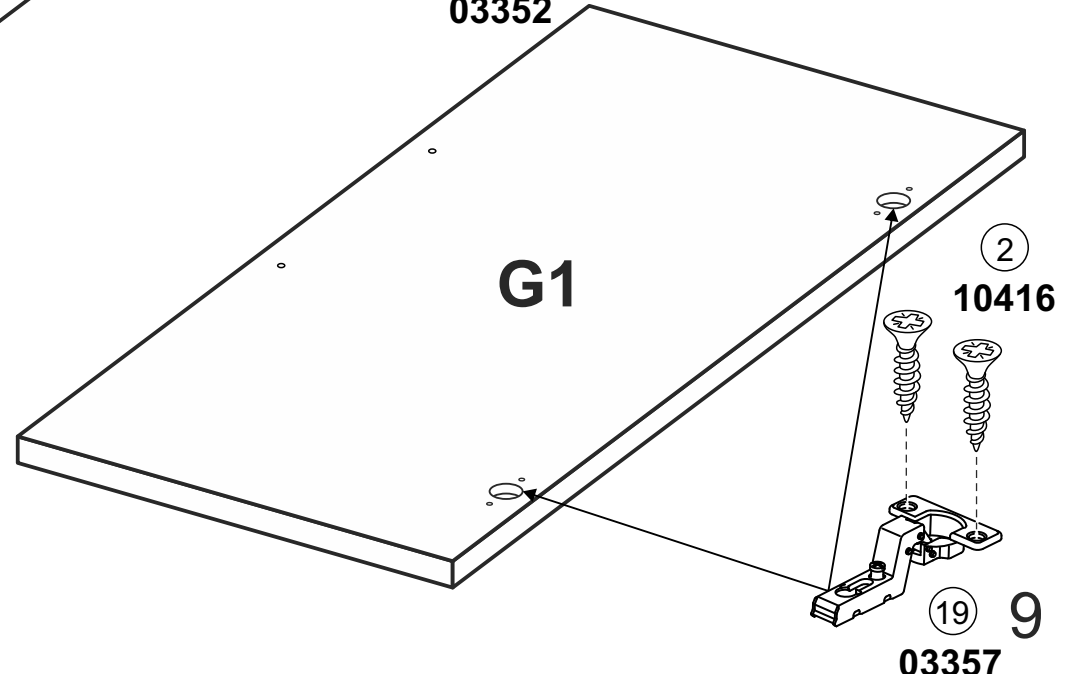
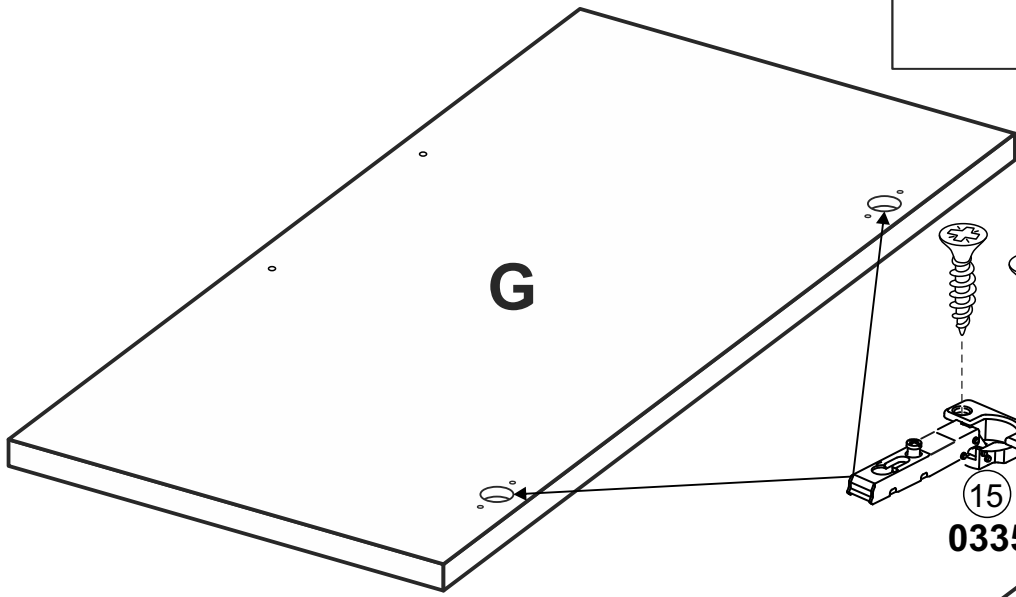
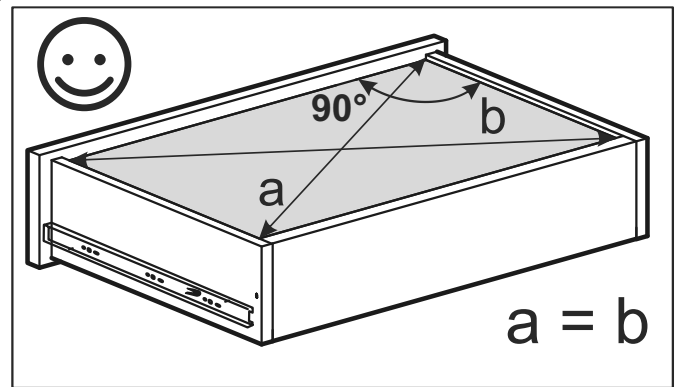

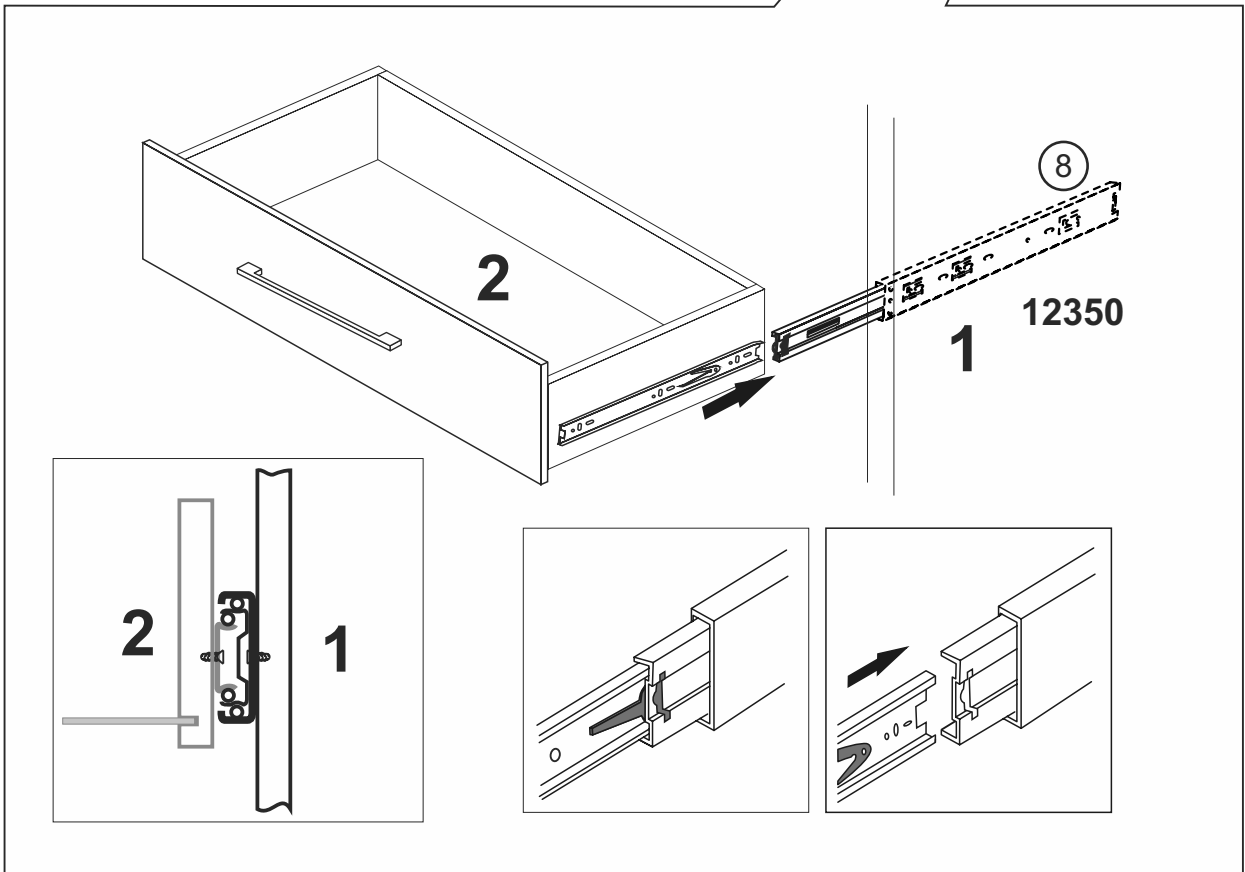
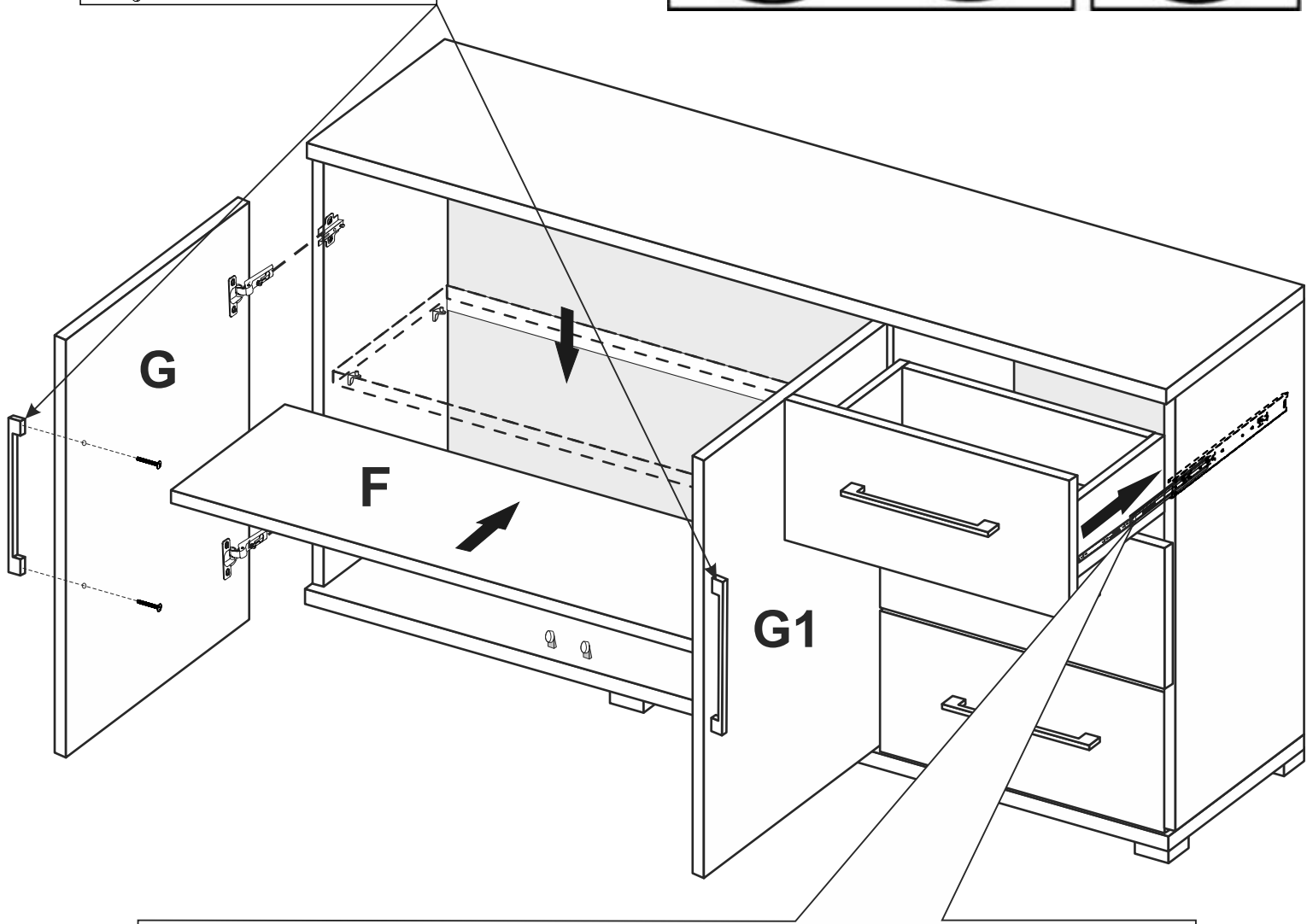
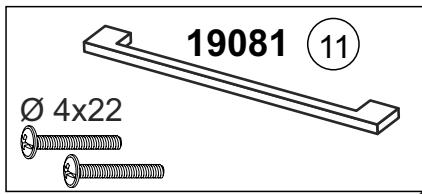

X
90°

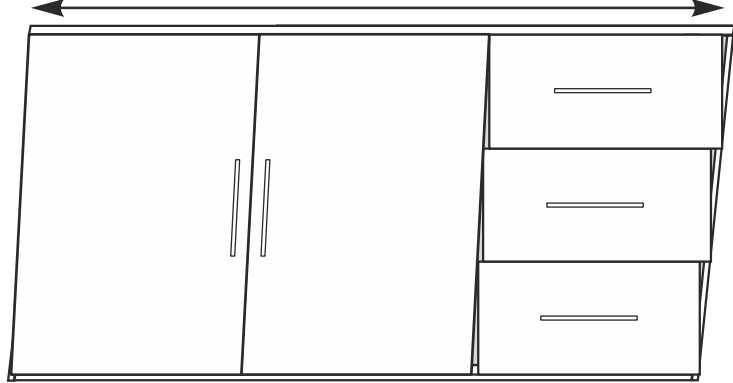
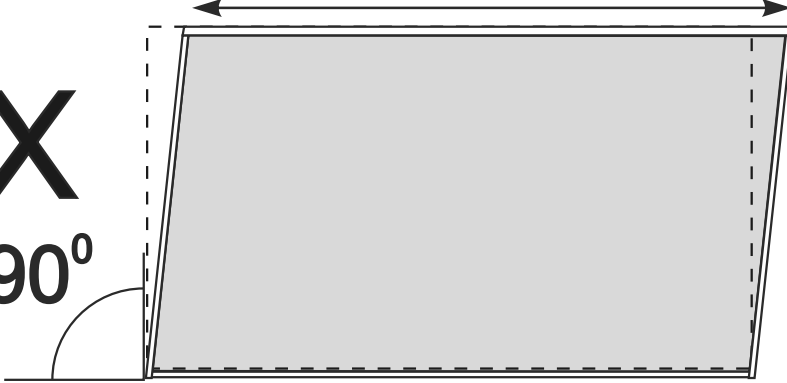

✓
90°

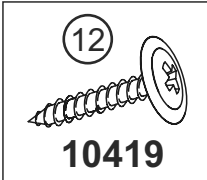
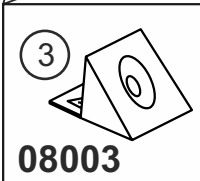
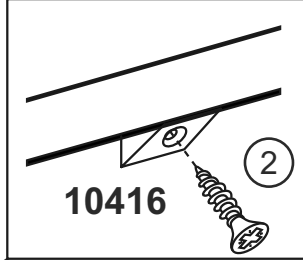
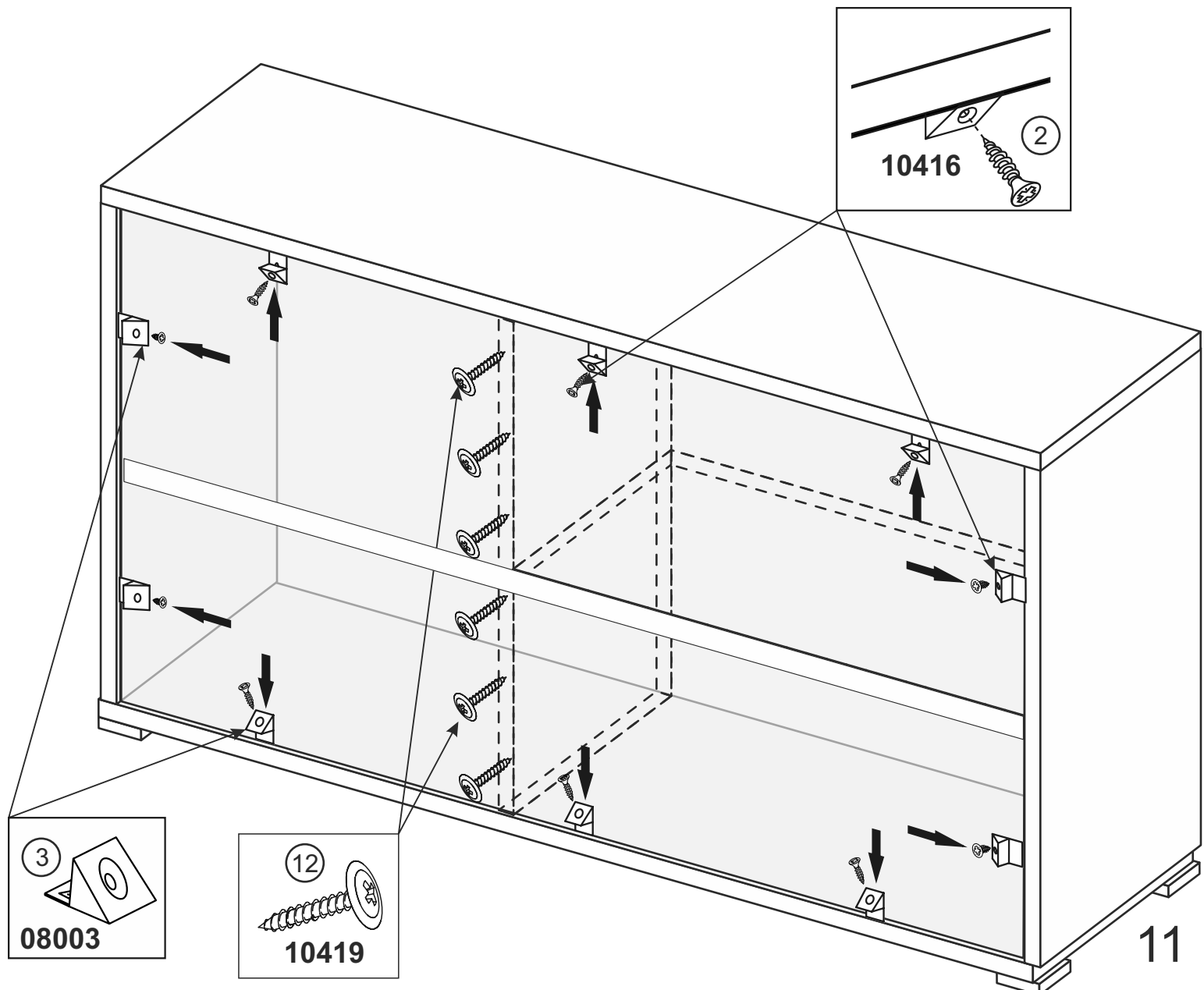
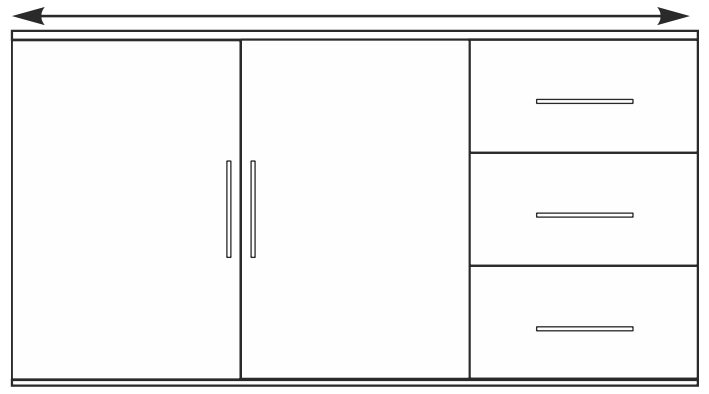
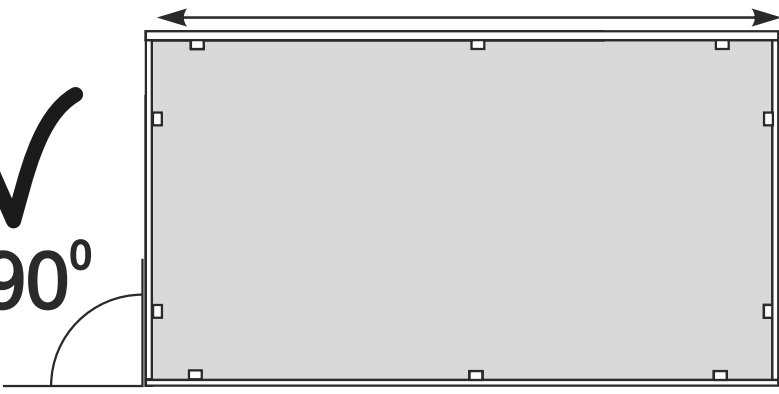

11