

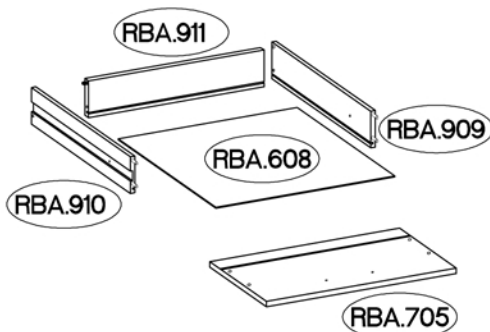

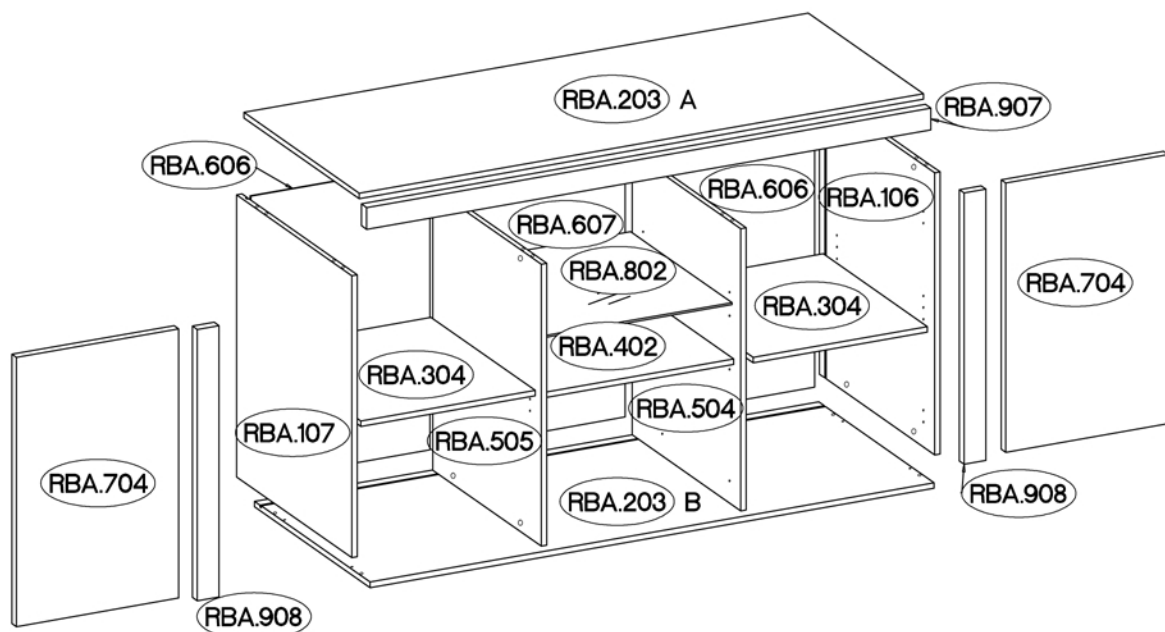





















REINA



		
±20/8mm	±10x50mm	
J14	O7	L9
8	2	2

				
±6,3x20mm	±6x42mm			±4.0x25mm
M3	B2	T9	F10	P14
8	4	9	6	6

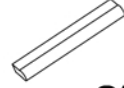
								
±3.5x13mm	±4.0x16mm	±4.0x30mm			M4x9mm		310/27mm	
L2	P5	P1	R2	J12	U1	O1	I	T4
10	10	26	8	4	4	1	2	2

									
	±3.0x20mm	L=20mm	±15/12mm	±8x30mm		L=128mm	±5/16mm	±35/0mm	
E	H	P7	D2	C	A	L	S1	J3	G
16	4	13	20	20	16	14	4	8	4

310/27mm I 2	 T4 2	±8x30mm A 16	±15/12mm C 20	L=20mm D2 20	±6,3x20mm M3 8	 F10 6	±4.0x25mm P14 6	±4.0x16mm P1 13
 T9 9	±20/8mm J14 8							

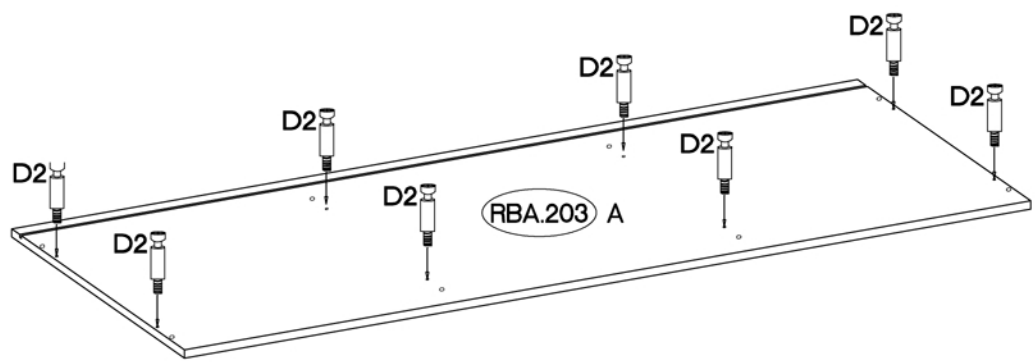
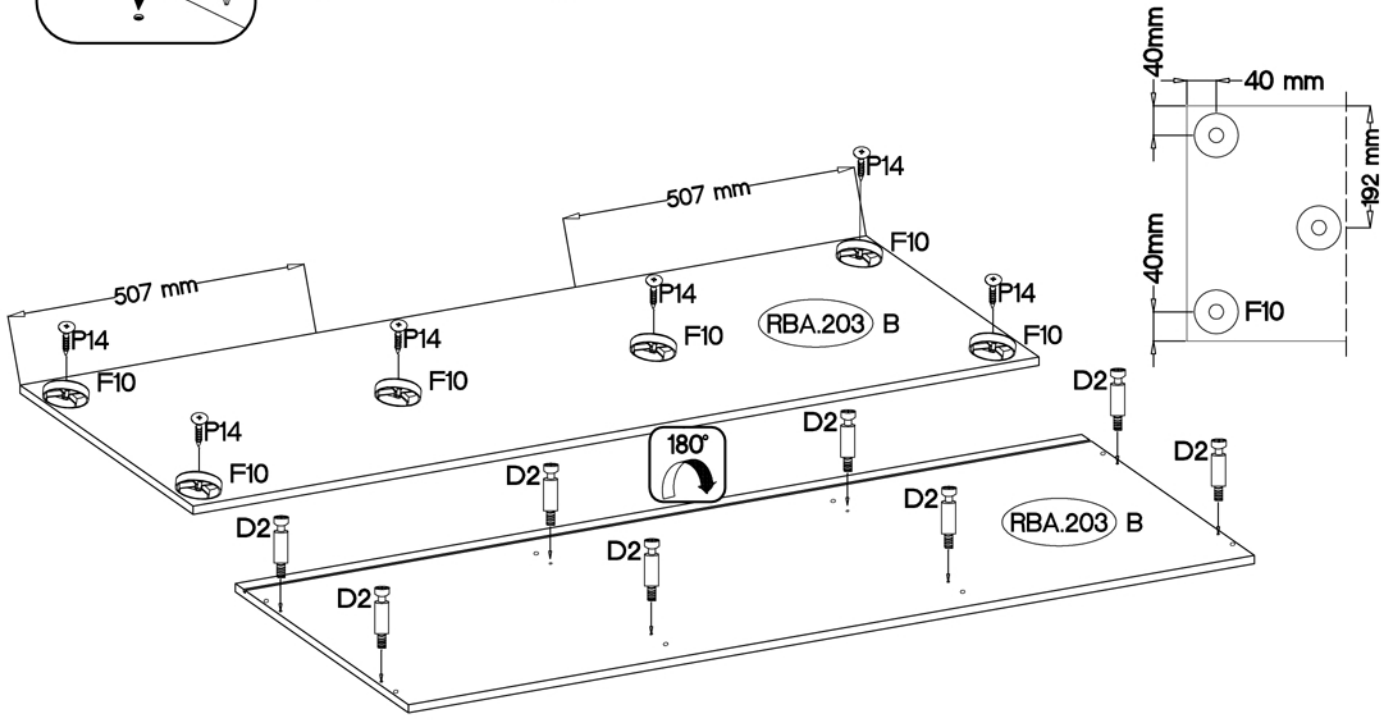
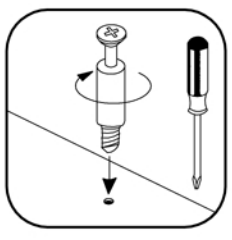
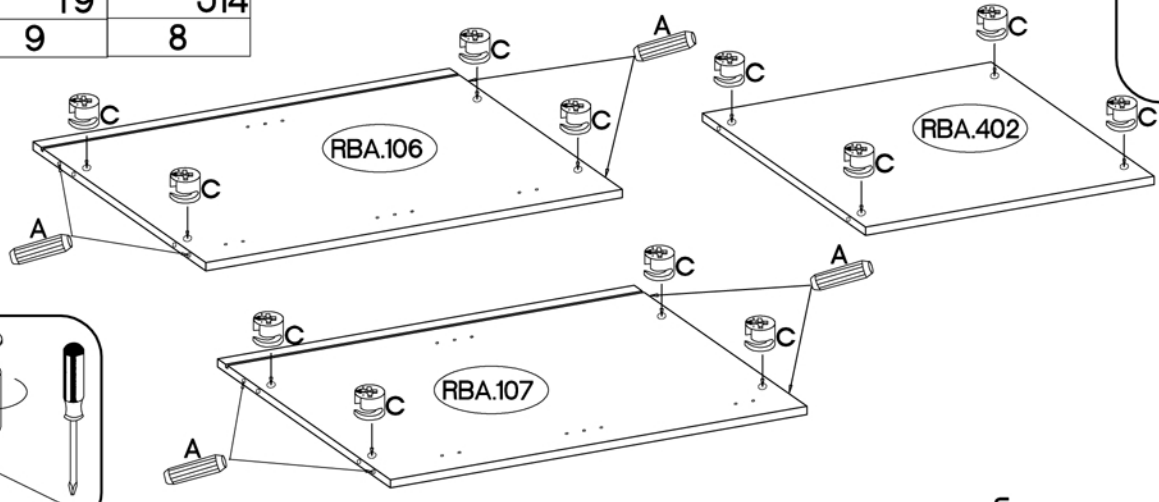

1

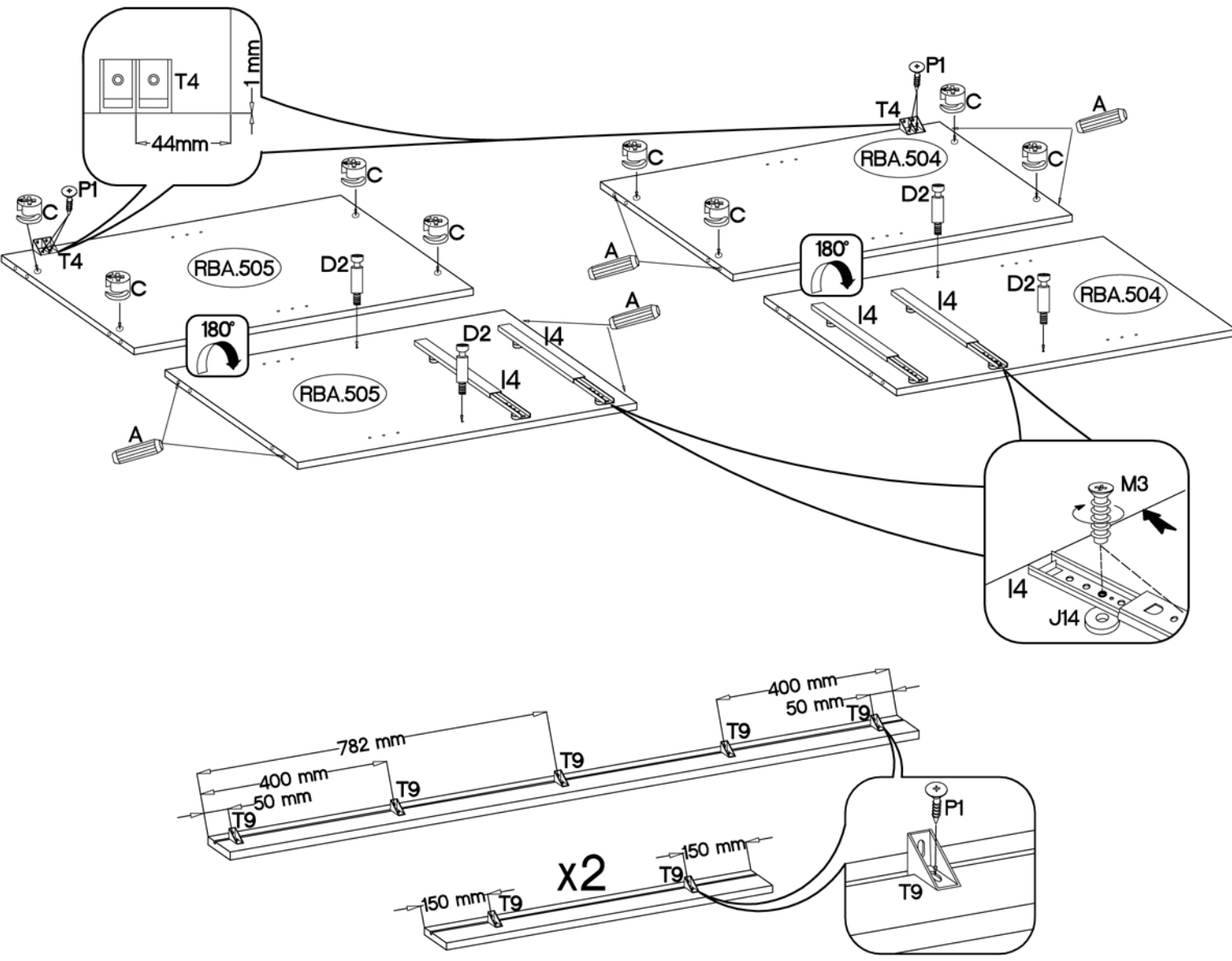

2

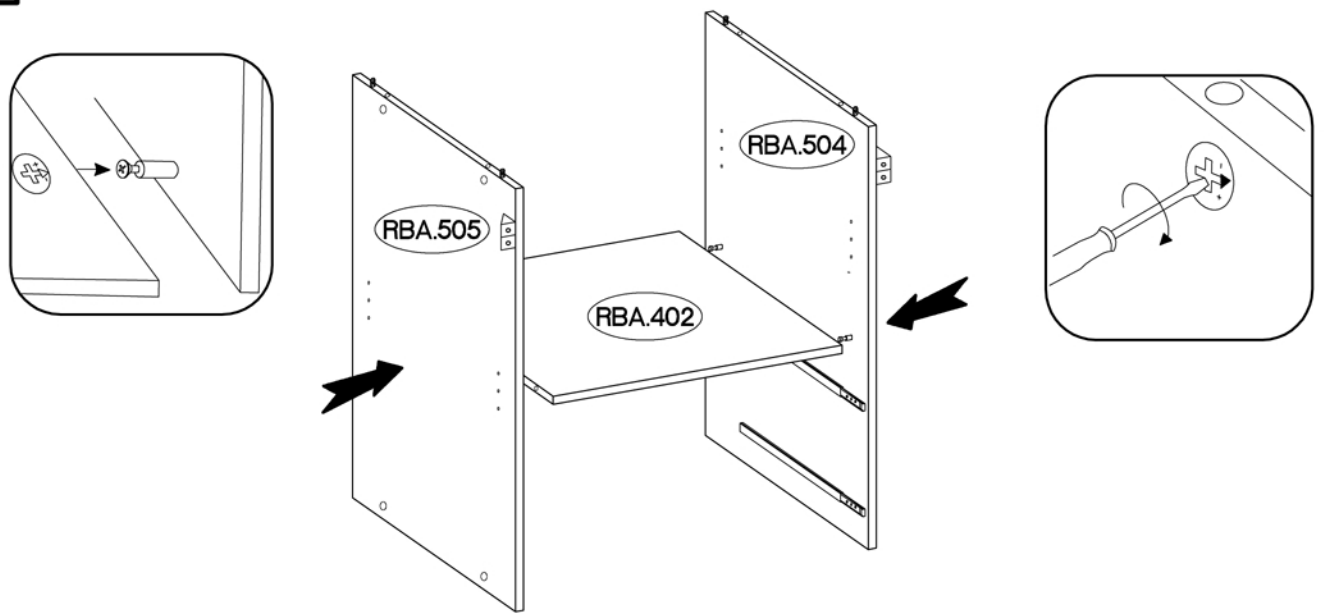

3

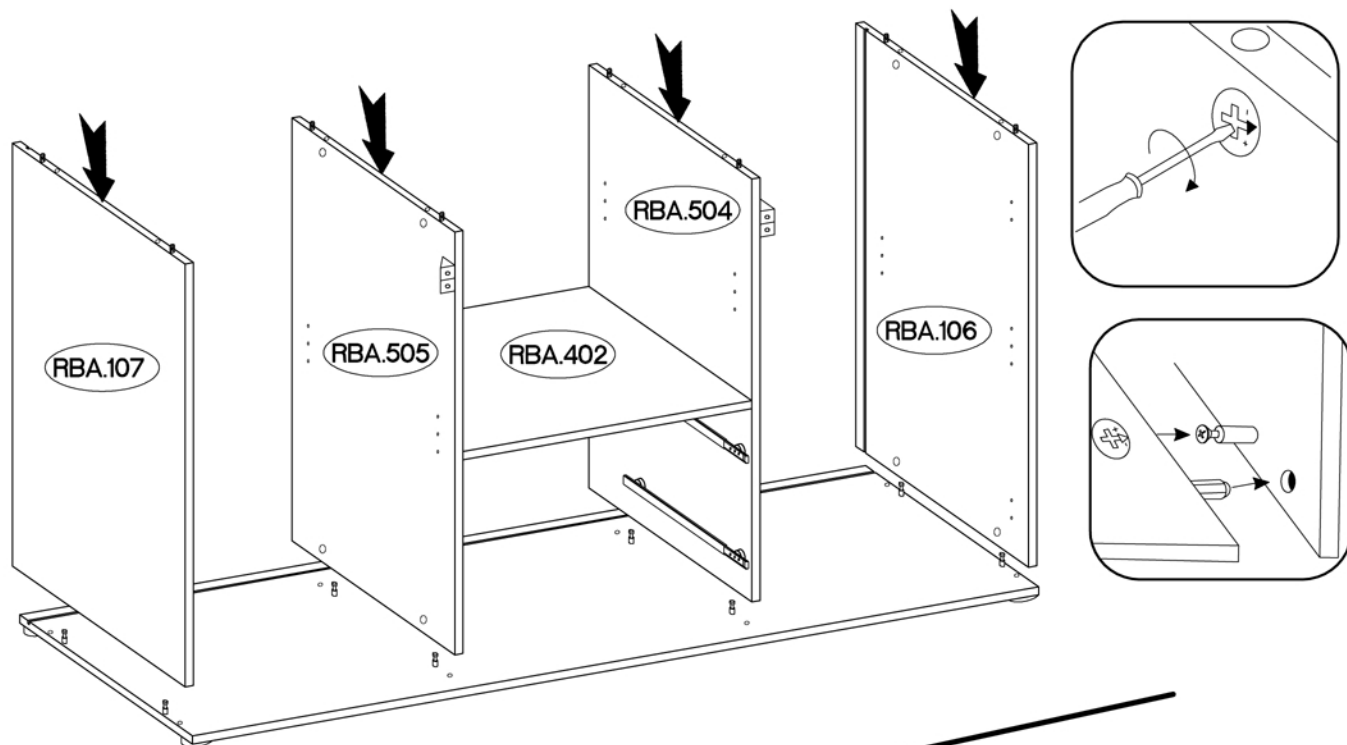

4

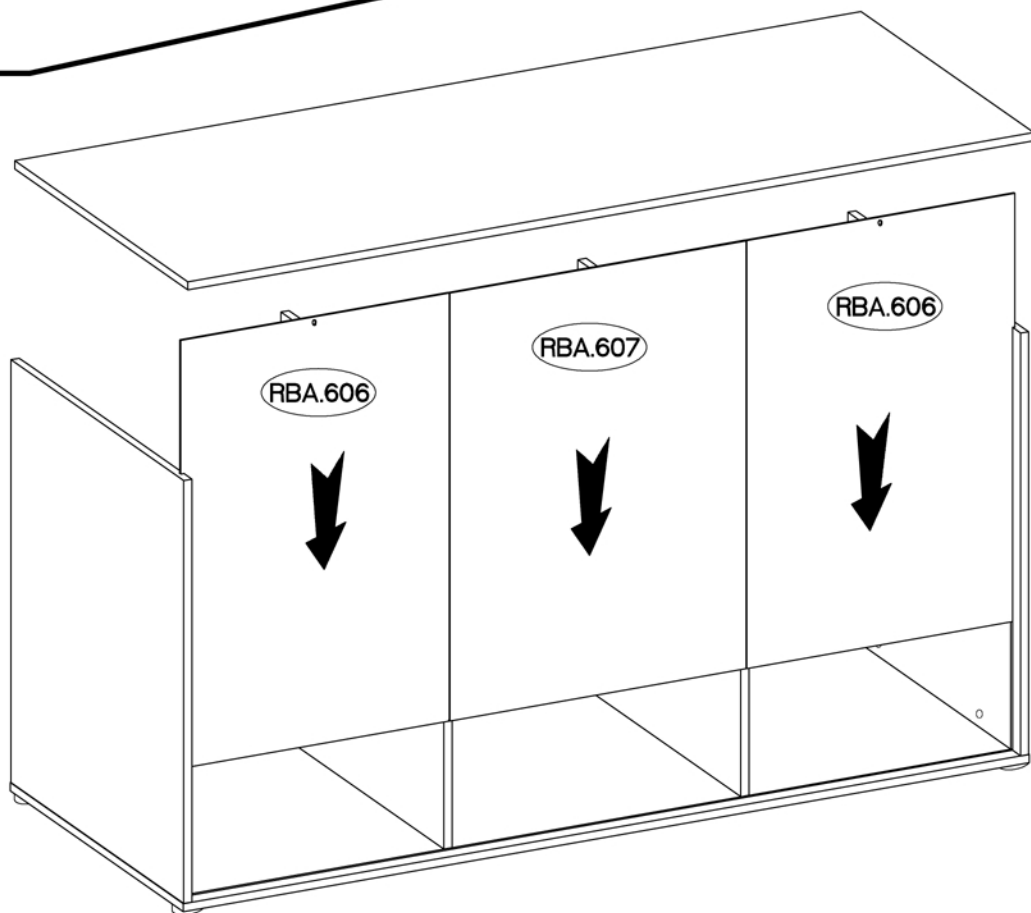
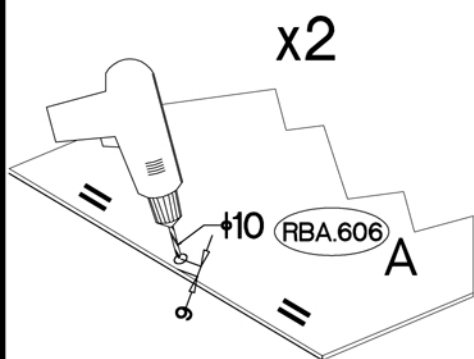

5

±3.0x20mm



P7

13

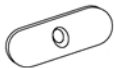

L2

10



L

10

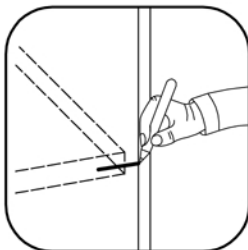
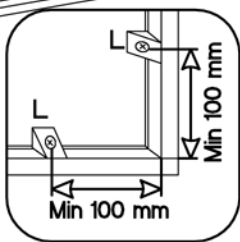
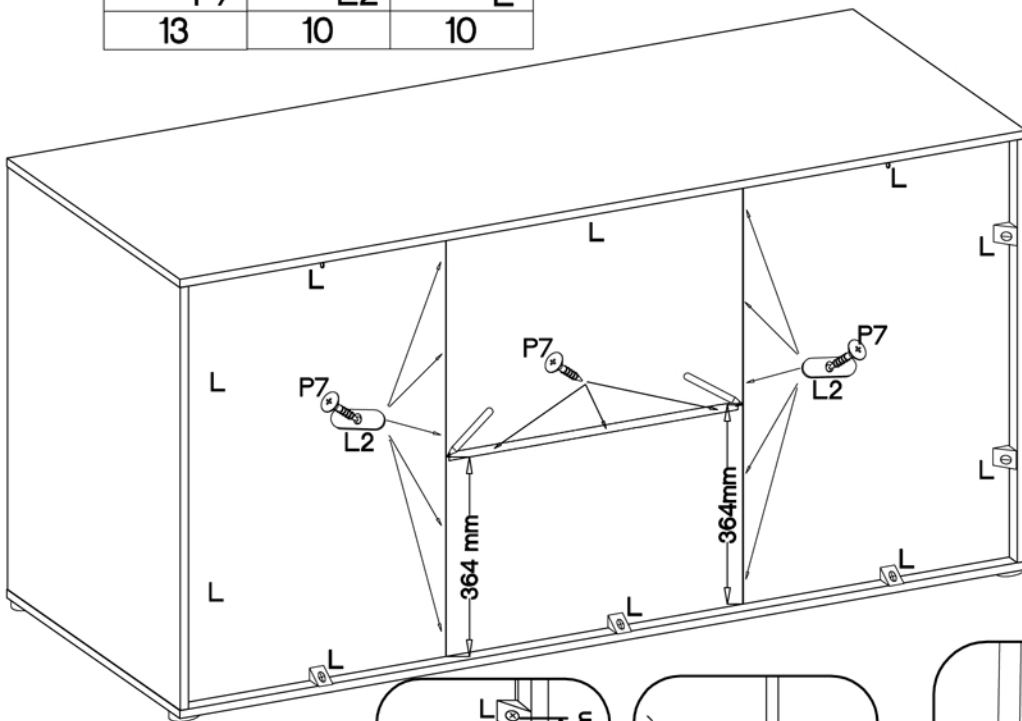

A

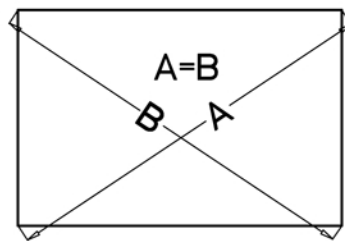

B

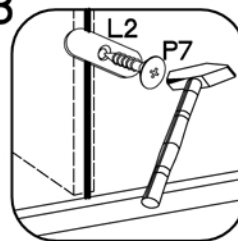

C

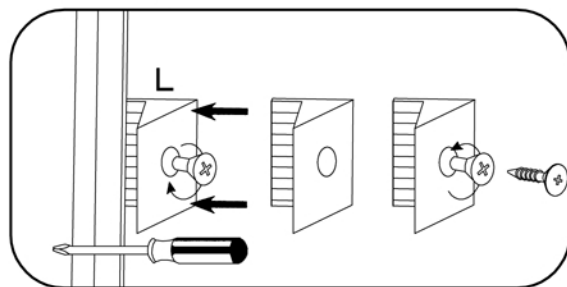

6

±4.0x16mm



P1

13

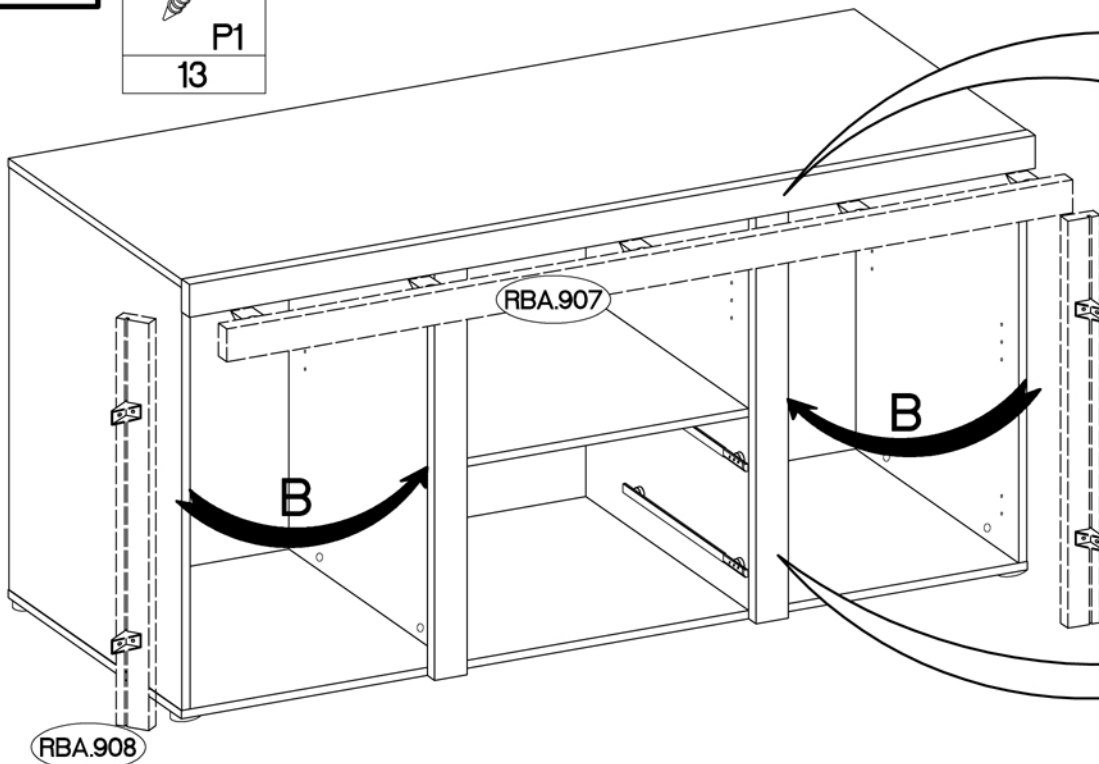

x2

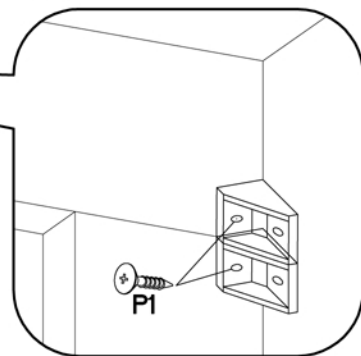

RBA.908

RBA.907

RBA.908

x9



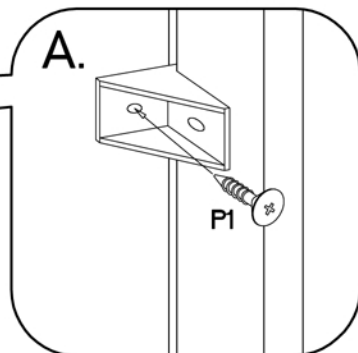

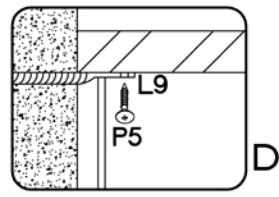
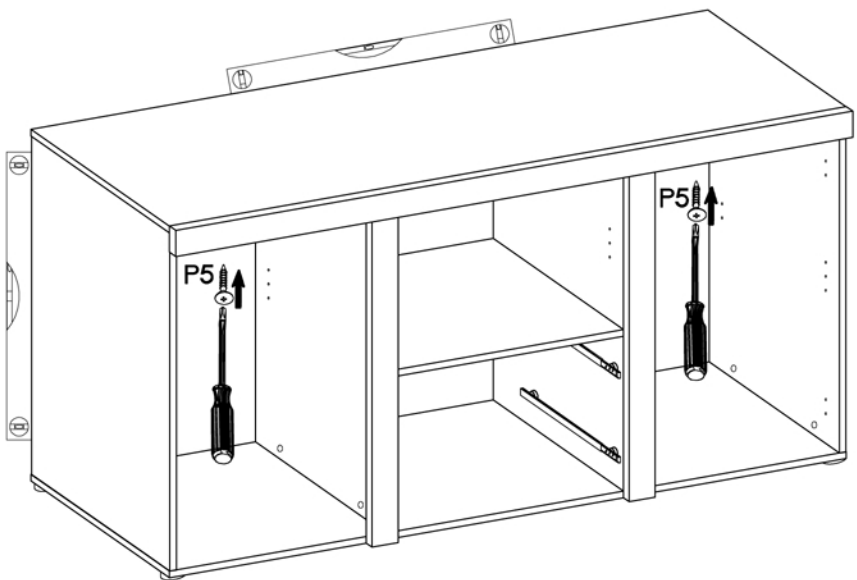
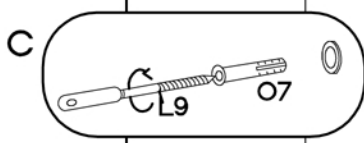
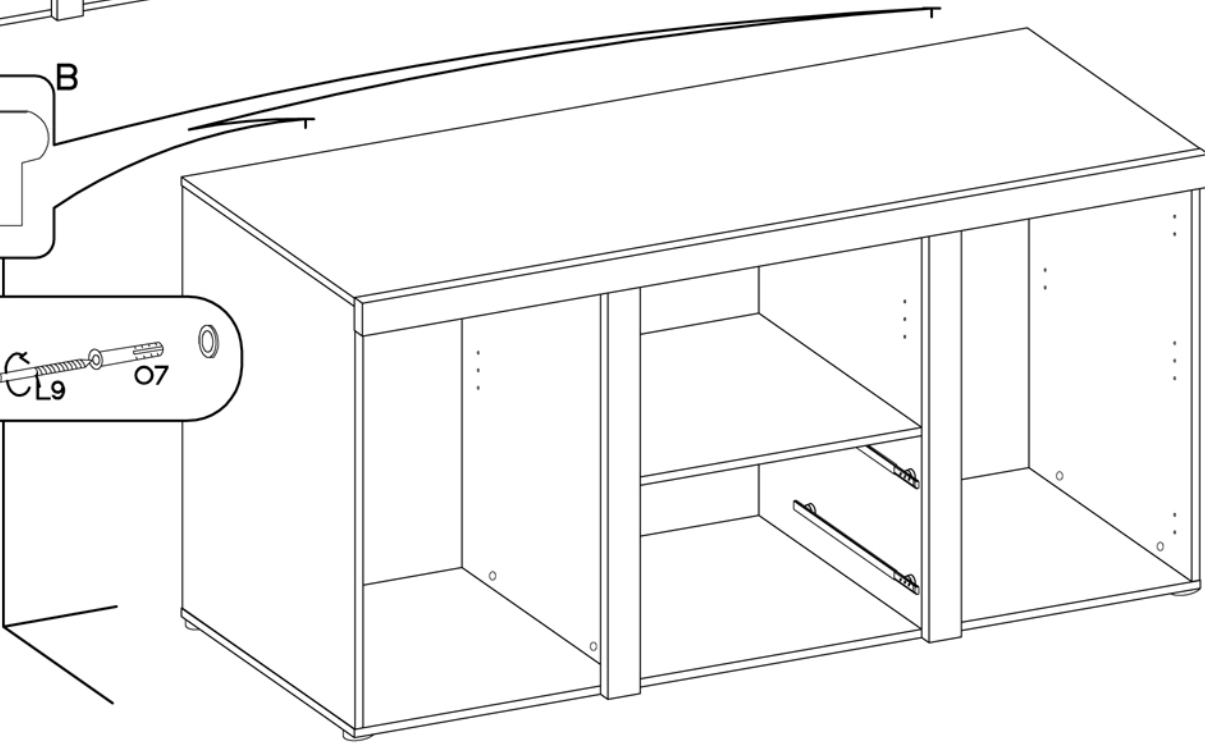
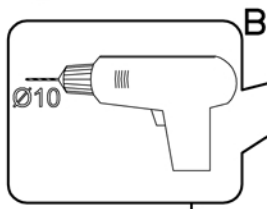
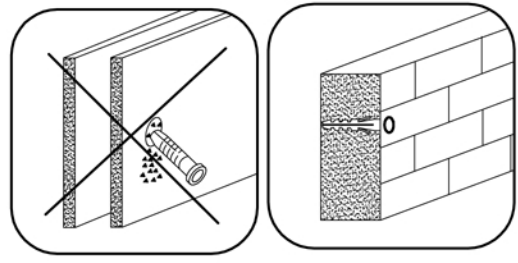
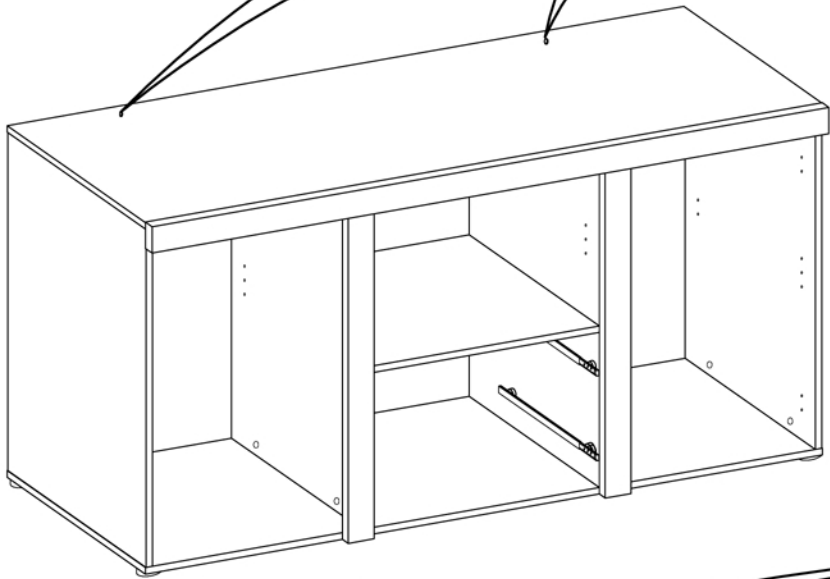
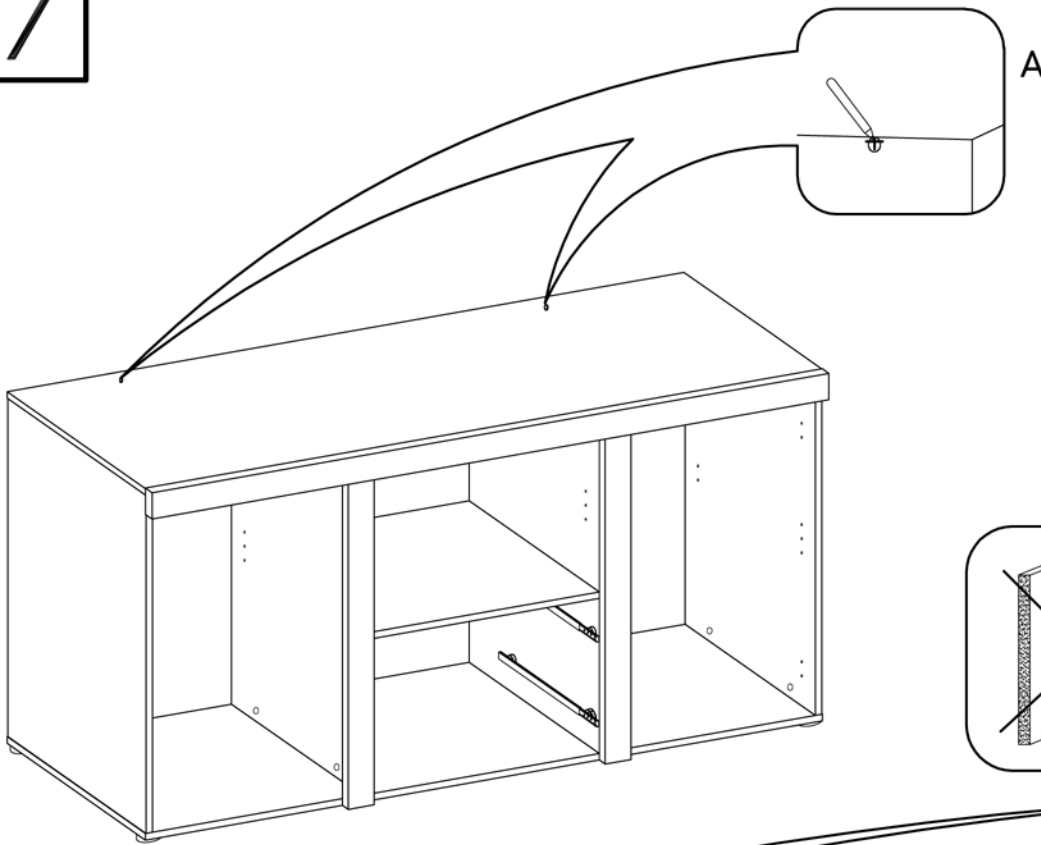
A.





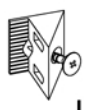

±10x50mm		±3.5x13mm
O7	L9	P5
2	2	2

8

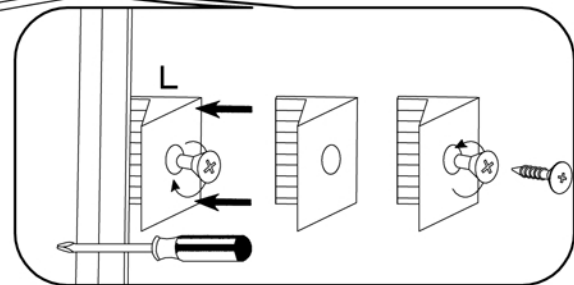
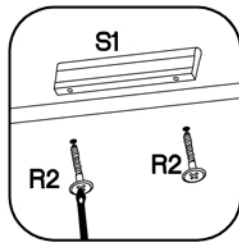
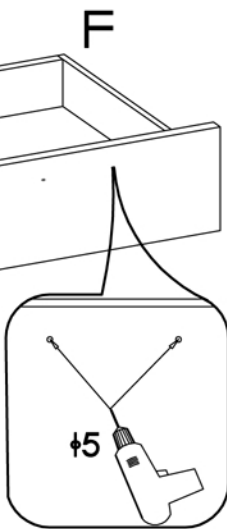
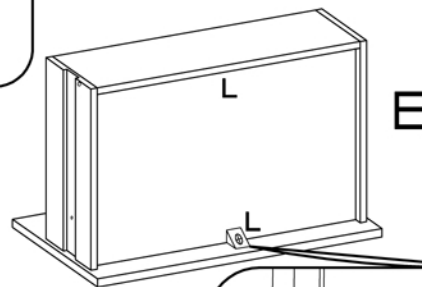
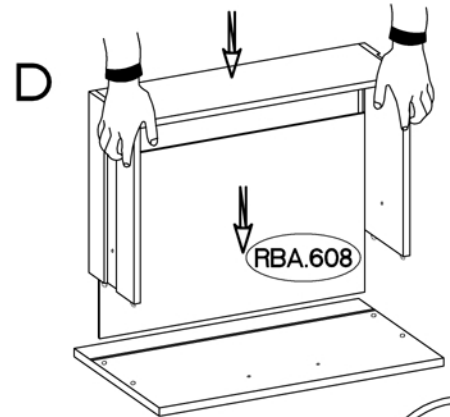
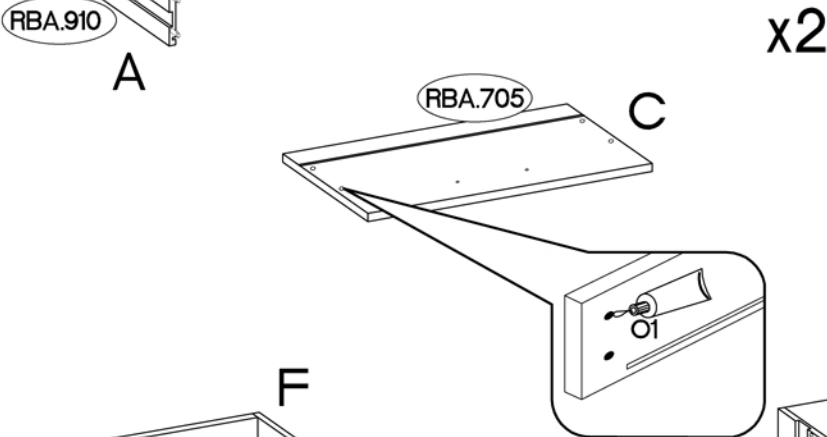
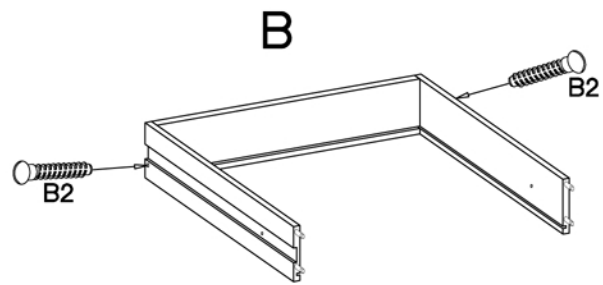
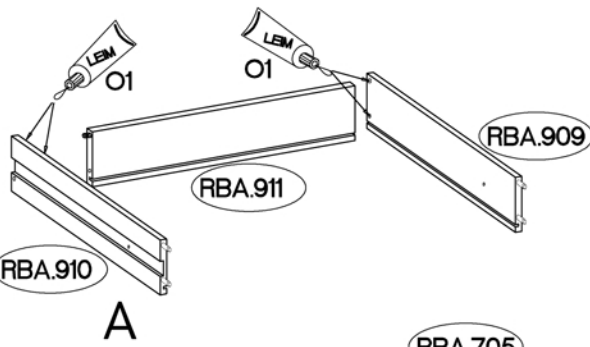



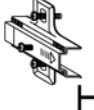

$\pm 6 \times 42 \text{mm}$  B2 4	 O1 1	L=128mm  S1 2	$\pm 4.0 \times 30 \text{mm}$  R2 4	 L 4
--	---	--	--	--

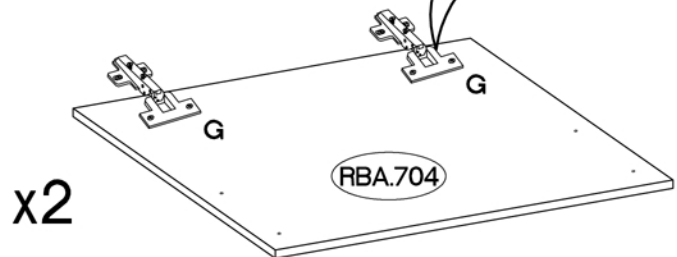
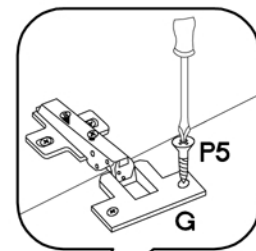
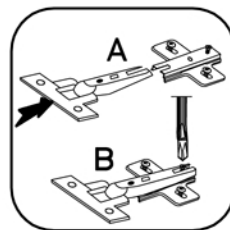

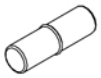
9

H=0  H 4	$\pm 35 / 0 \text{mm}$  G 4	$\pm 3.5 \times 13 \text{mm}$  P5 8
--	---	---



$\pm 5/16\text{mm}$  J3 8	 J12 4	$L=128\text{mm}$  S1 2	$\pm 4.0 \times 30\text{mm}$  R2 4	$M4 \times 9\text{mm}$  U1 4	 E 16
---	---	--	--	--	---

