

NANCY 801

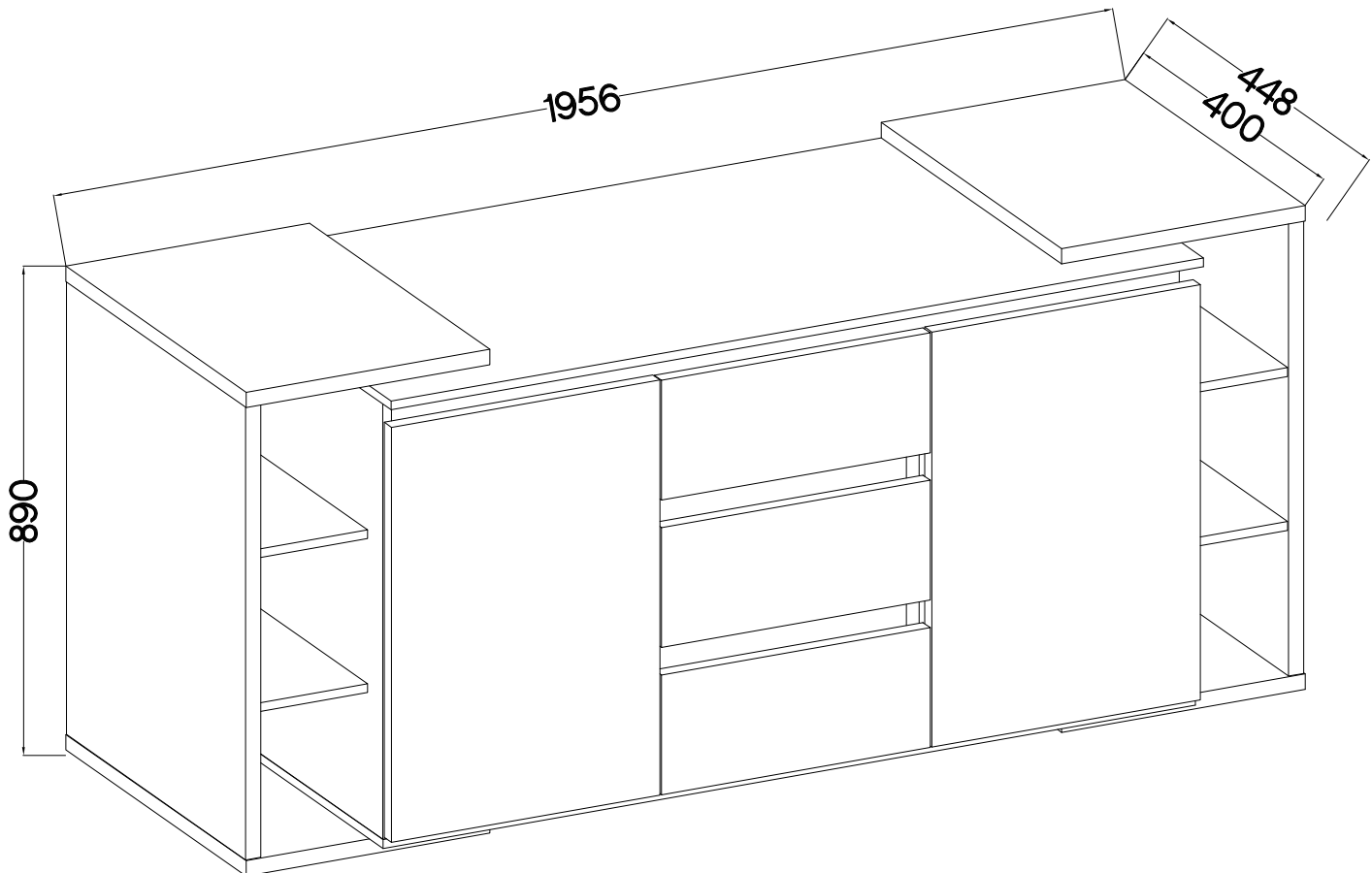
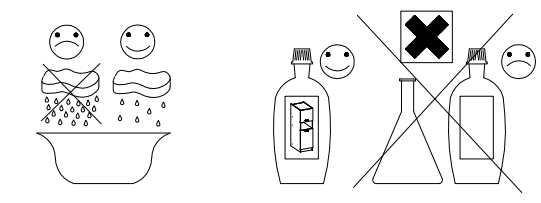

†8x30mm A	6,4 x 50mm B	†6x42mm B2	†15/12mm C	†12/10mm C5
60	6	6	46	6

L=20mm D2	ant. E	szar. E	 E1	 E13	60x49x10 F28	†35/0mm HG	27/310mm I4	†5/16mm J3	†6,3x13mm M2	 L
52	14	28	4	4	8	4	3	8	12	24
 L2	 L9	 O	 O1	†10x50mm O7	†4.0x16mm P1	†3.5x13mm P5	†3.0x20mm P7	†3.5x25mm BLACK P25	 T3	M4x9mm U1
10	2	1	1	2	20	10	10	8	2	6

ISM-NOA-001

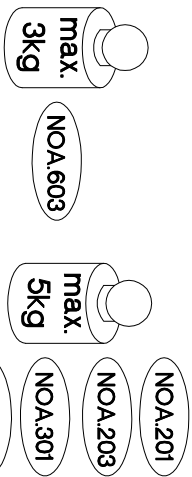
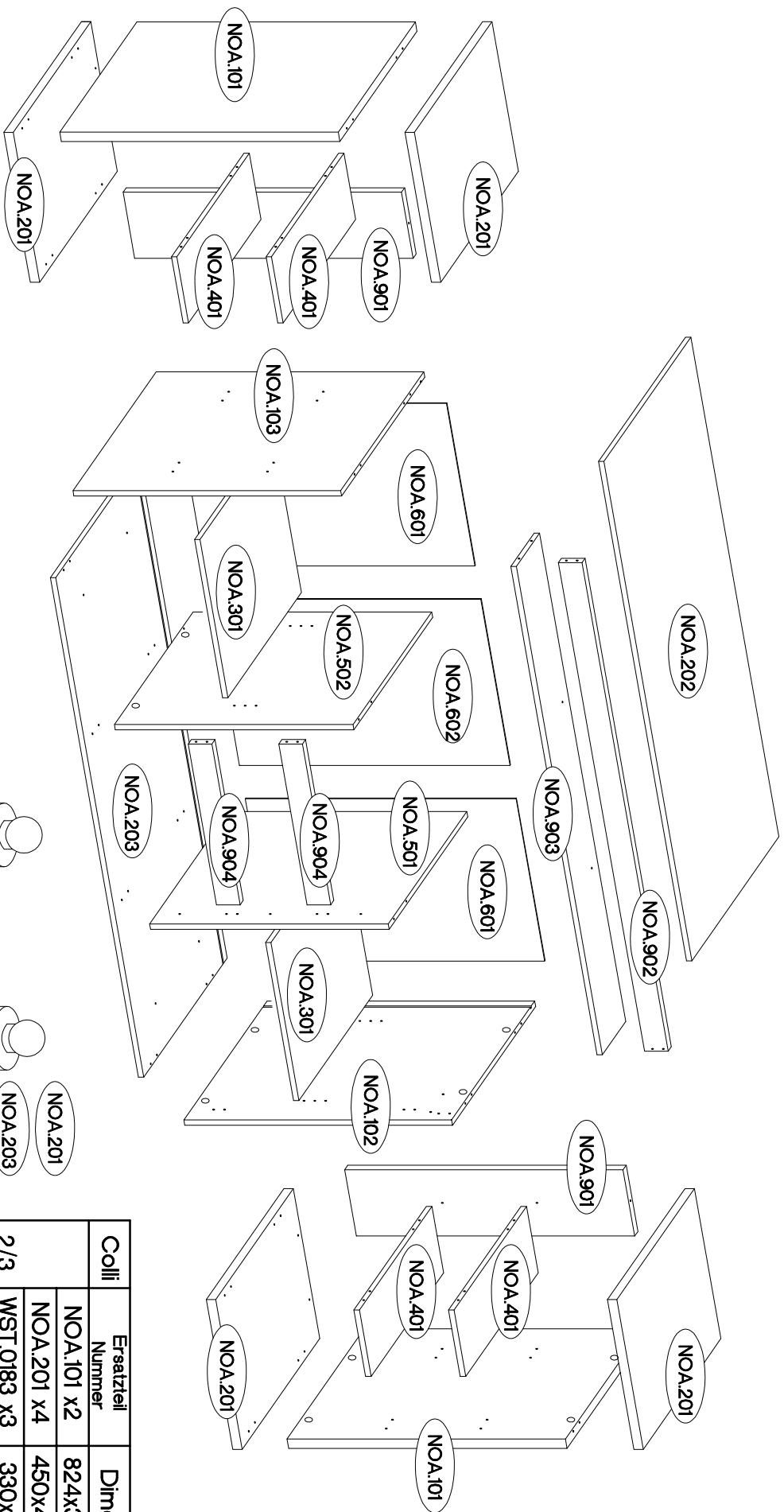

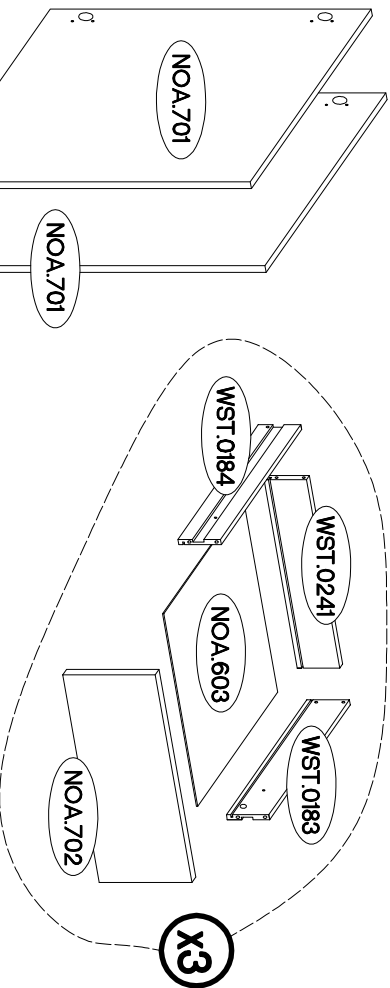

Coll.	Ersatzteil Nummer	Dimension
2/3	NOA.101 x2	824x398x28
	NOA.201 x4	450x400x28
	WST.0183 x3	330x100x12
2/3	WST.0184 x3	330x100x12
	WST.0241 x3	450x100x12



Coll.	Ersatzteil Nummer	Dimension
1/3	NOA.501	706x406x16
	NOA.502	706x406x16
	NOA.601 x2	801x488x2,5
	NOA.602	801x499x2,5
	NOA.701 x2	755x496x16
	NOA.702 x3	218x496x16
	NOA.901 x2	824x199x16
NOA.904 x2	483x70x16	

Coll.	Ersatzteil Nummer	Dimension
3/3	NOA.102	792x429x16
	NOA.103	792x429x16
	NOA.202	1500x448x16
	NOA.203	1500x430x16
	NOA.301 x2	475x380x16
	NOA.401 x4	199x374x16
	NOA.603 x3	460x327x2,5
NOA.902	1467x70x16	
NOA.903	1467x120x16	



1

±12/10mm  C5 6	±8x30mm  A 12	 O1 1
---	--	---

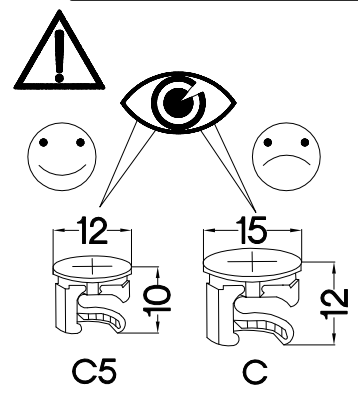
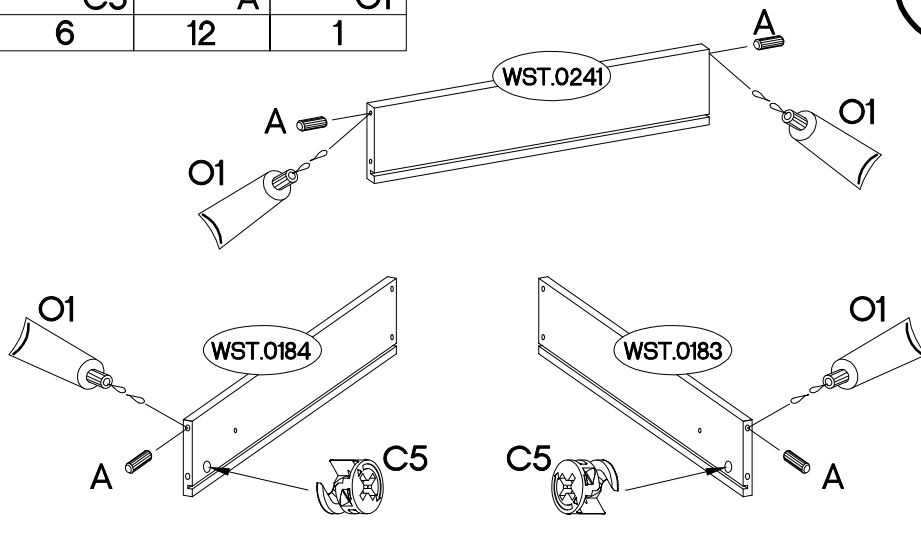
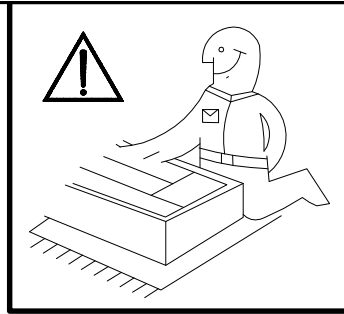
x3

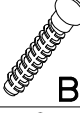

2

±6x42mm  B2 6	 O1 1
---	--

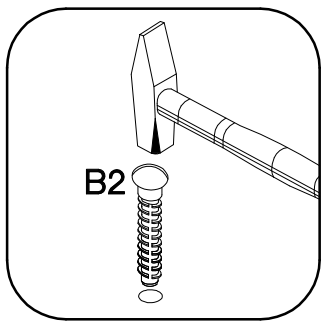
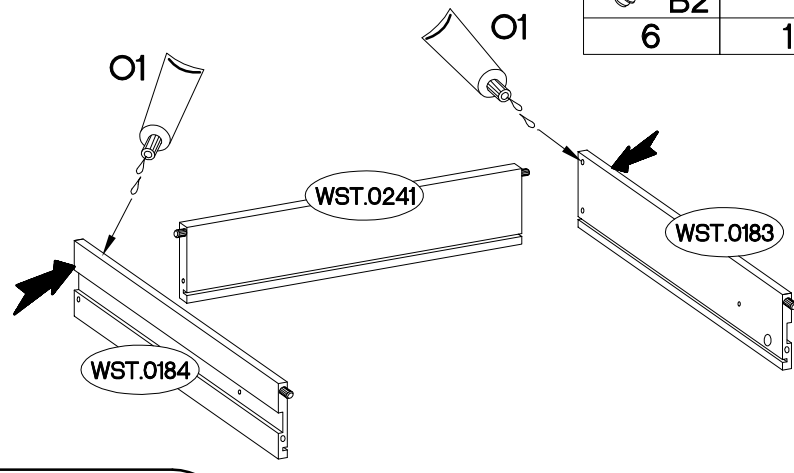
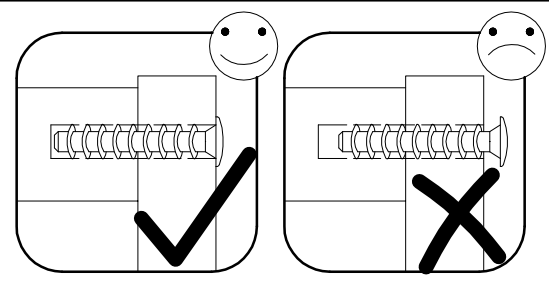

x3

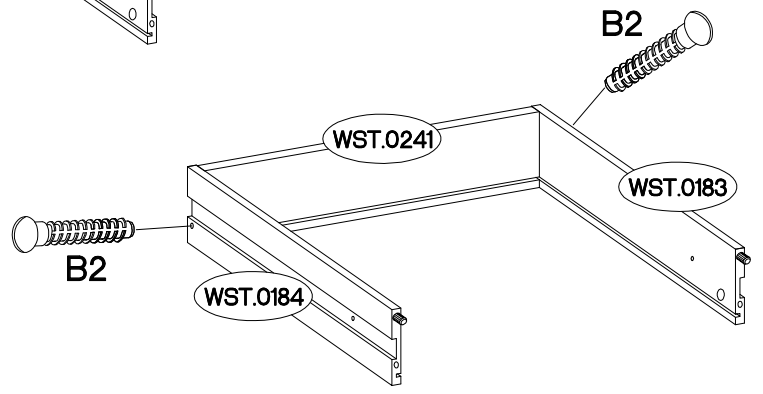

3

L=20mm  D2 6
--

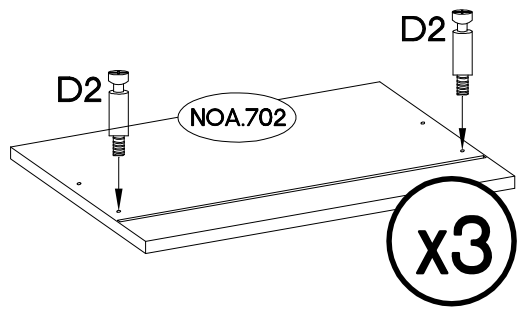
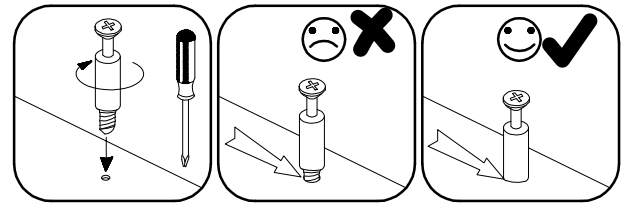

x3

4

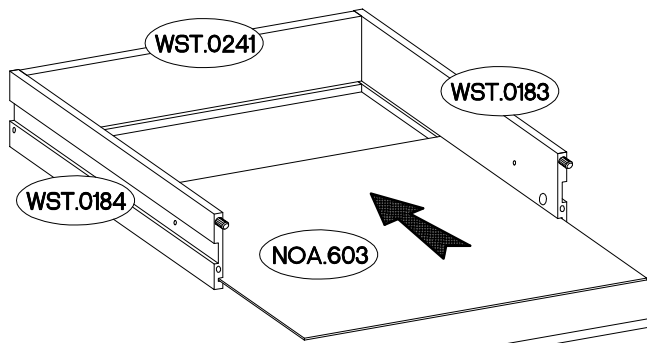

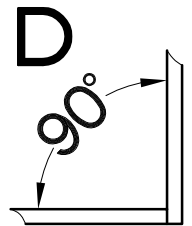
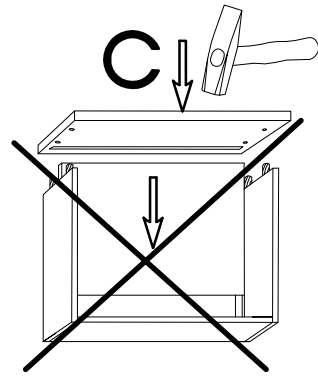
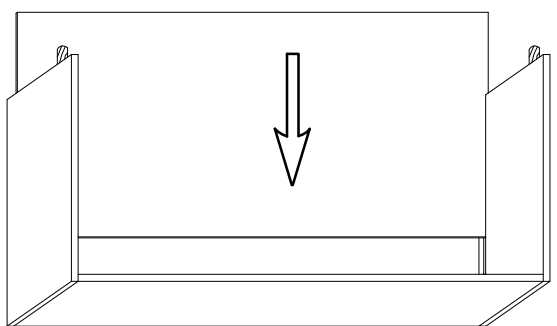
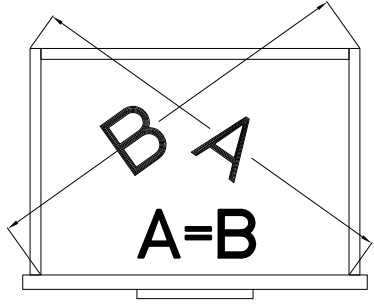
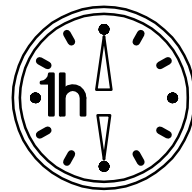
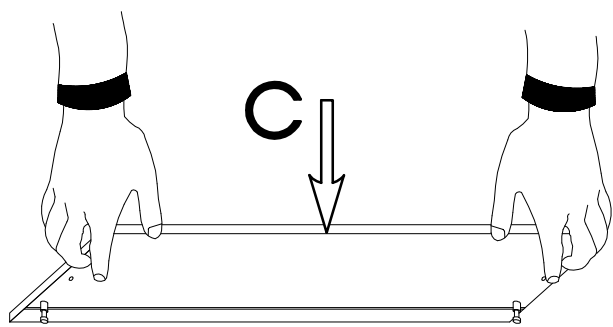
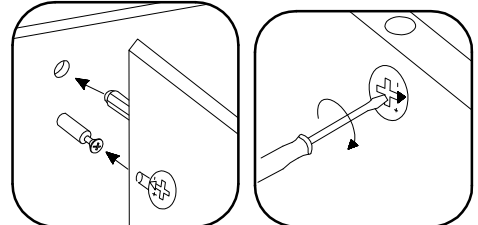
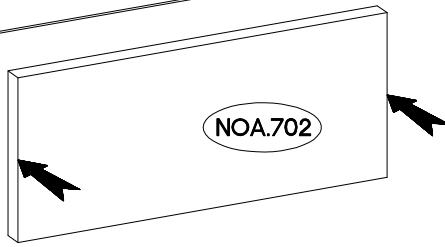
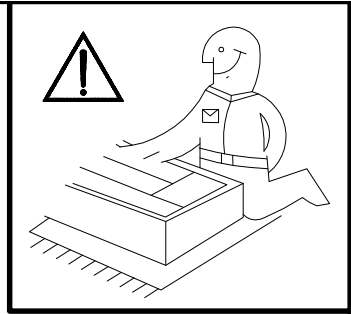

x3



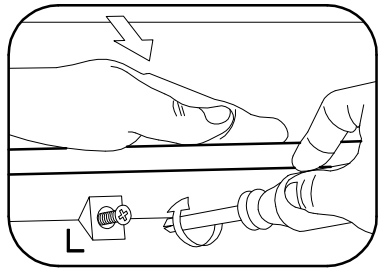
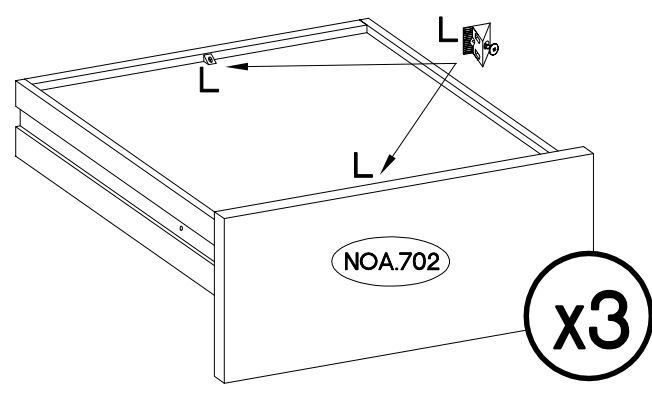
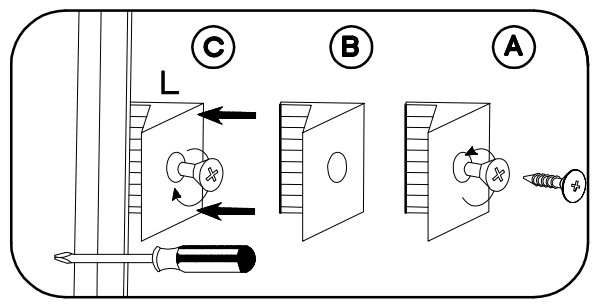
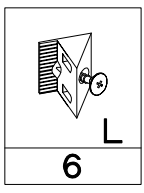



5

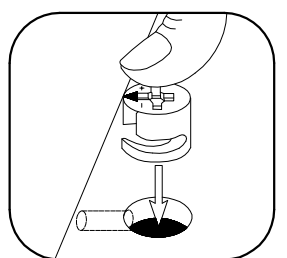
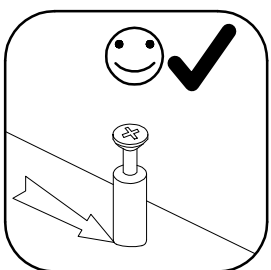
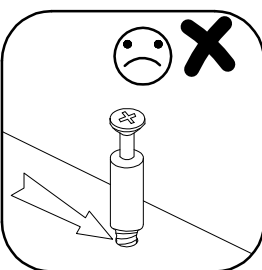
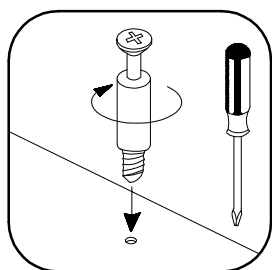
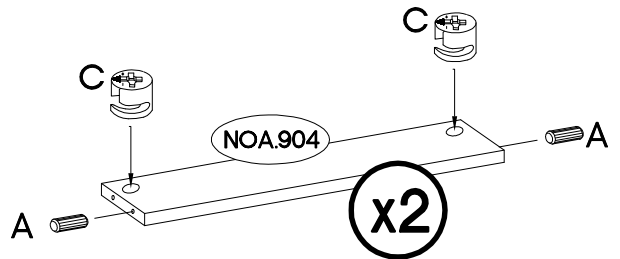
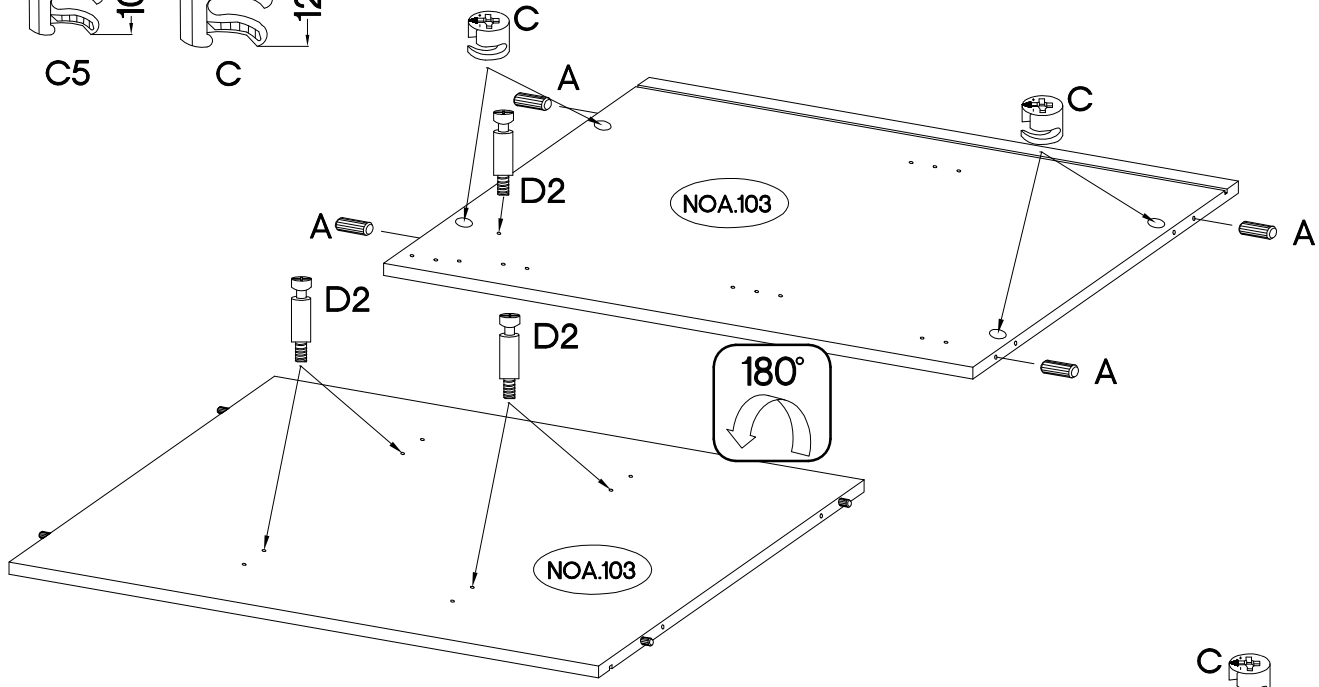
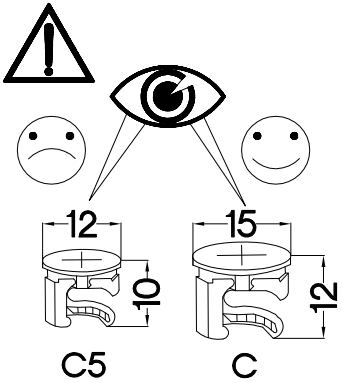
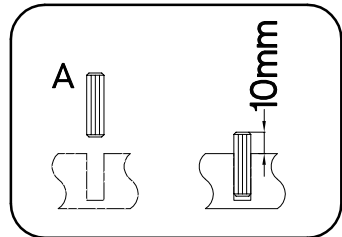
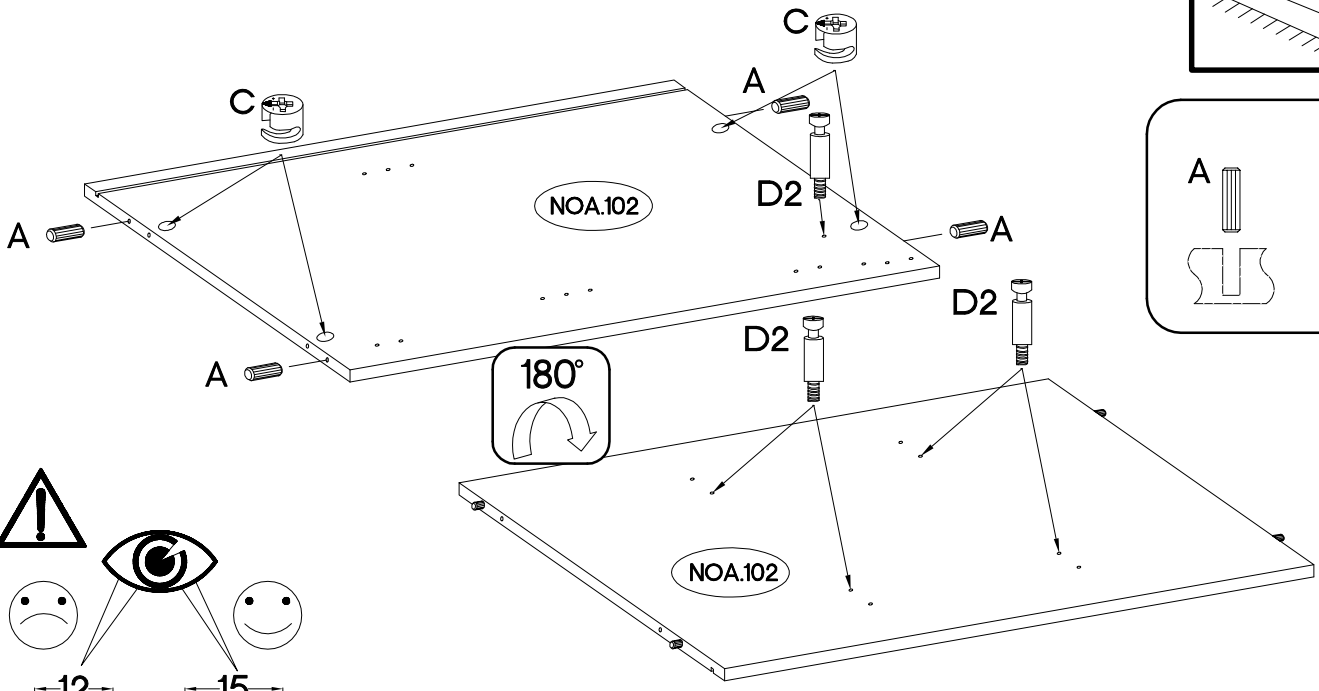
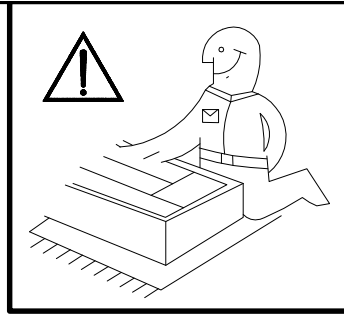



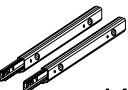

 <p>±8x30mm A</p>	 <p>L=20mm D2</p>	 <p>±15/12mm C</p>
12	10	12

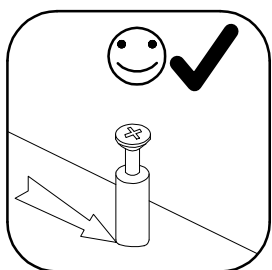
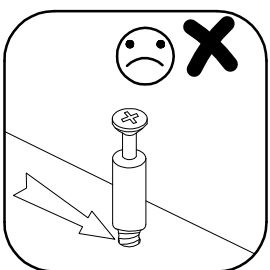
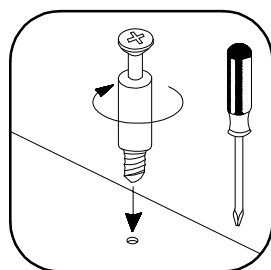
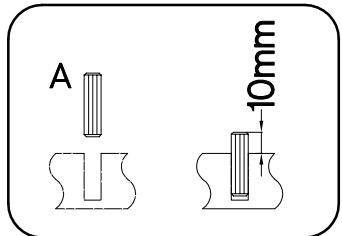
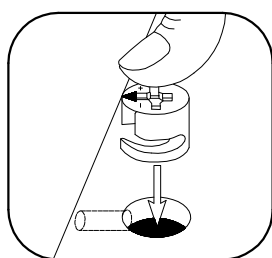
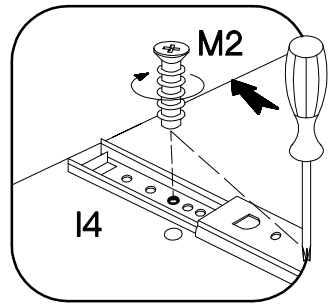
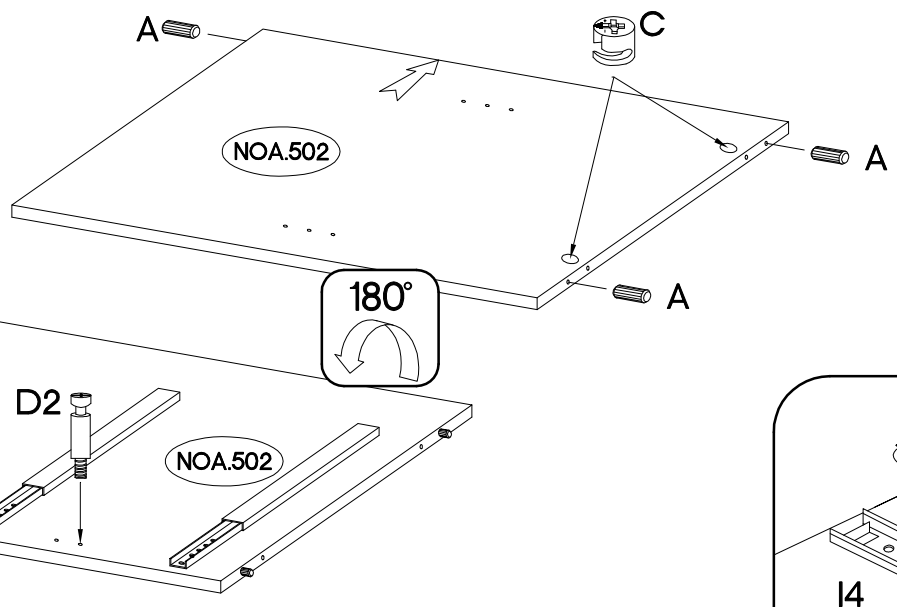
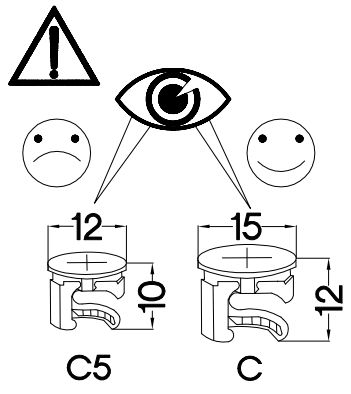
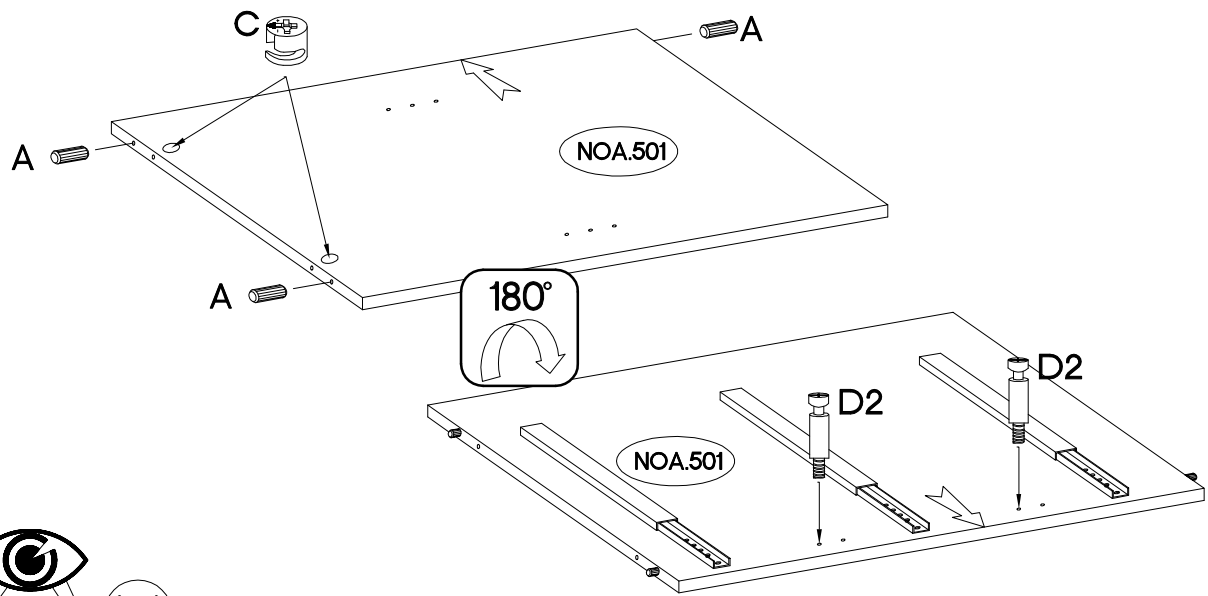
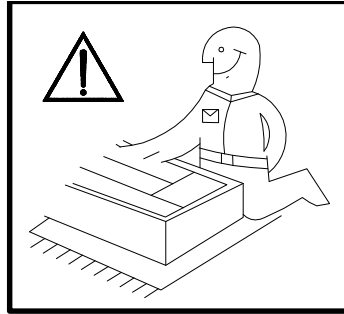

 <p>8x30mm A</p>	 <p>L=20mm D2</p>	 <p>15/12mm C</p>	 <p>27/310mm I4</p>	 <p>6,3x13mm M2</p>
6	4	4	3	12



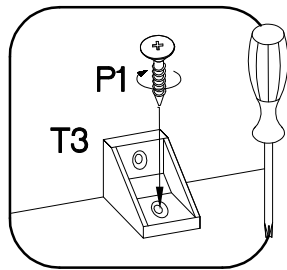
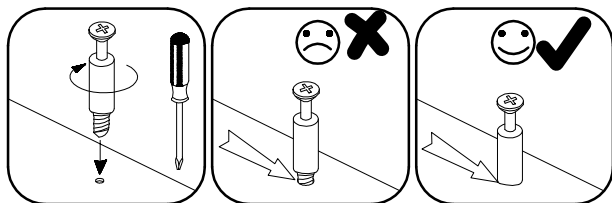
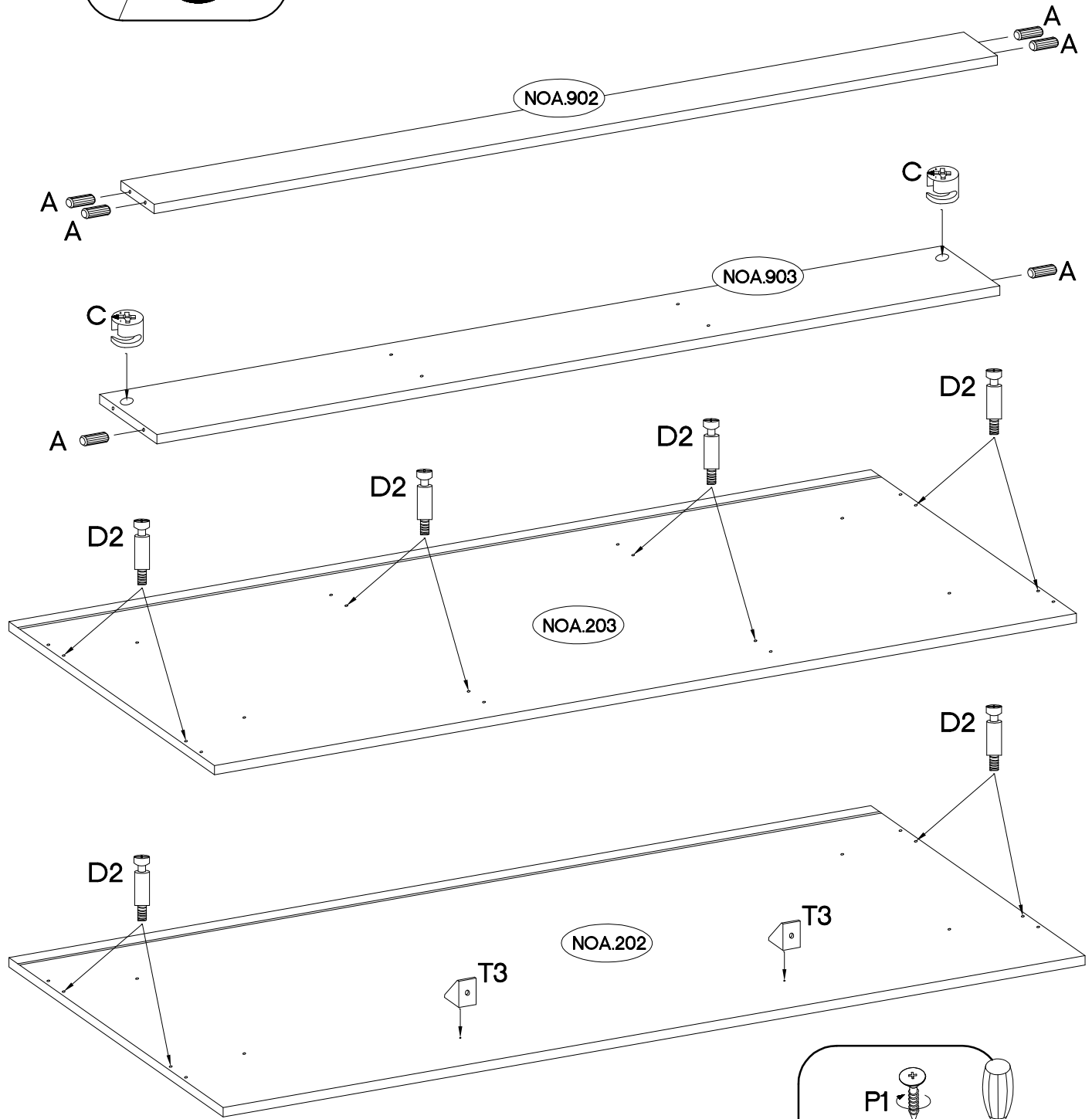
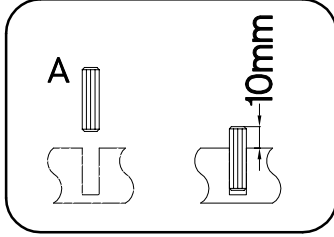
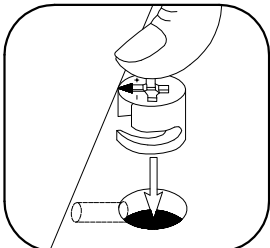
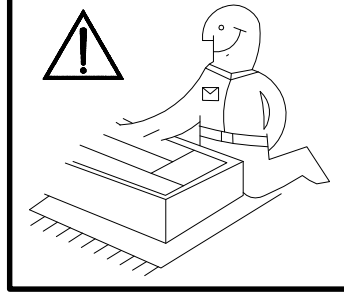

 A 6	 D2 12	 C 2	 T3 2	 P1 2
---	---	---	--	--

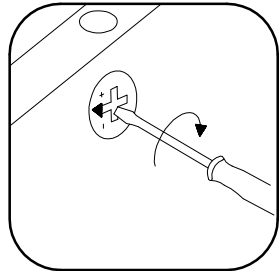
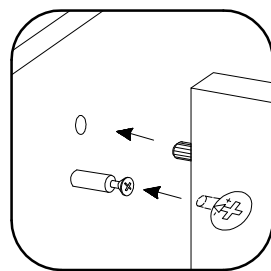
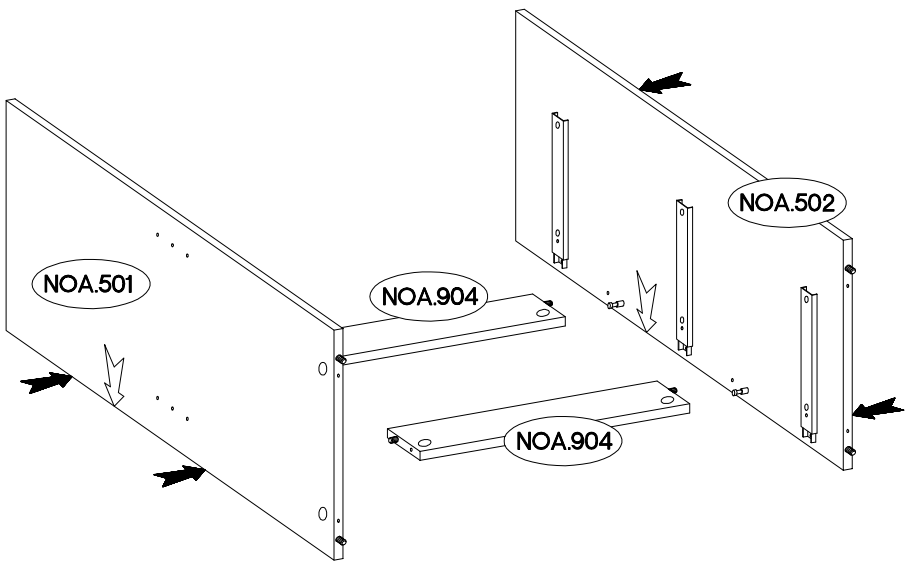
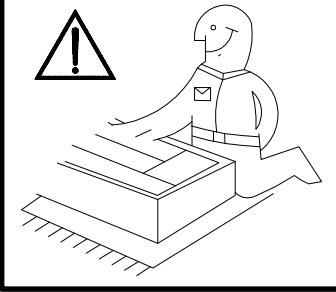

9

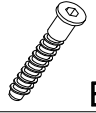

10

6,4 x 50mm	
	
B	O
2	1

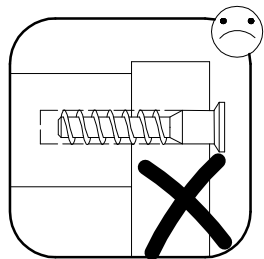
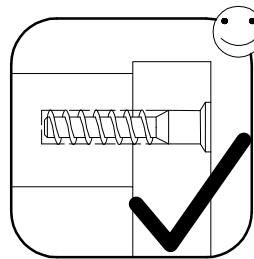
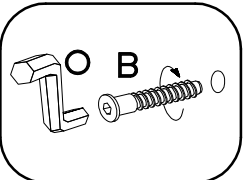
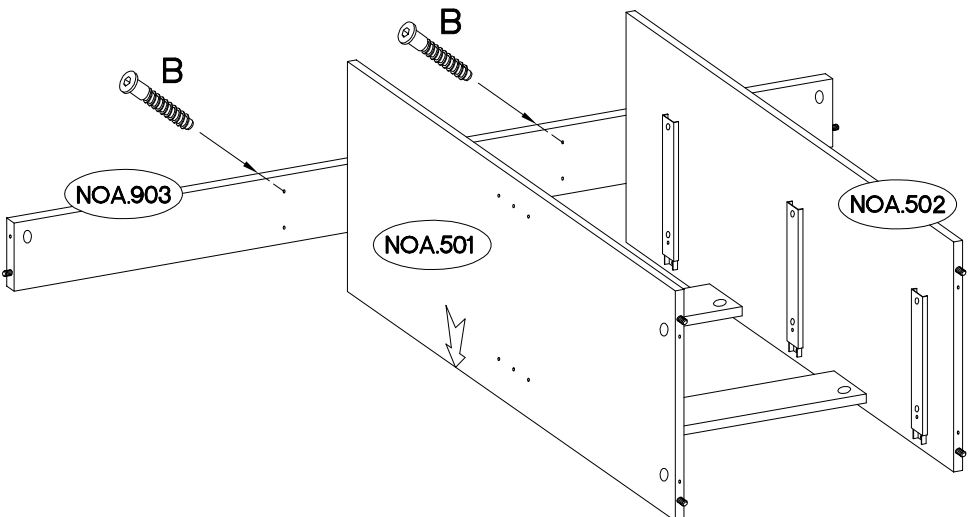

11

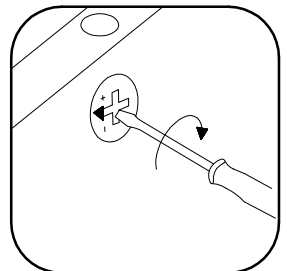
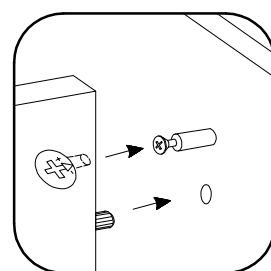
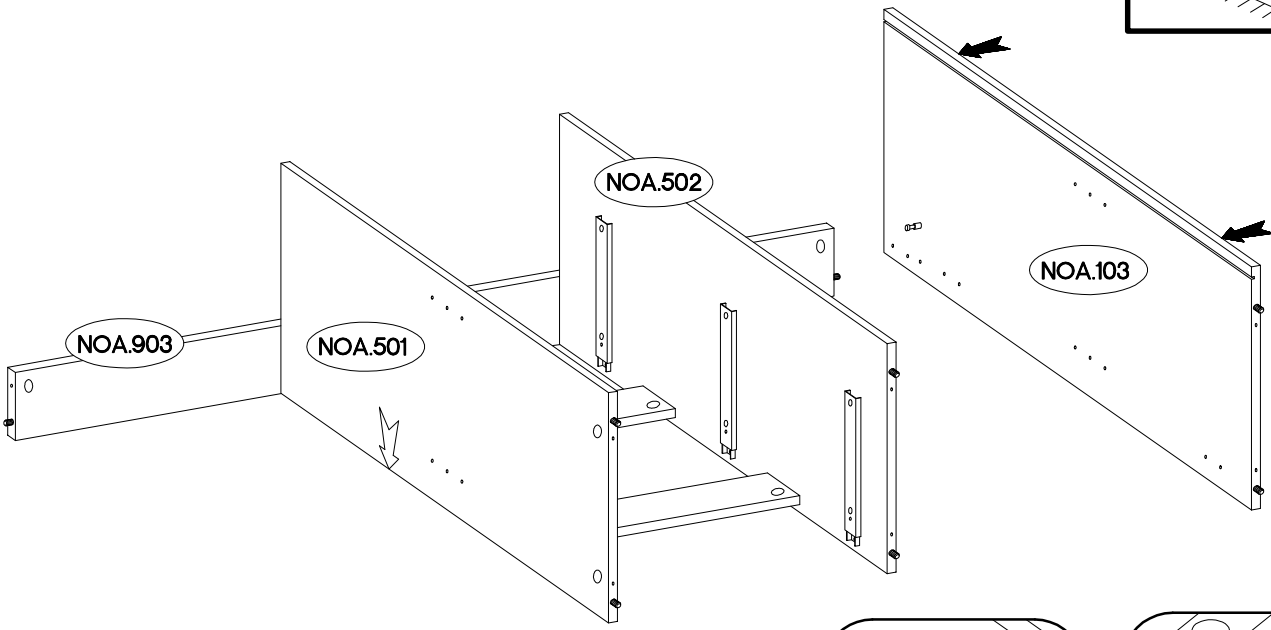
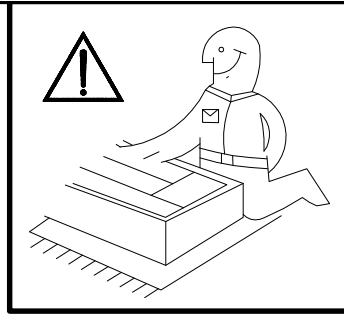

12

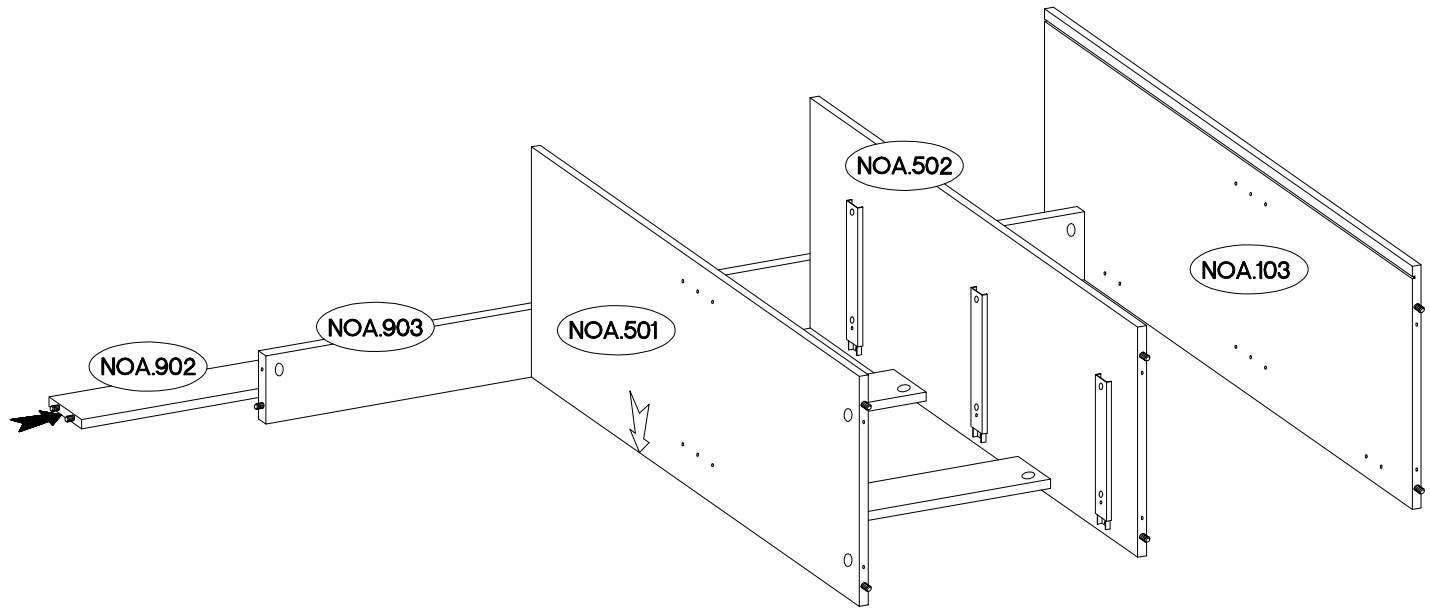

13

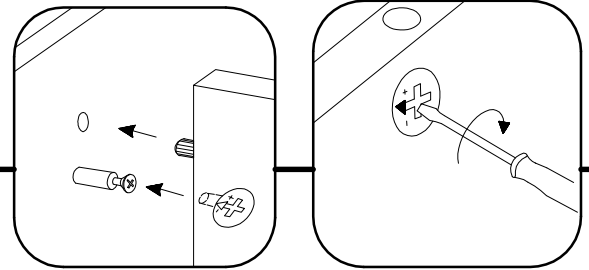
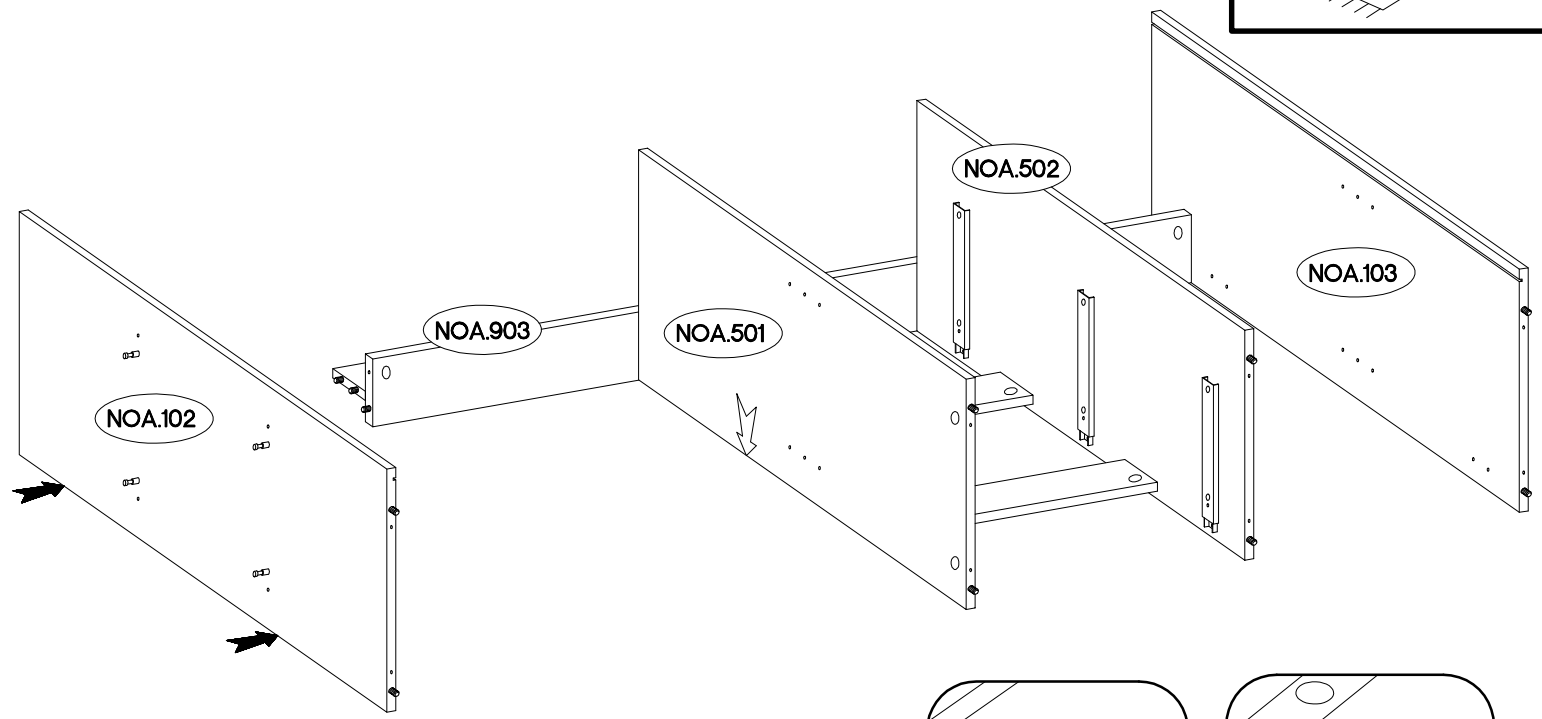
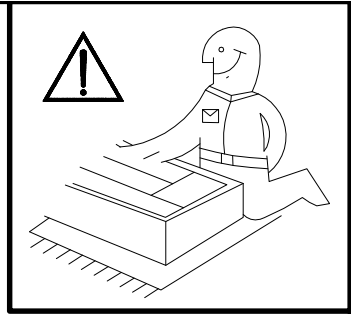

14

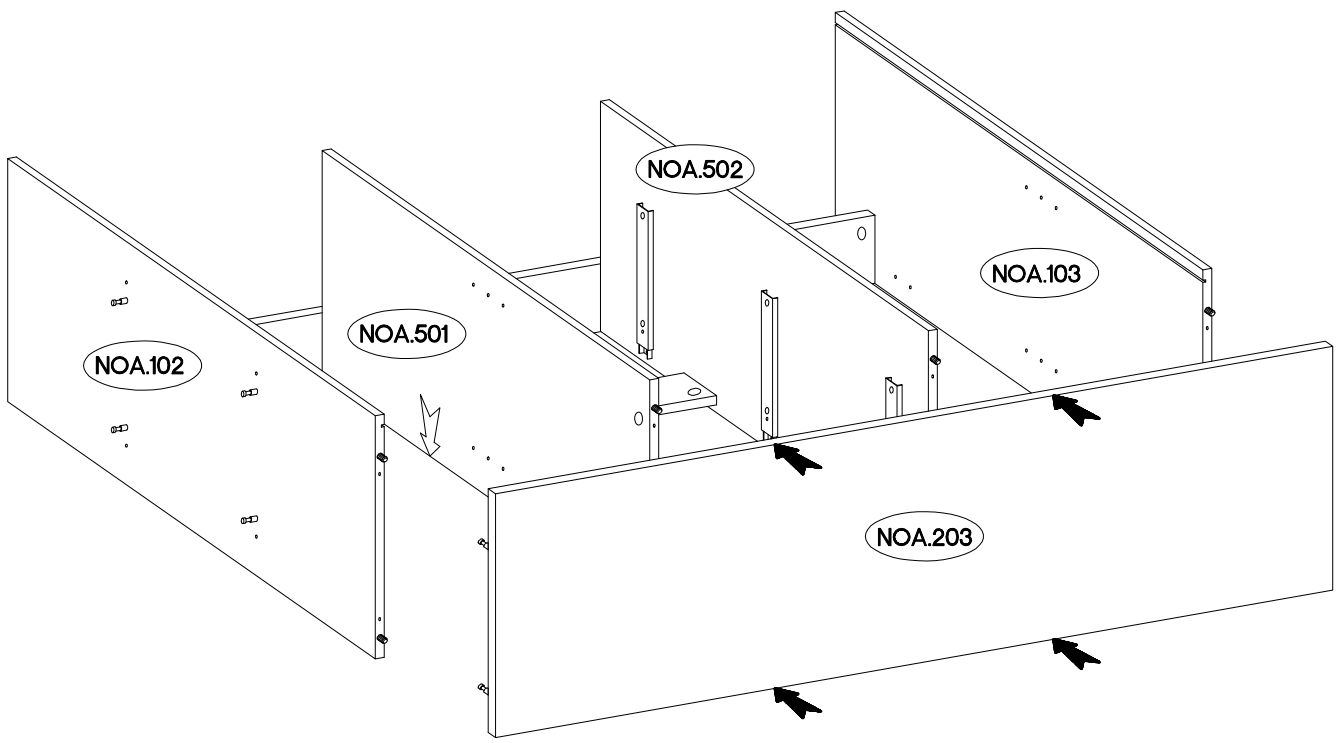

15

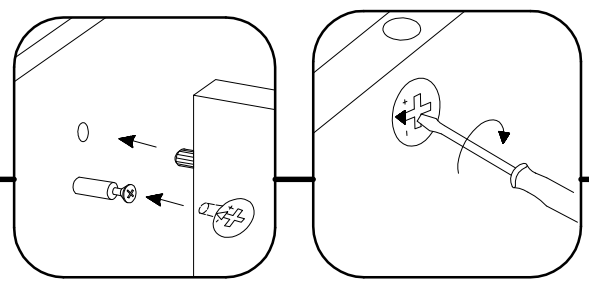
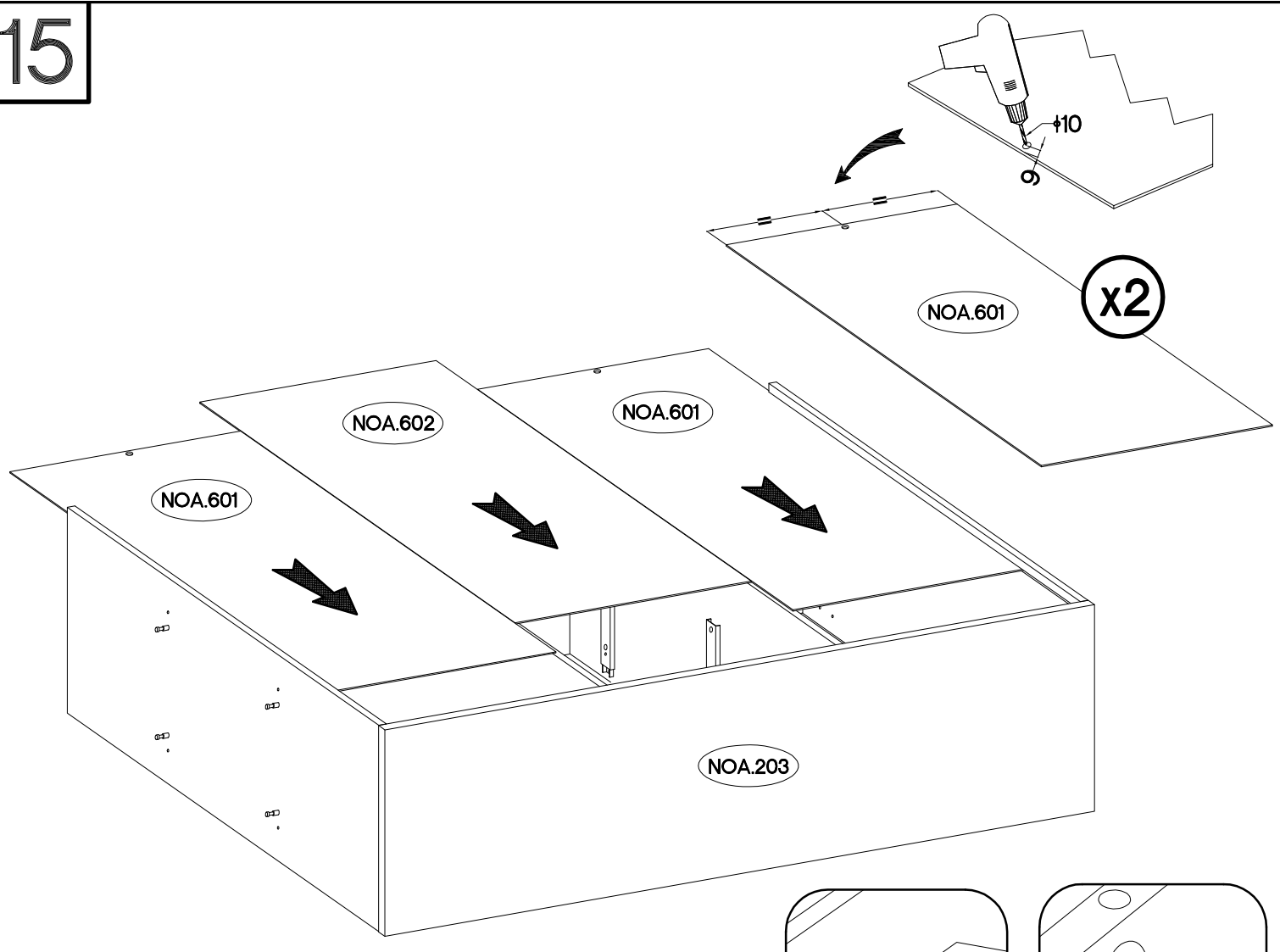

16

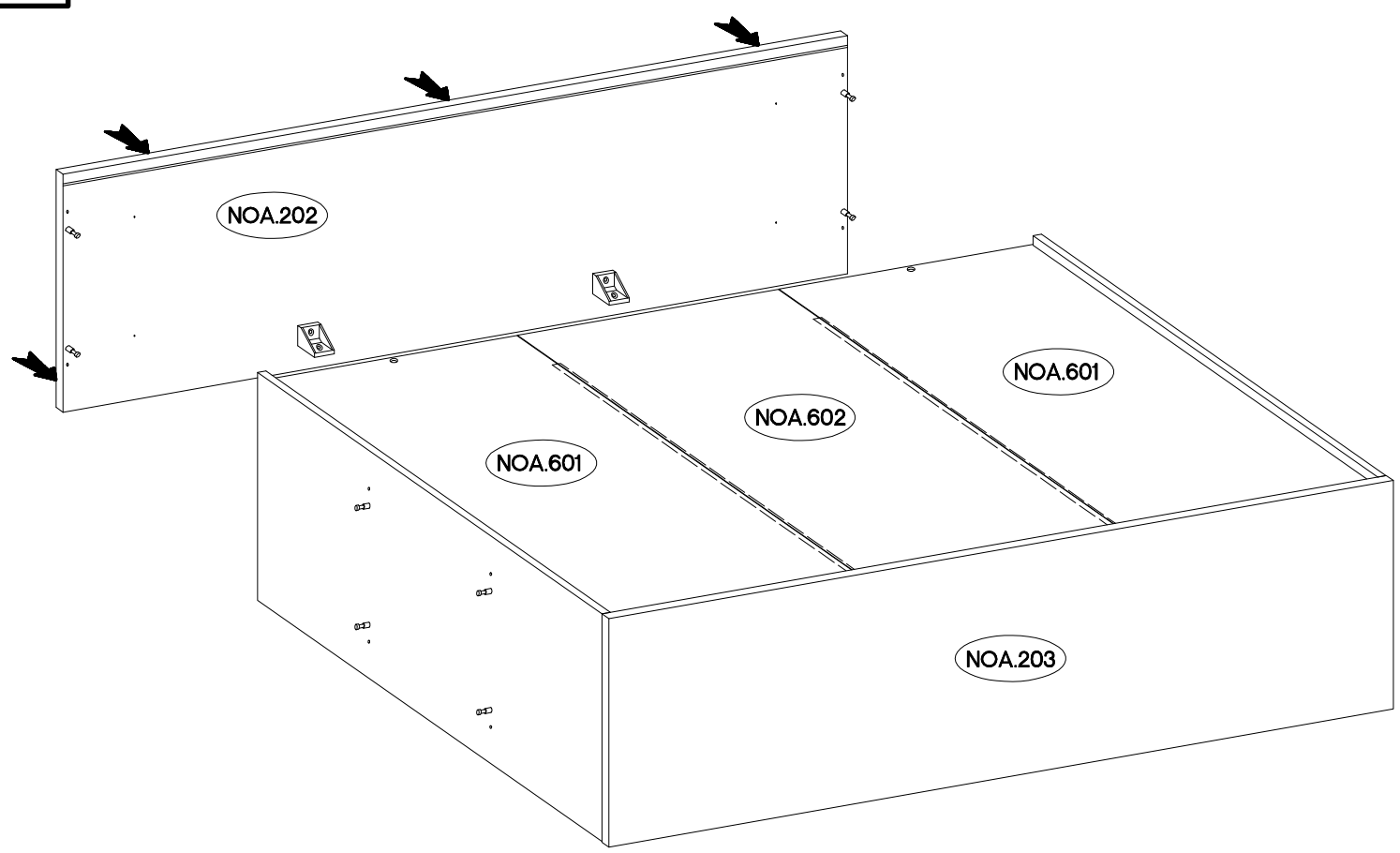

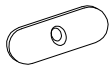
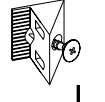

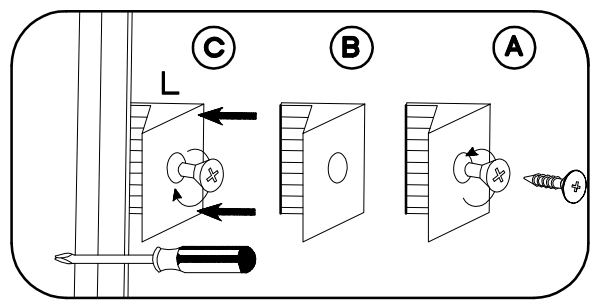
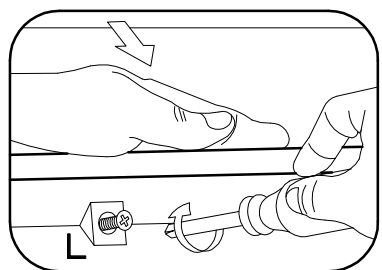
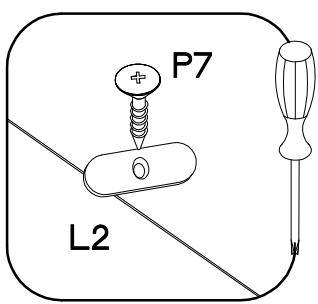
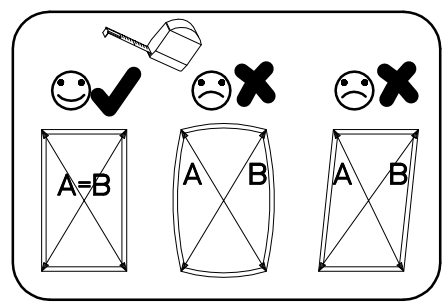
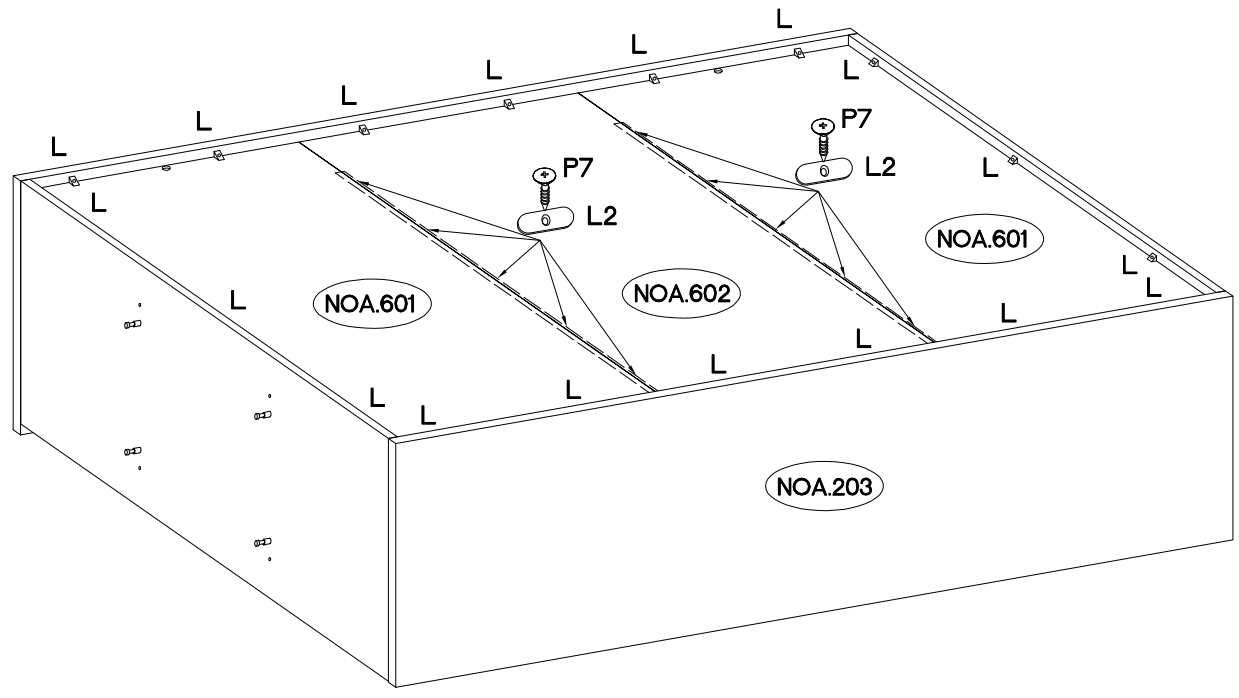
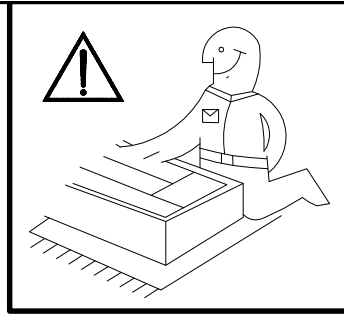
+3.0x20mm  P7 10	 L2 10	 L 18
---	--	---



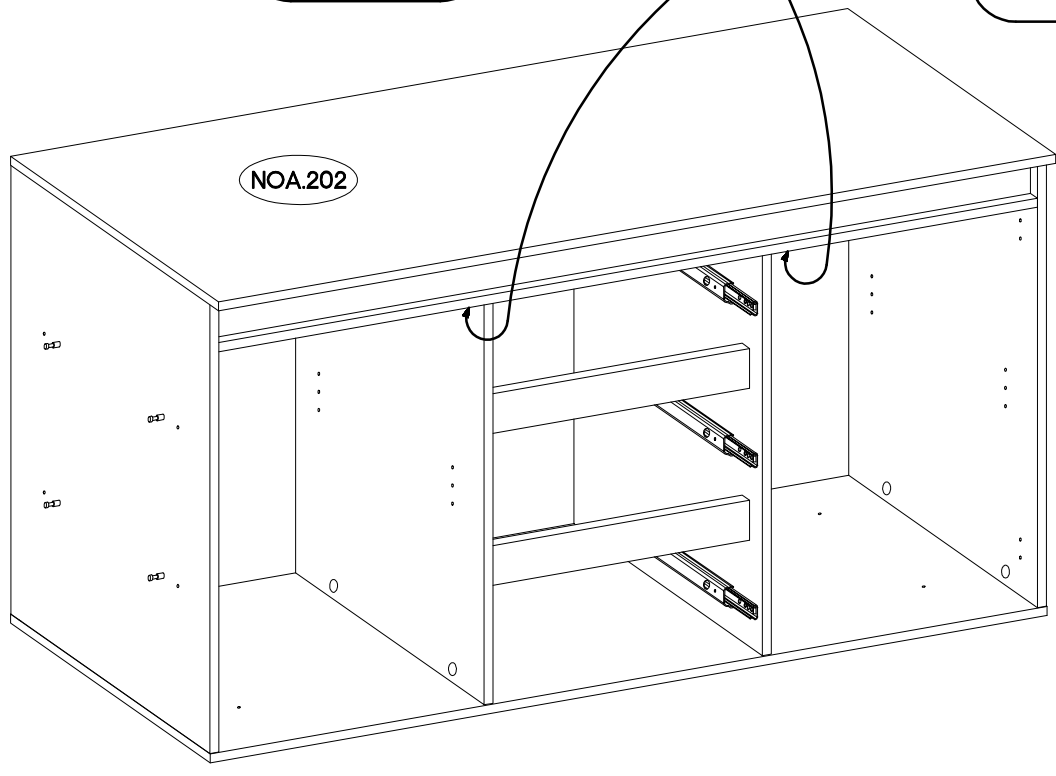
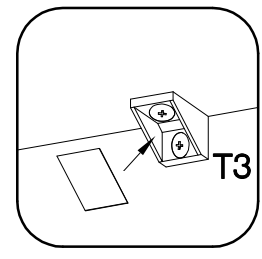
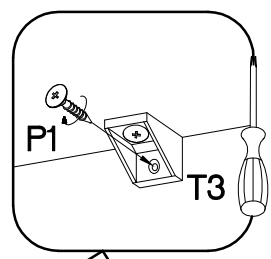
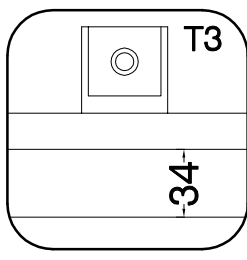

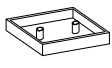
±4.0x16mm

P1
2

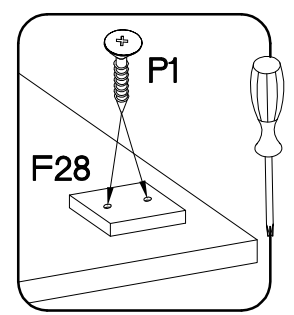
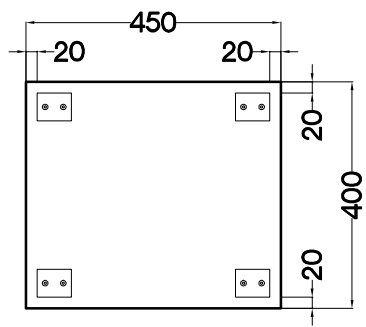
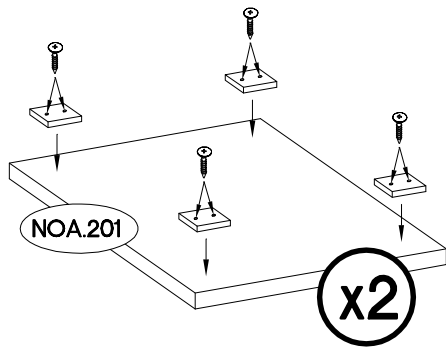

60x49x10	±4.0x16mm
	
F28	P1
8	16

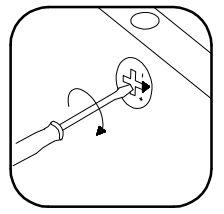
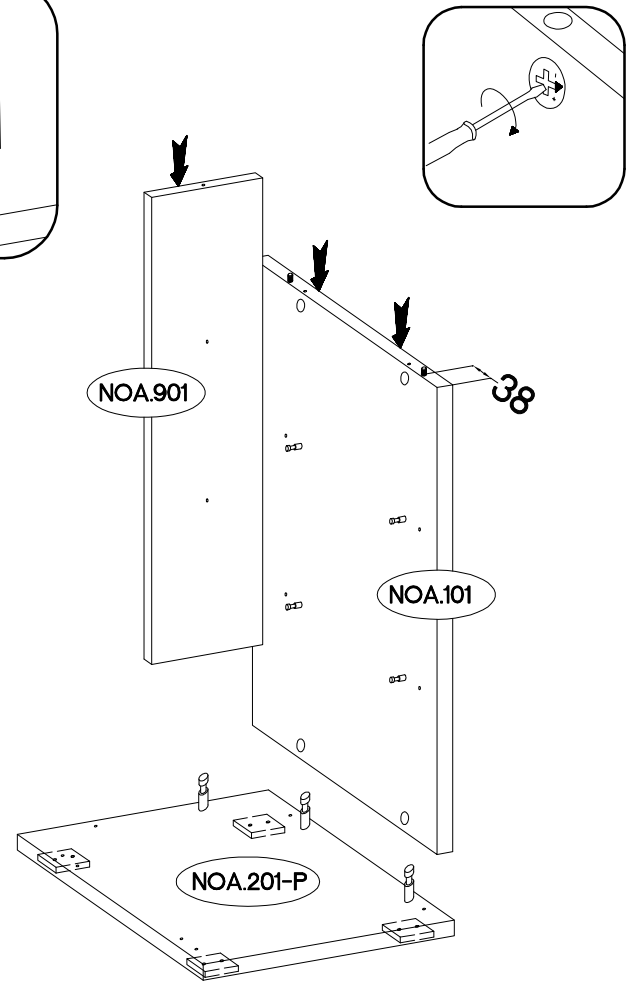
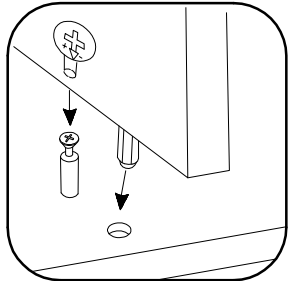
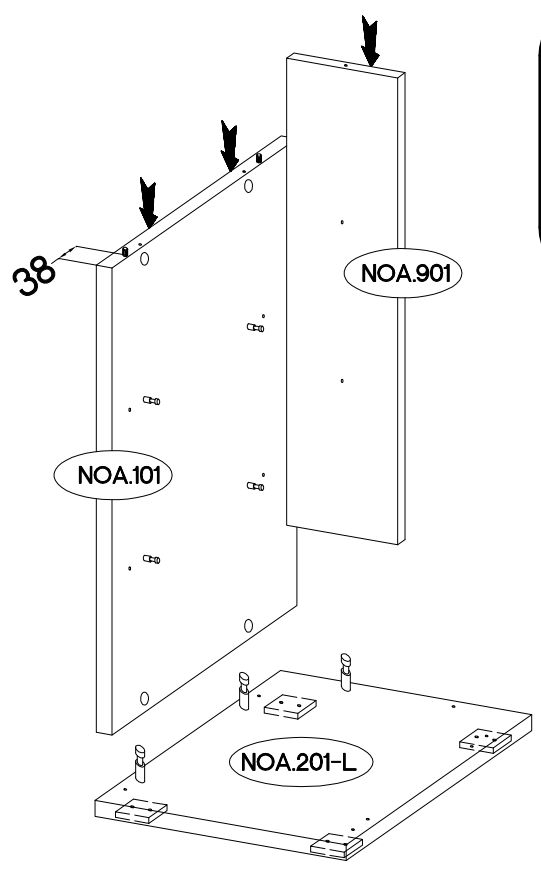
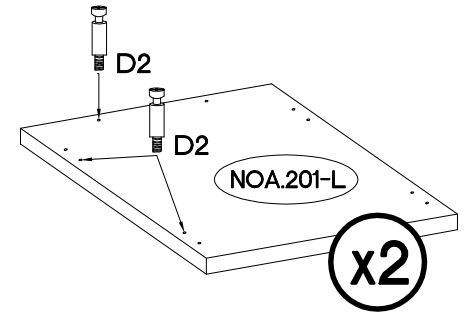
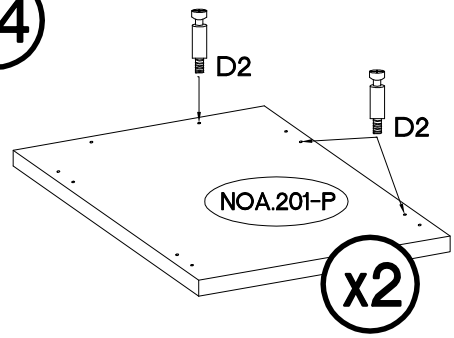
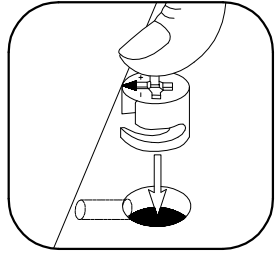
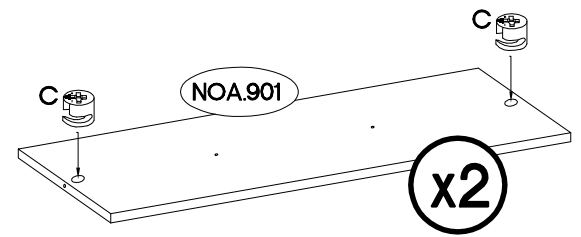
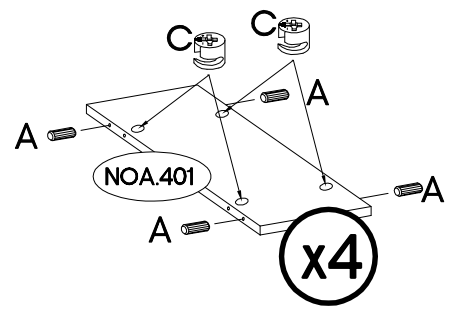
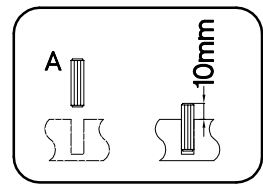
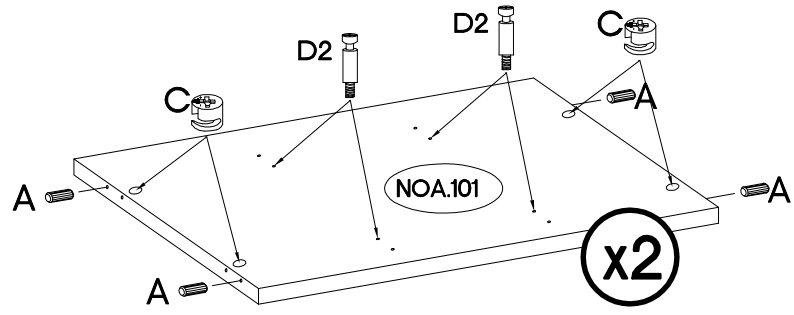
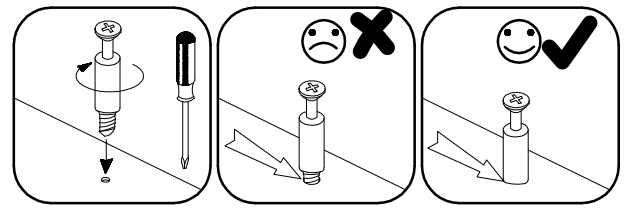

$\varnothing 8 \times 30 \text{mm}$  A 24	L=20mm  D2 20	$\varnothing 15/12 \text{mm}$  C 28
--	--	--



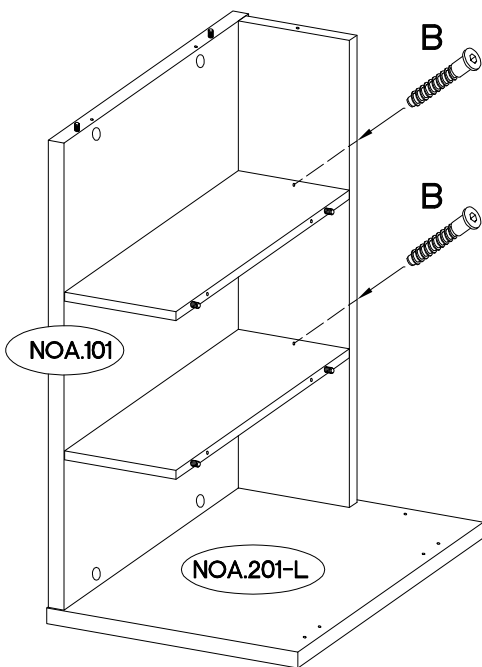
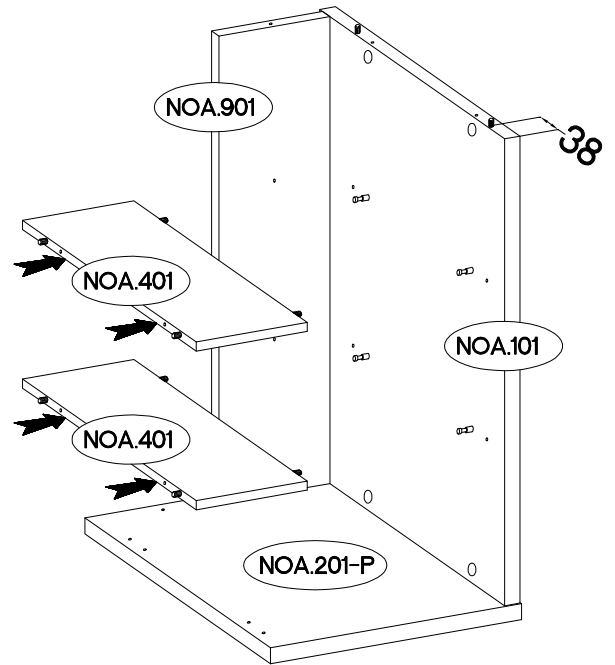
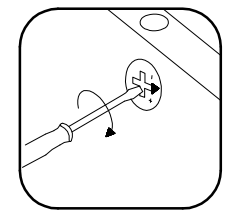
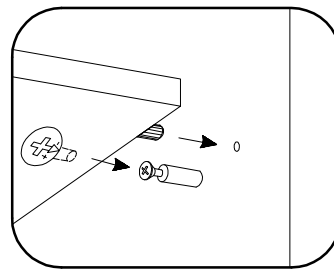
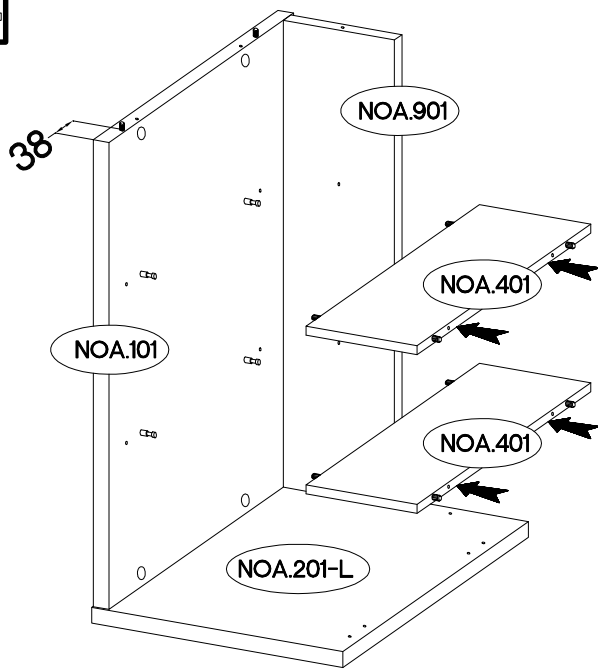

6,4 x 50mm		
4 B	1 O	4 E1

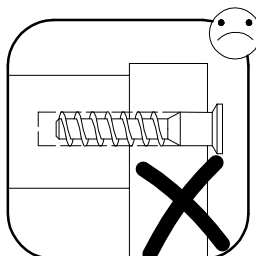
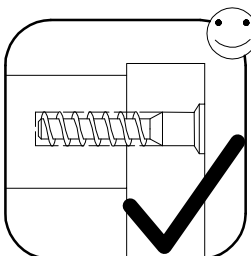
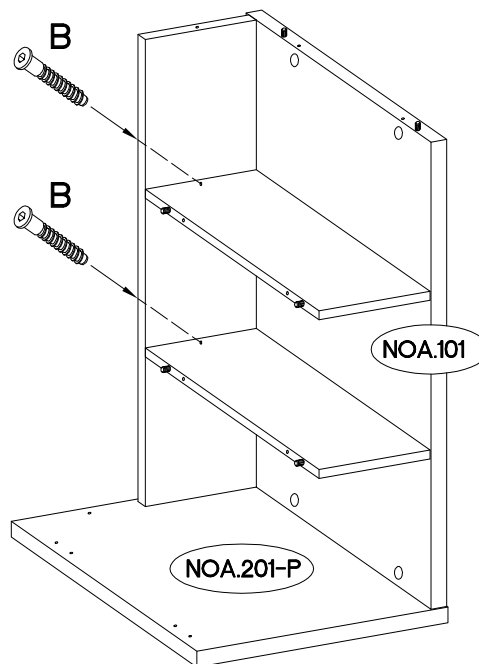
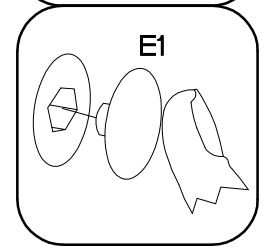
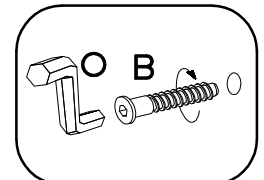

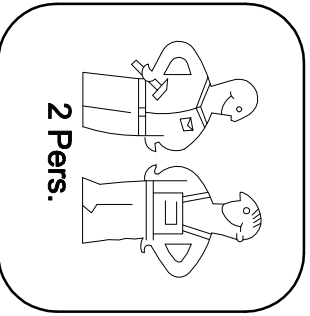
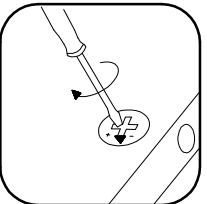
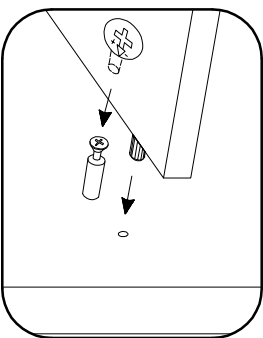
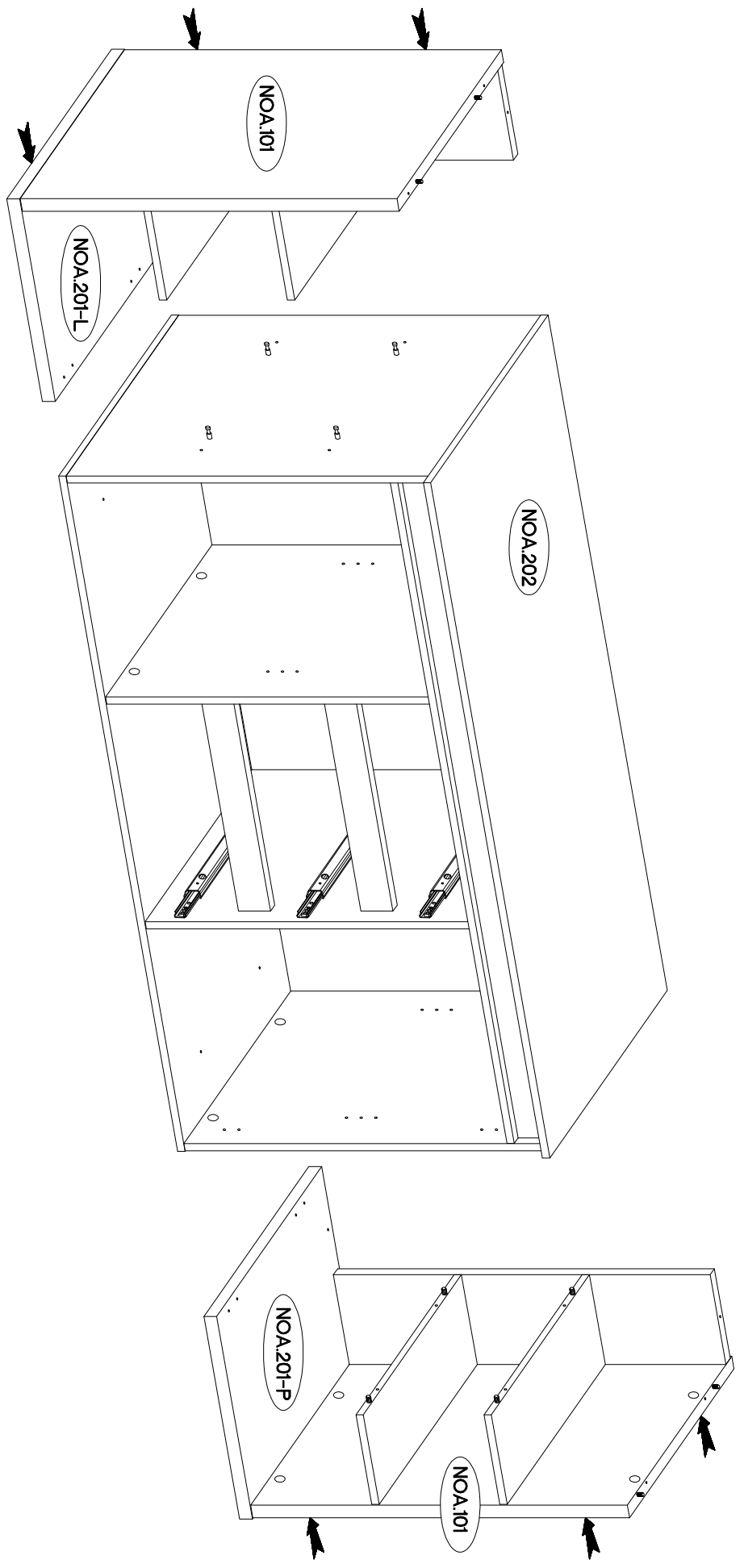



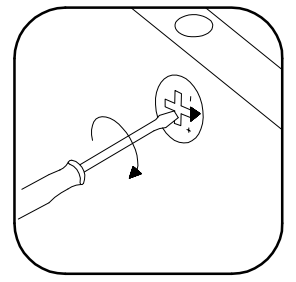
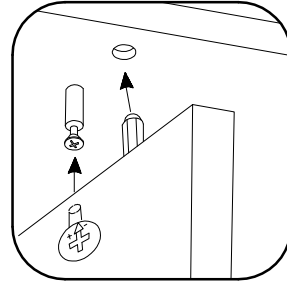
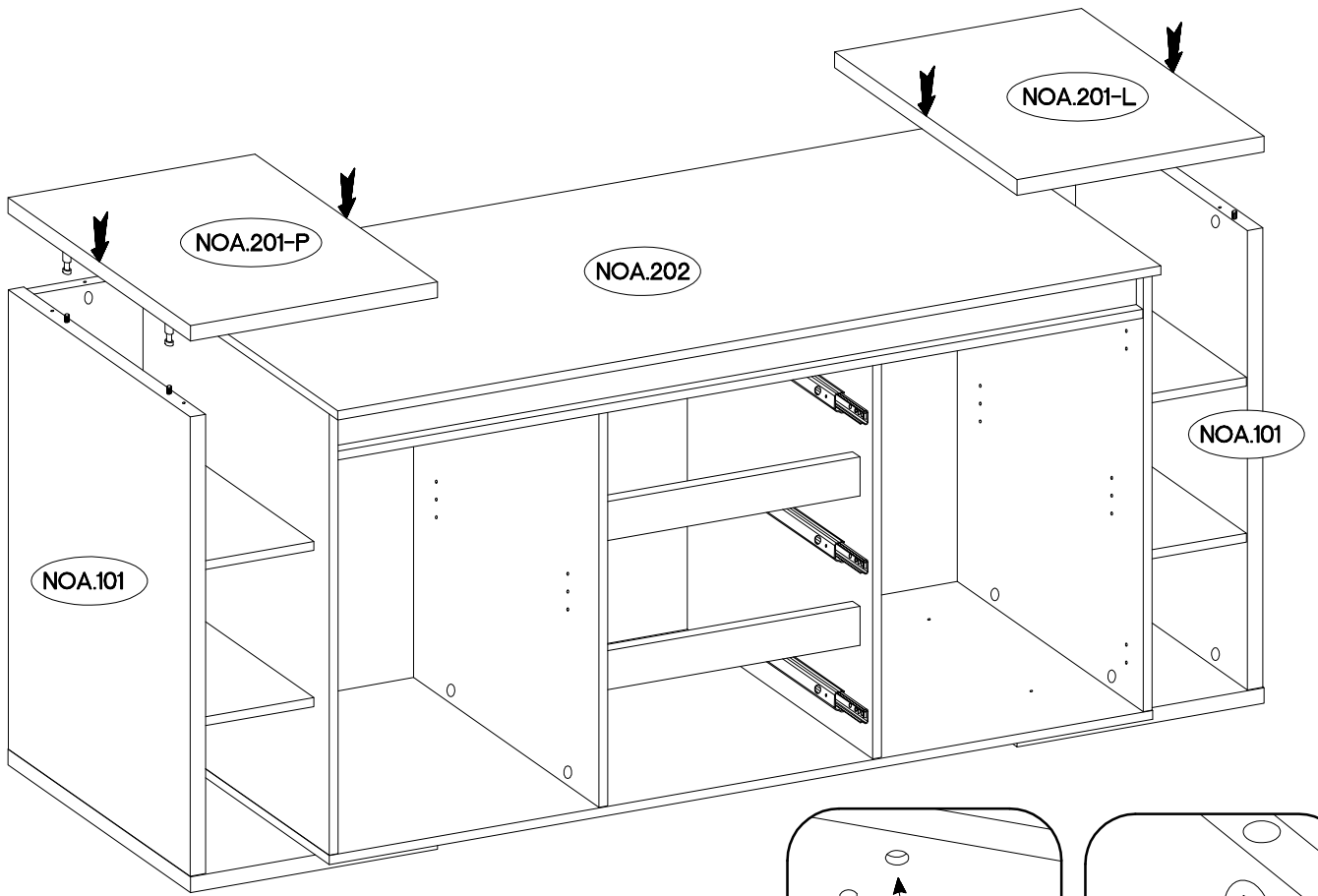

25

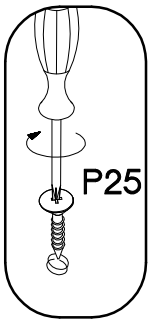
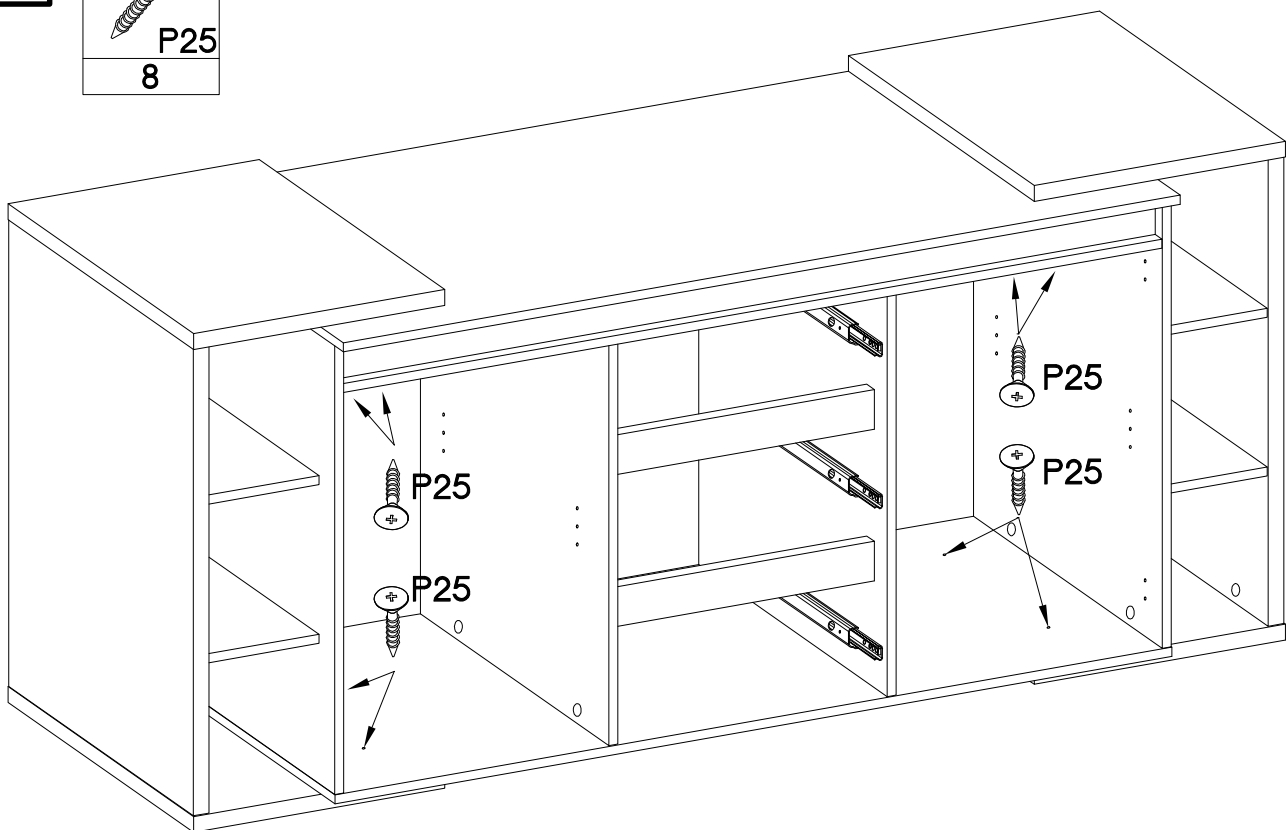

26

4x3.5x25mm
BLACK
P25
8



+10x50mm 		+3.5x13mm 
O7	L9	P5
2	2	2

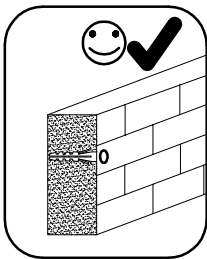
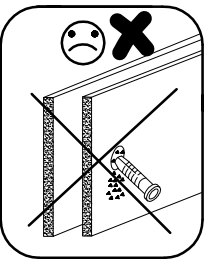
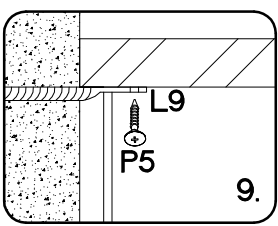
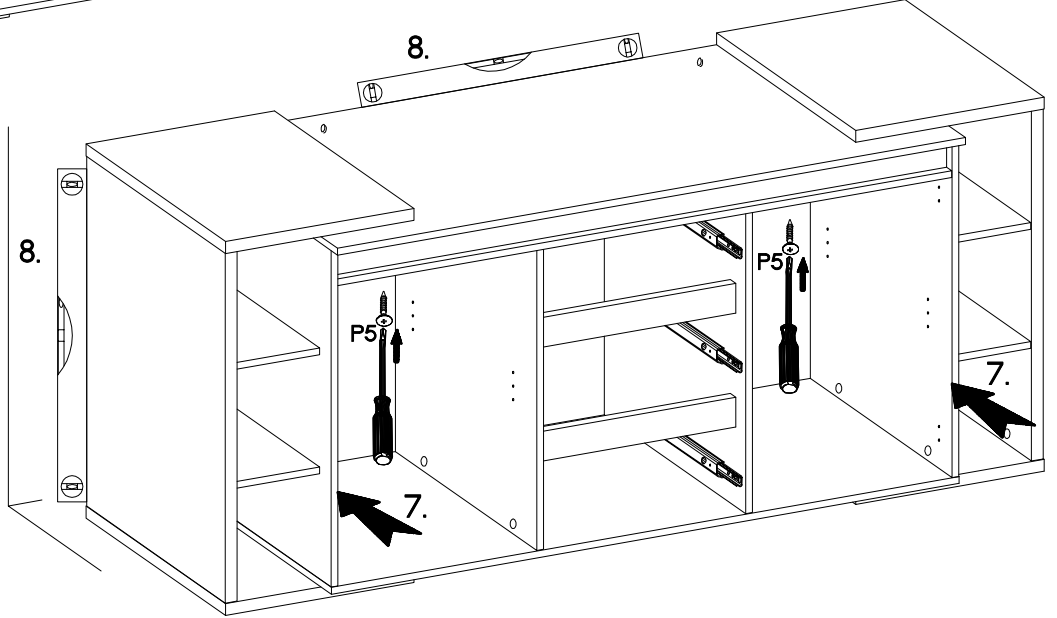
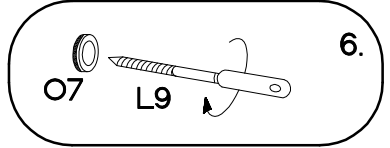
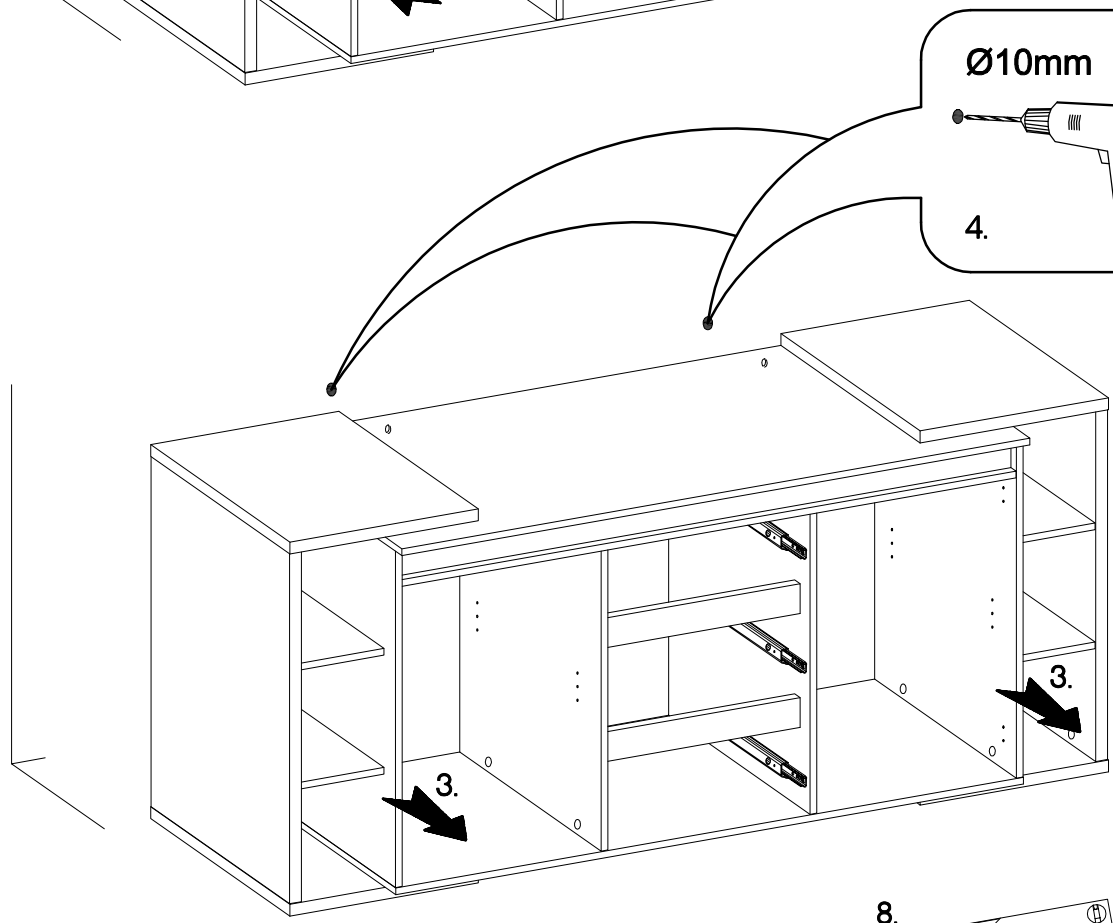
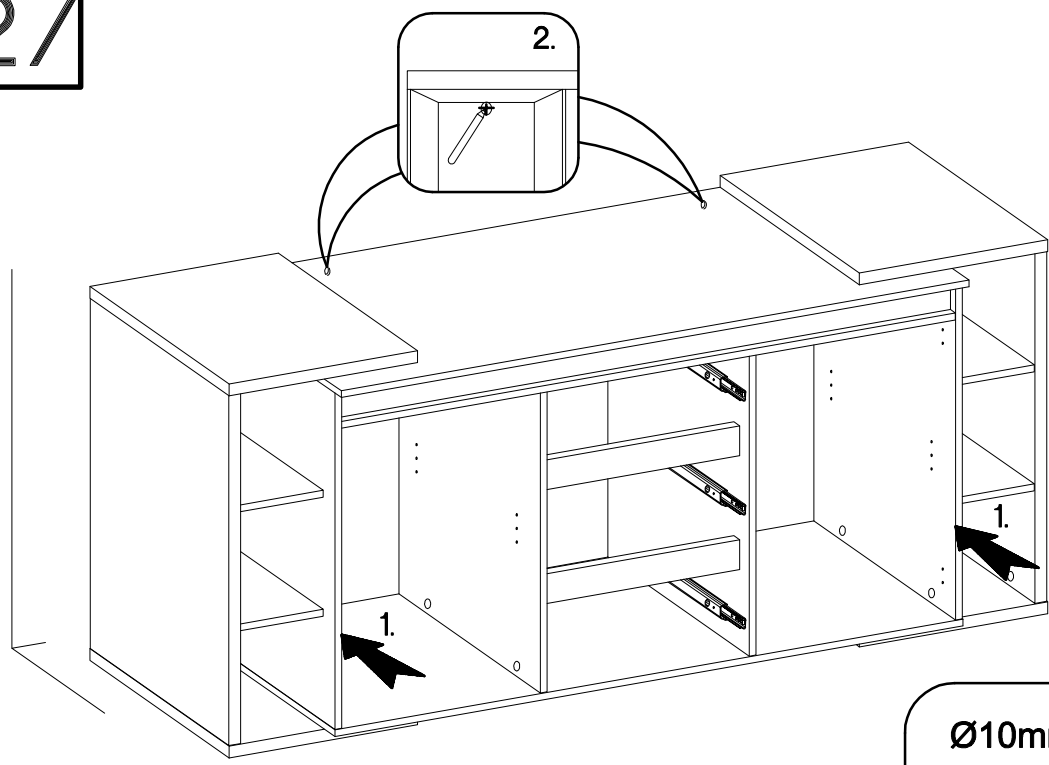

M4x9mm



U1

6

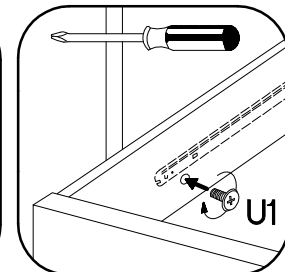
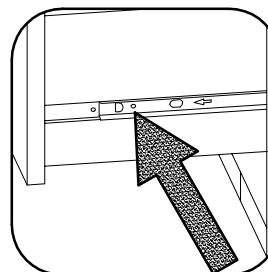
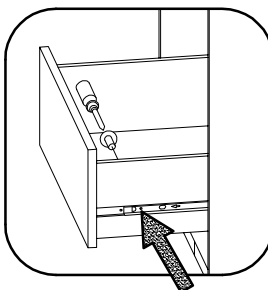
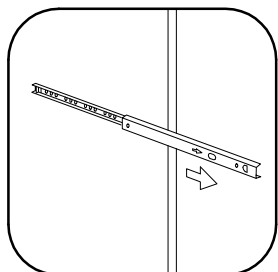
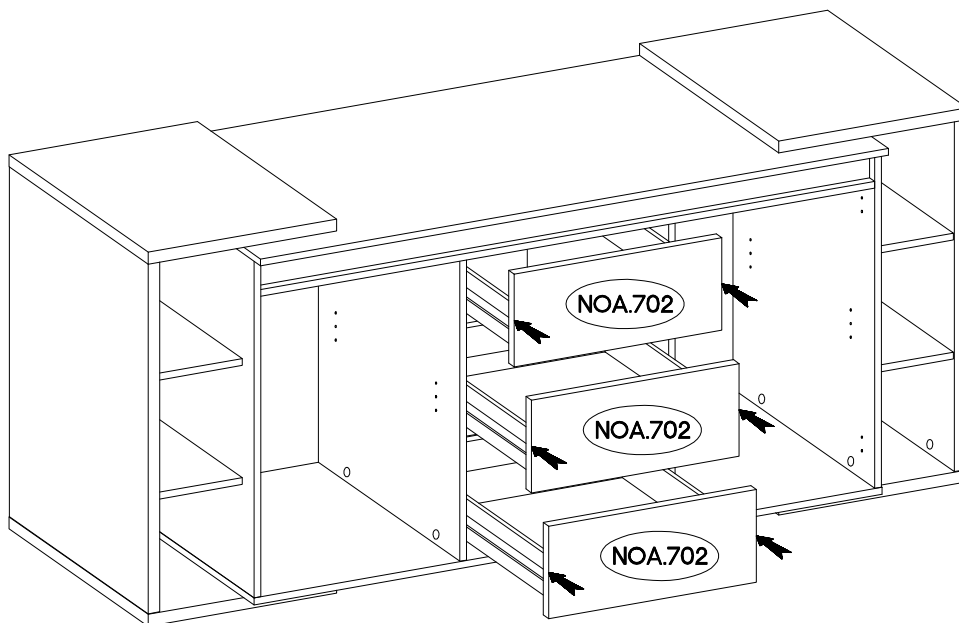

±5/16mm



J3

8



ant. E

14



szar. E

28

±14



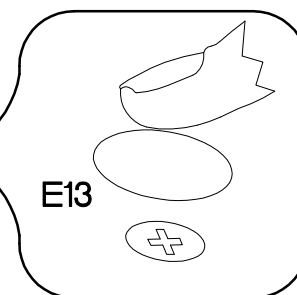
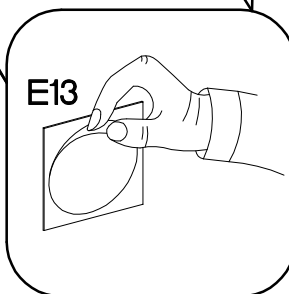
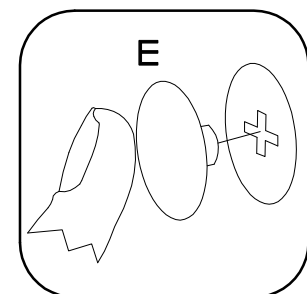
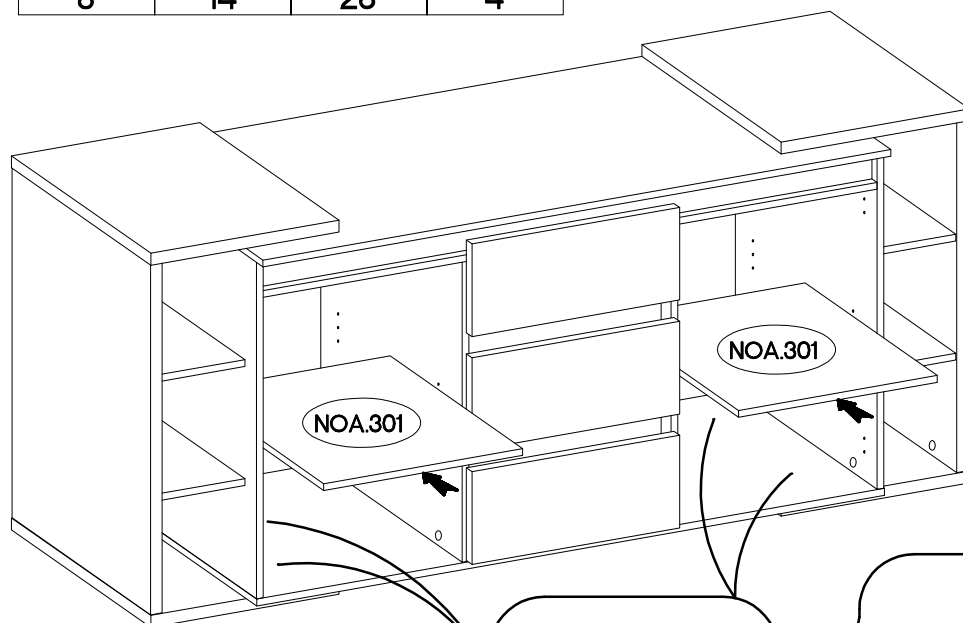
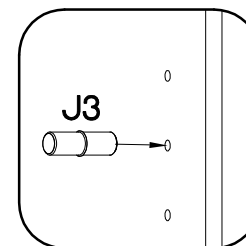

E13

4



30

±35/0mm	±3.5x13mm
	
HG	P5
4	8

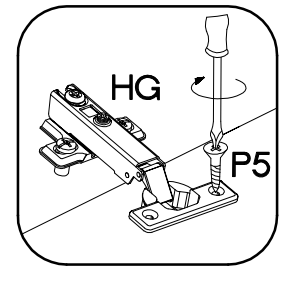
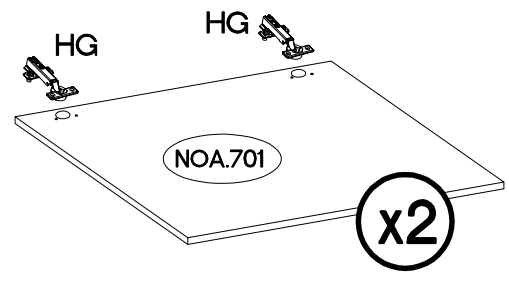

31

