

PRZED ROZPOCZĘCIEM MONTAŻU ZAPOZNAĆ SIĘ Z INSTRUKCJĄ

Narzędzia niezbędne do montażu (nie dostarczane przez producenta)

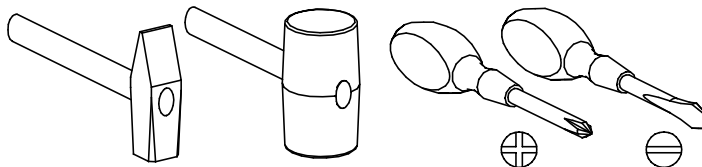

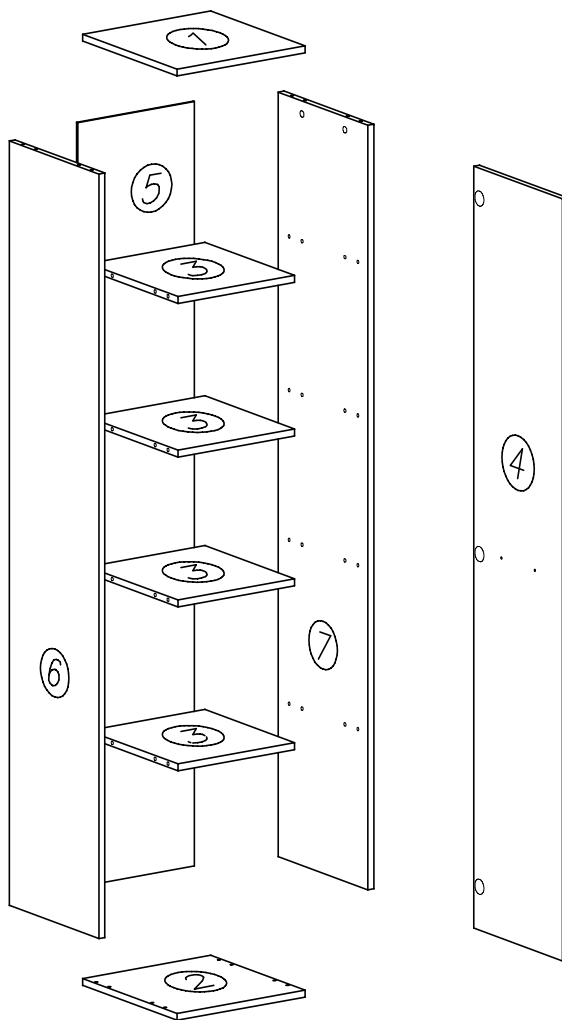
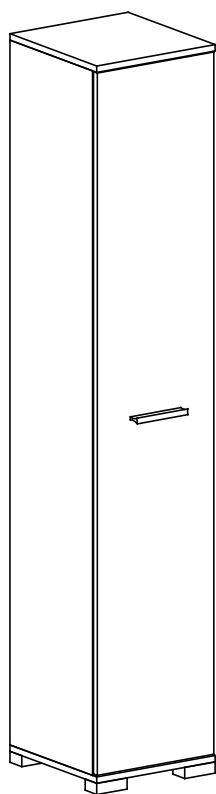

09

Nr	Nazwa elementu	Dł [mm]	Szer [mm]	Gr [mm]	Ilość	Kod	Paczka
1	blat górny	350	368	16	1		
2	blat dolny	350	368	16	1		
3	wieniec	317	347	16	4		
4	drzwi	345	1763	16	1		
5	HDF ściana tylna	1789	338	2,5	1		
6	bok lewy	1769	350	16	1		
7	bok prawy	1769	350	16	1		





G34   
3,5 x 16 x6

G23   
4 x 40 x8

W4   
x50

K5   
x20

P23   
x4

K1   
ø15 x 12 x20

B1   
x24

C3   
Z35PR x3

G16   
4 x 27 x2

D3   
PZ35PR x3

W2   
x1

E7   
x1

A1   
ø7 x 50 x4

I

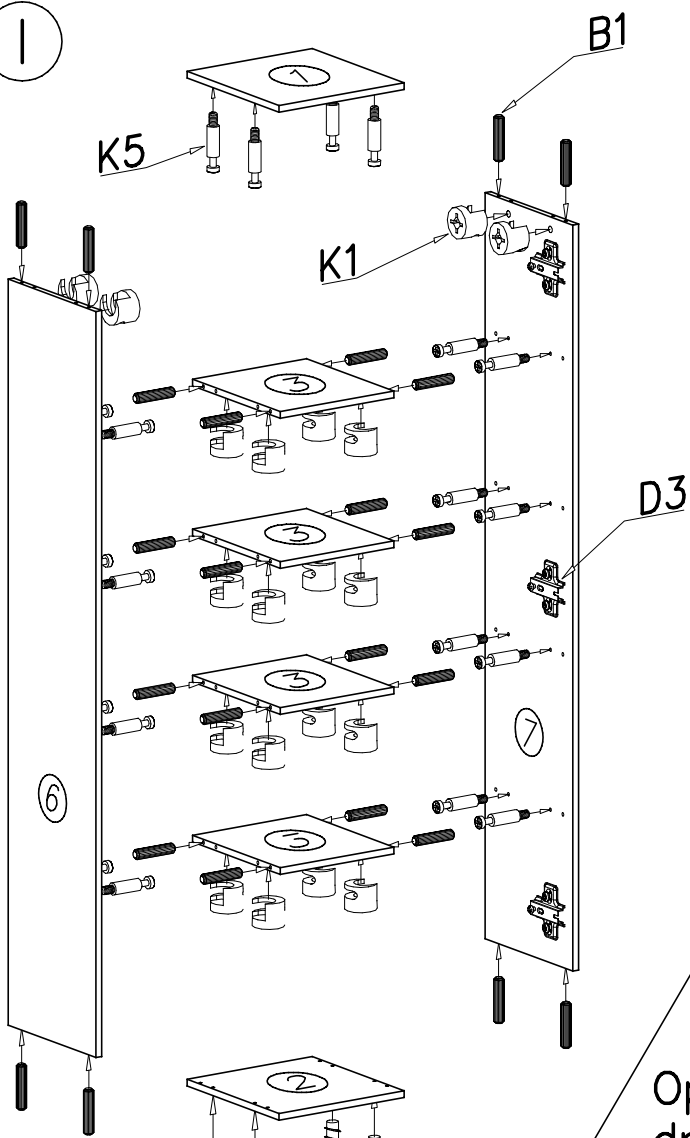

II

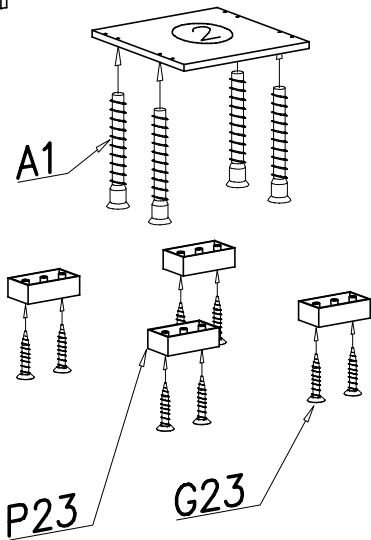
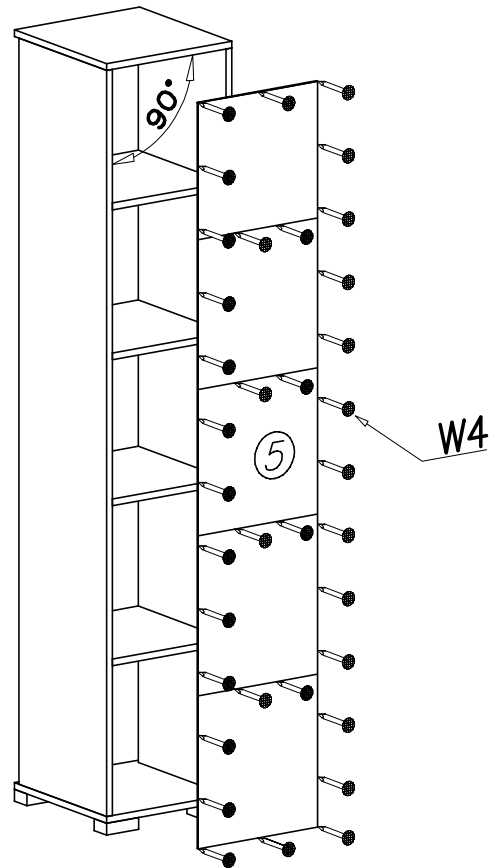

III

Opcja: drzwi lewe

Opcja: drzwi prawe

