

PRZED ROZPOCZĘCIEM MONTAŻU ZAPOZNAĆ SIĘ Z INSTRUKCJĄ

Narzędzia niezbędne do montażu (nie dostarczane przez producenta)

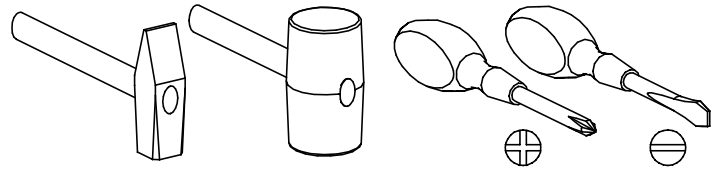
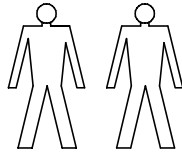

14

Nr	Nazwa elementu	Dł [mm]	Szer [mm]	Gr [mm]	Ilość	Kod	Paczka
1	półka górna	963	280	16	1		
2	półka środkowa	963	280	16	1		
3	bok górny	217	200	16	2		
4	bok dolny	217	200	16	2		
5	tył lewy	643	174	16	1		
6	tył prawy	643	174	16	1		
7	półka dolna	963	280	16	1		

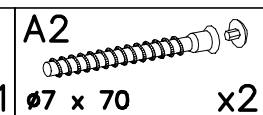
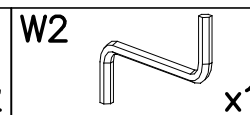
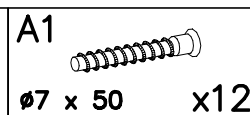
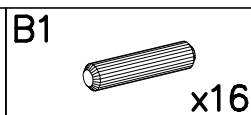
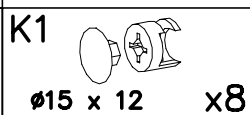
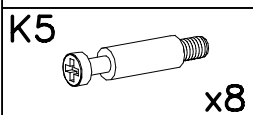
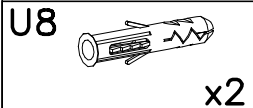
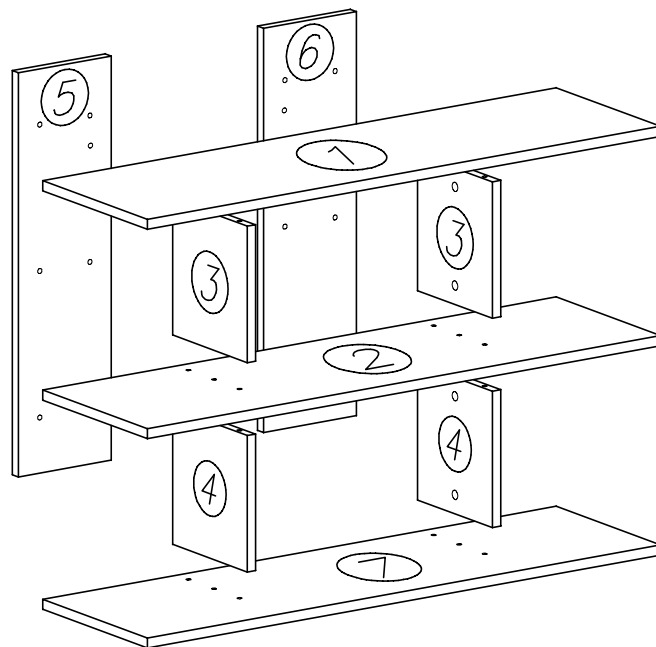
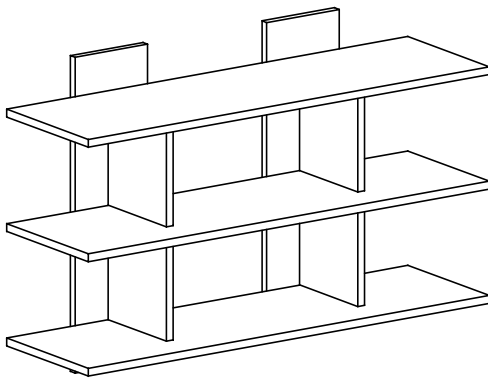

1

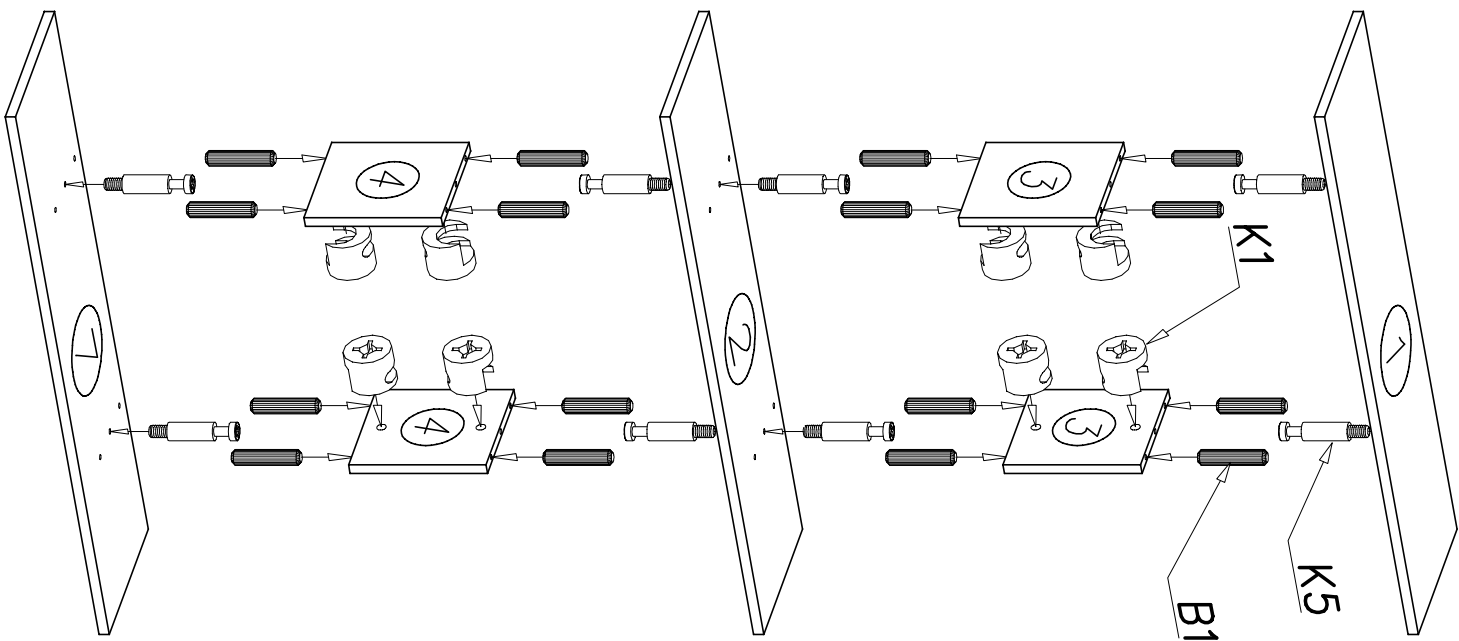

II

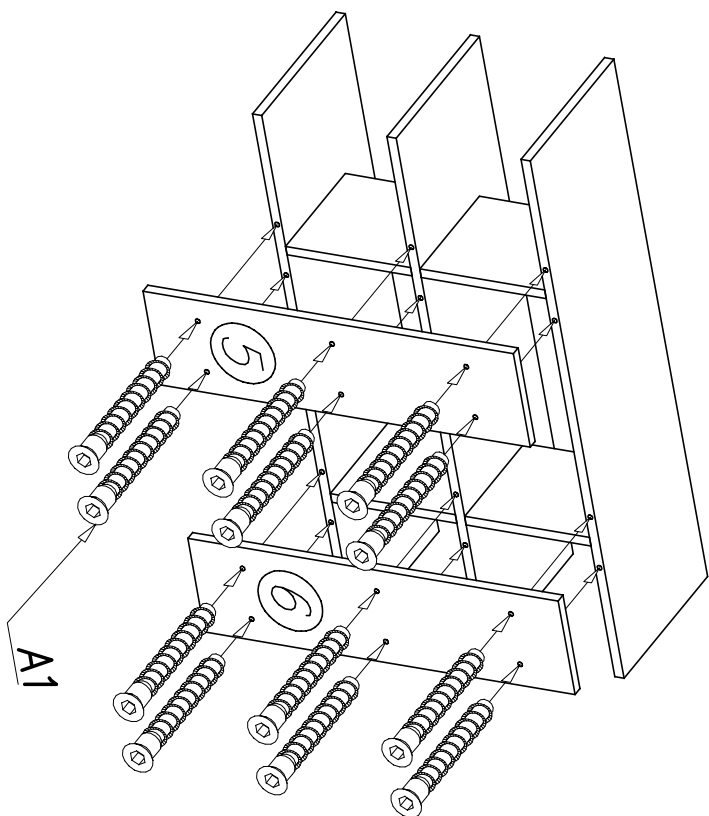

III

