

# VEGAS 36

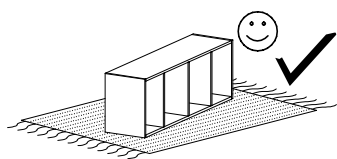

Narzędzia potrzebne do montażu



## UWAGA !!!

MONTOWANIE USZKODZONYCH  
ELEMENTÓW POWODUJE UTRATĘ  
GWARANCJI

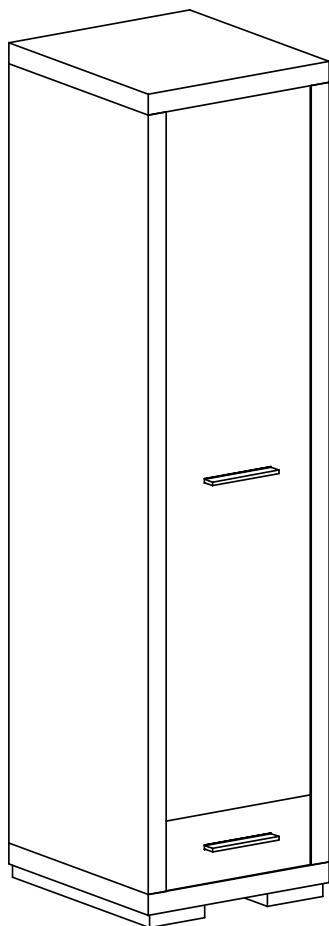

Nr	D[mm]	S[mm]	G[mm]	Ilość
1	492	542	48	1
2	492	542	48	1
3	522	458	16	1
4	1793	540	48	1
5	1793	540	48	1
6	388	1590	16	1
7	1820	482	2,5	1
8	388	190	16	1
9	500	165	16	1
10	337	165	16	1
11	500	165	16	1
12	368	505	2,5	1

W przypadku reklamacji proszę podać numer pakowacza znajdujący się na kartonie.

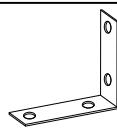

**Y - 2 St.**

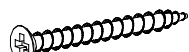

**R - 6 St.**  
4x60 mm

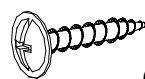

**Q - 4 St.**  
3,5x16 mm

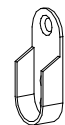

**A - 2 St.**

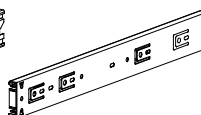
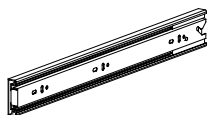

**T - 1 Kpl.**

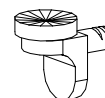

**P - 1 St.**

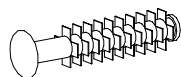

**F - 4 St.**

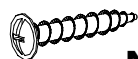

**N - 4 St.**  
4x30 mm



**U - 2 St.**



**G - 10 St.**  
3,5x16 mm



**L - 16 St.**



**O - 1 St.**



**M - 14 St.**  
3x30 mm

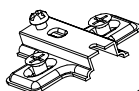

**C - 3 St.**

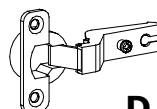

**D - 3 St.**



**S - 1 St.**



**E - 50 St.**



**B - 20 St.**

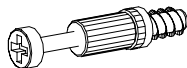

**K - 16 St.**



**Z - 1 St.**



**J - 8 St.**  
5x13 mm

# I VEGA 36

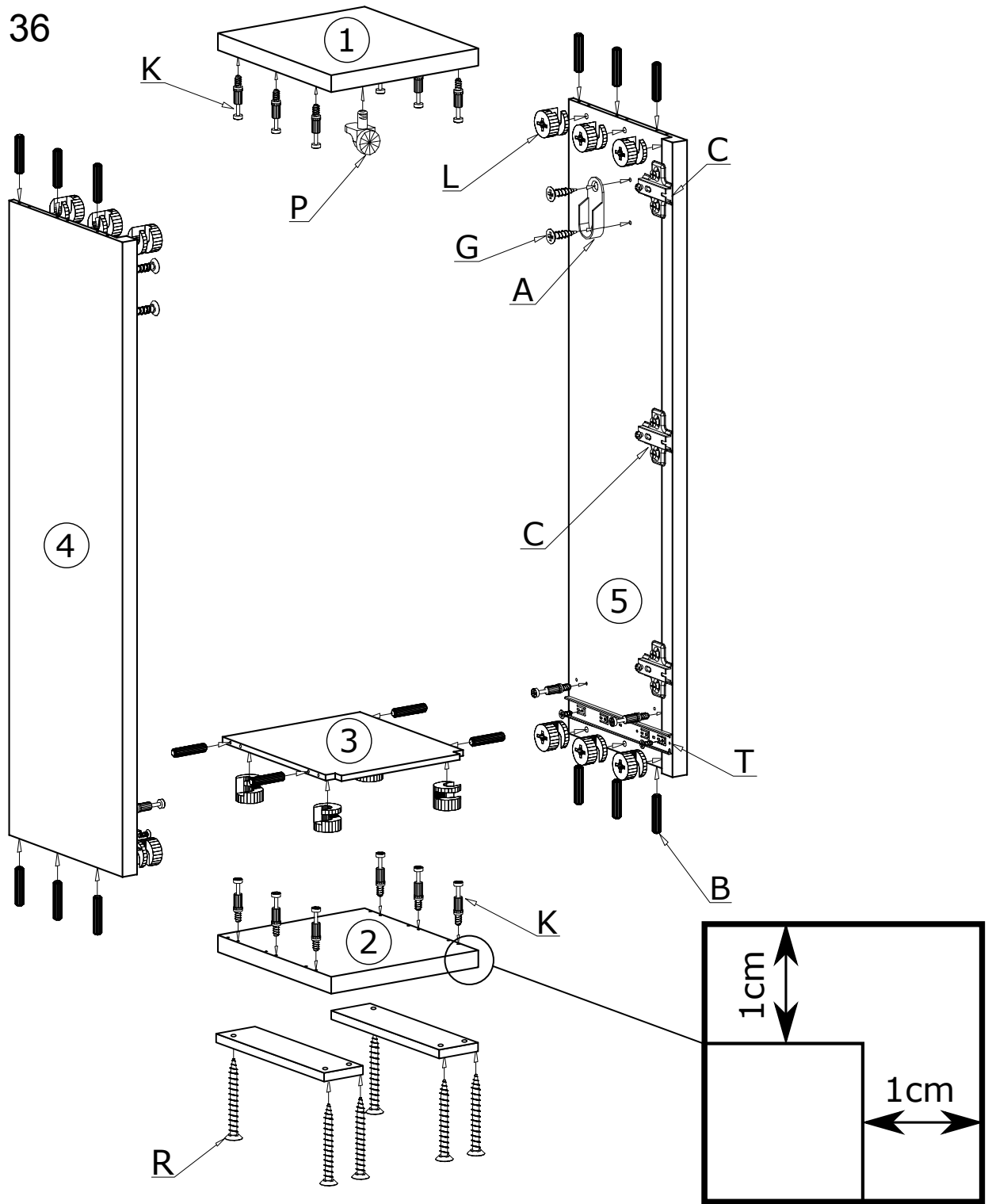

# II

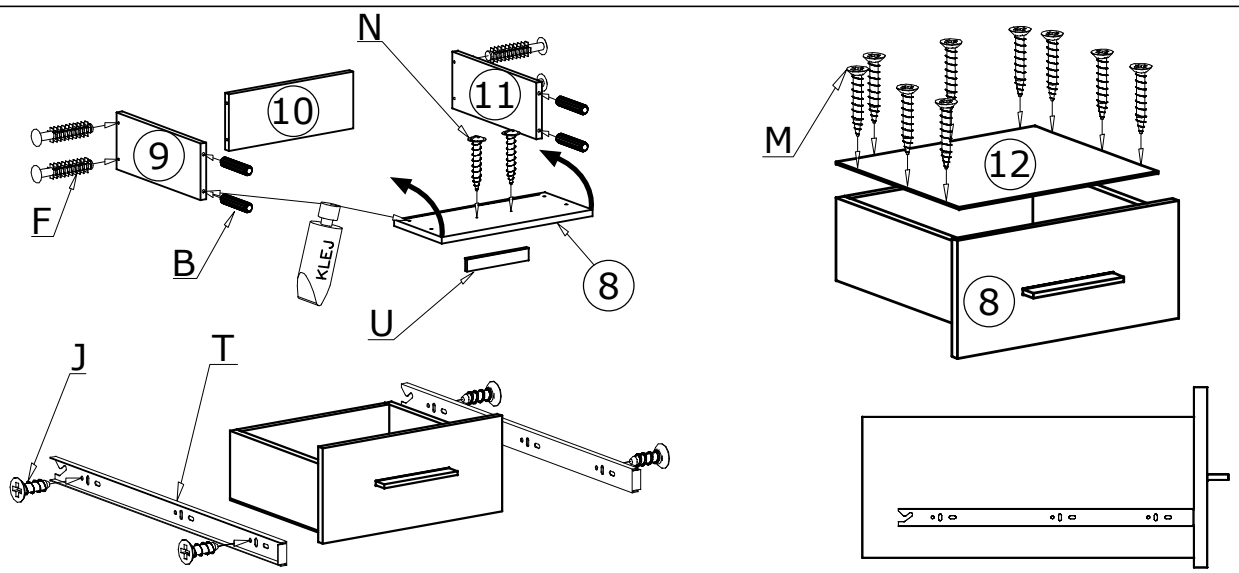

III

50X

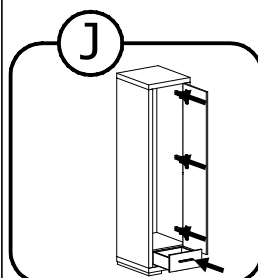
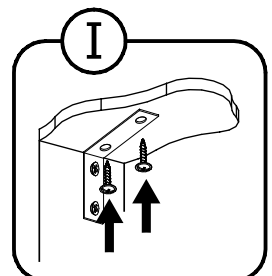
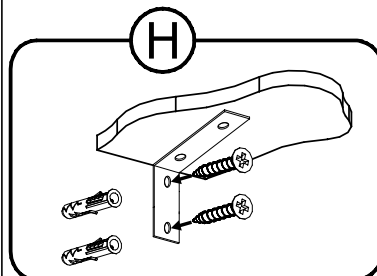
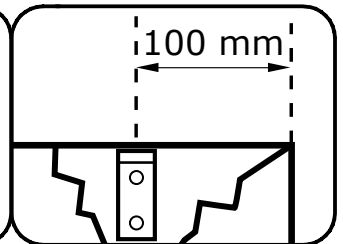
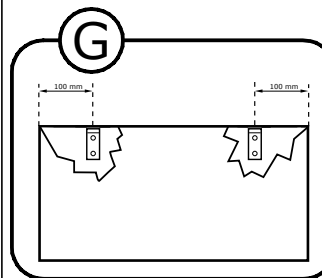
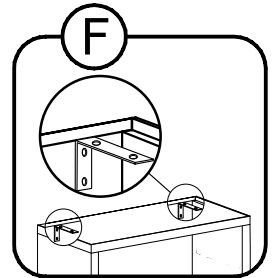
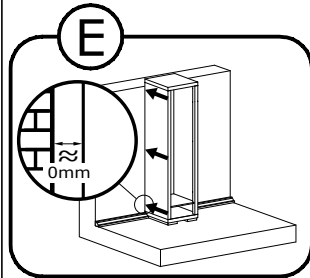
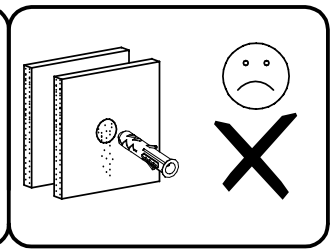
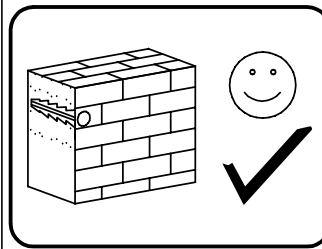
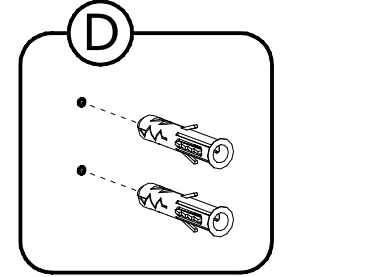
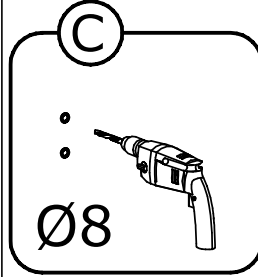
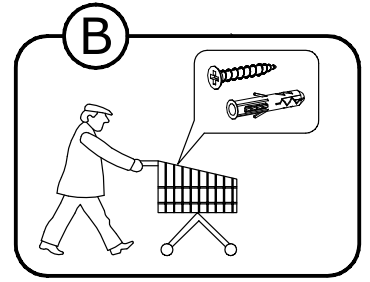
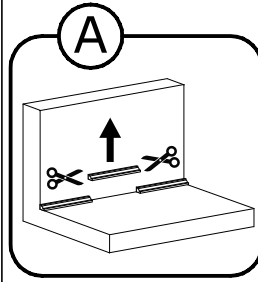
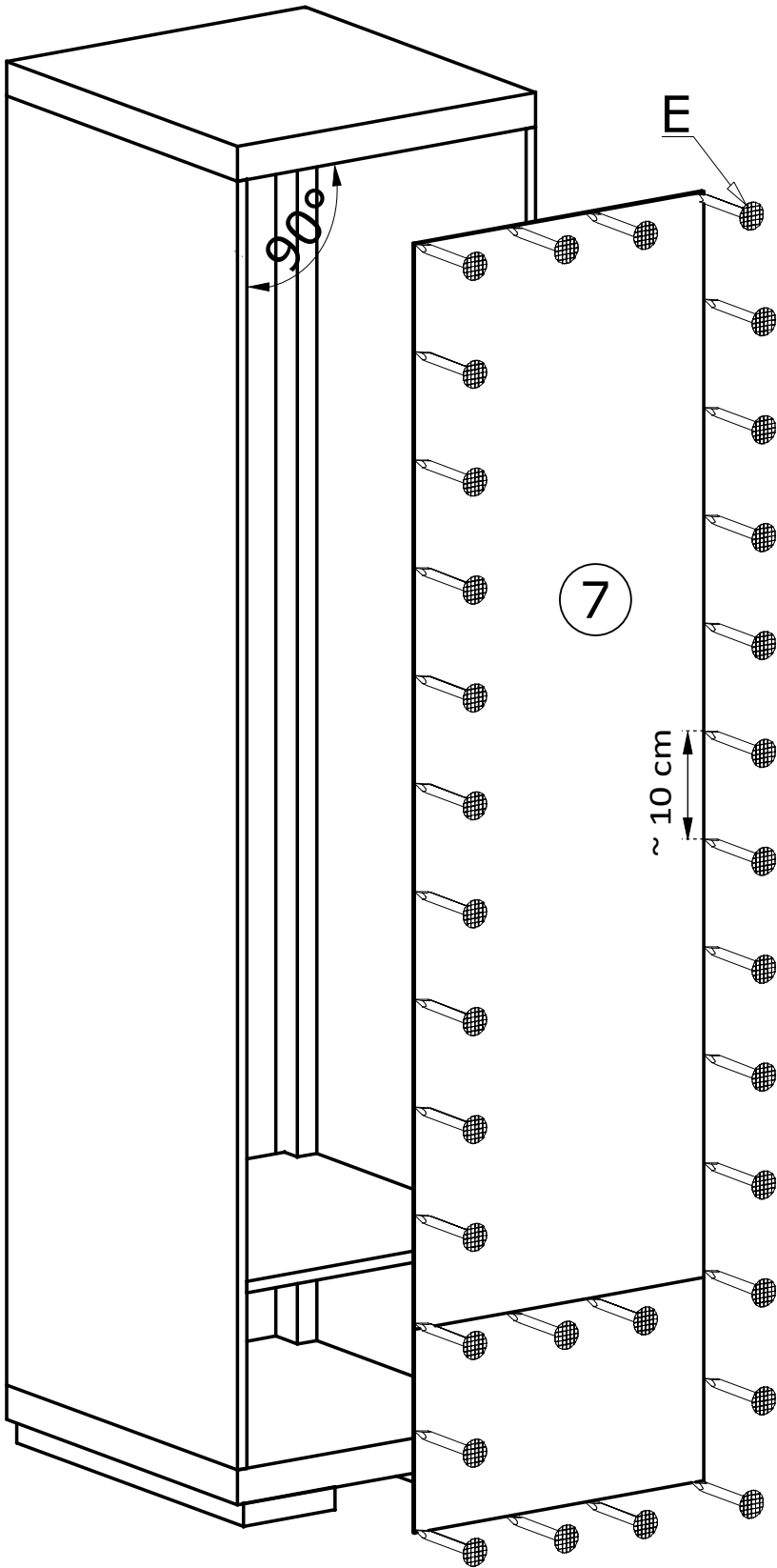

IV

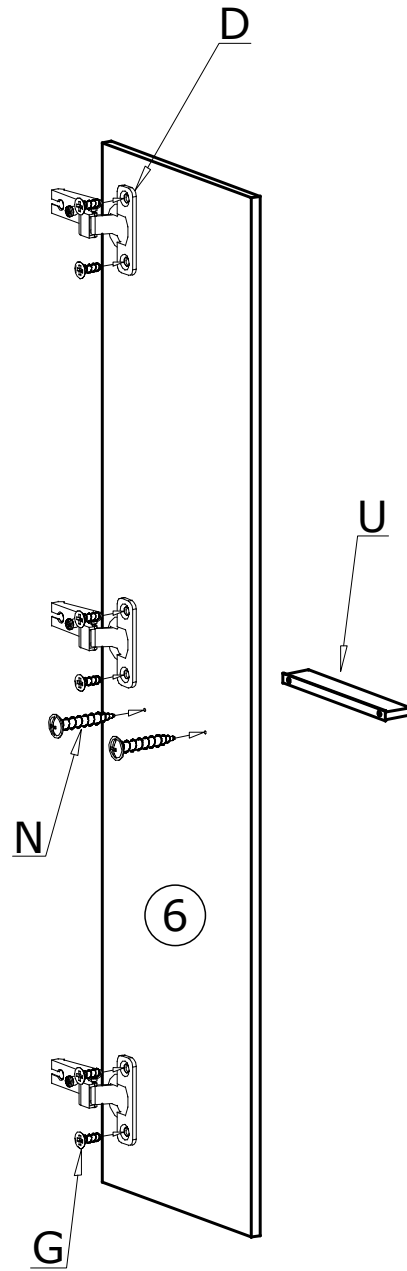
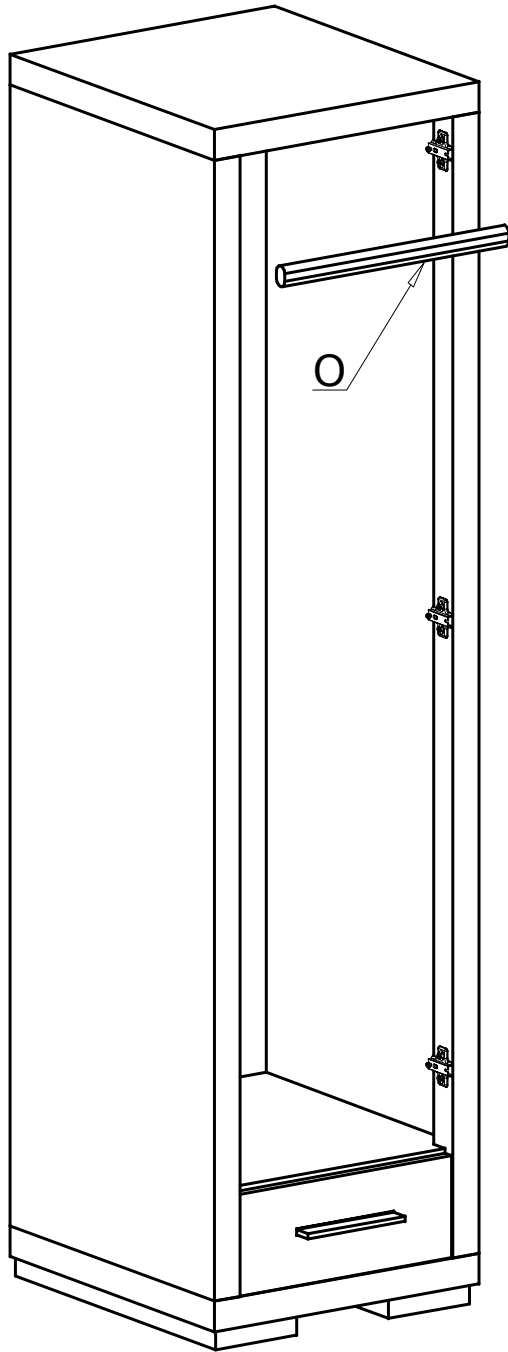

1

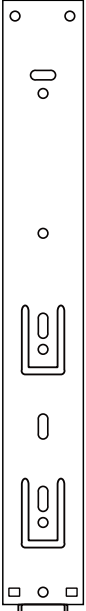

2

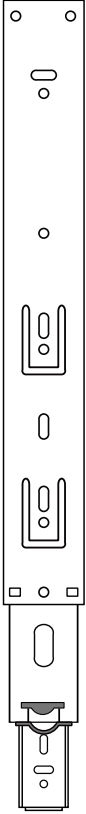

3

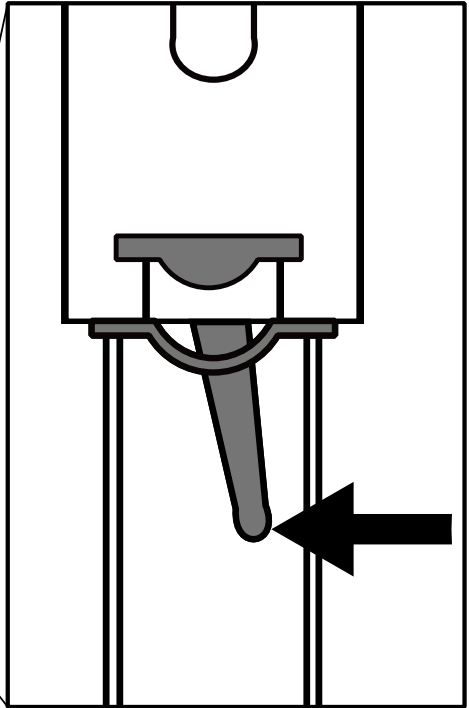

4

