

TITANUS 16



Narzędzia potrzebne do montażu



UWAGA !!!

MONTOWANIE USZKODZONYCH
ELEMENTÓW POWODUJE UTRATĘ
GWARANCJI

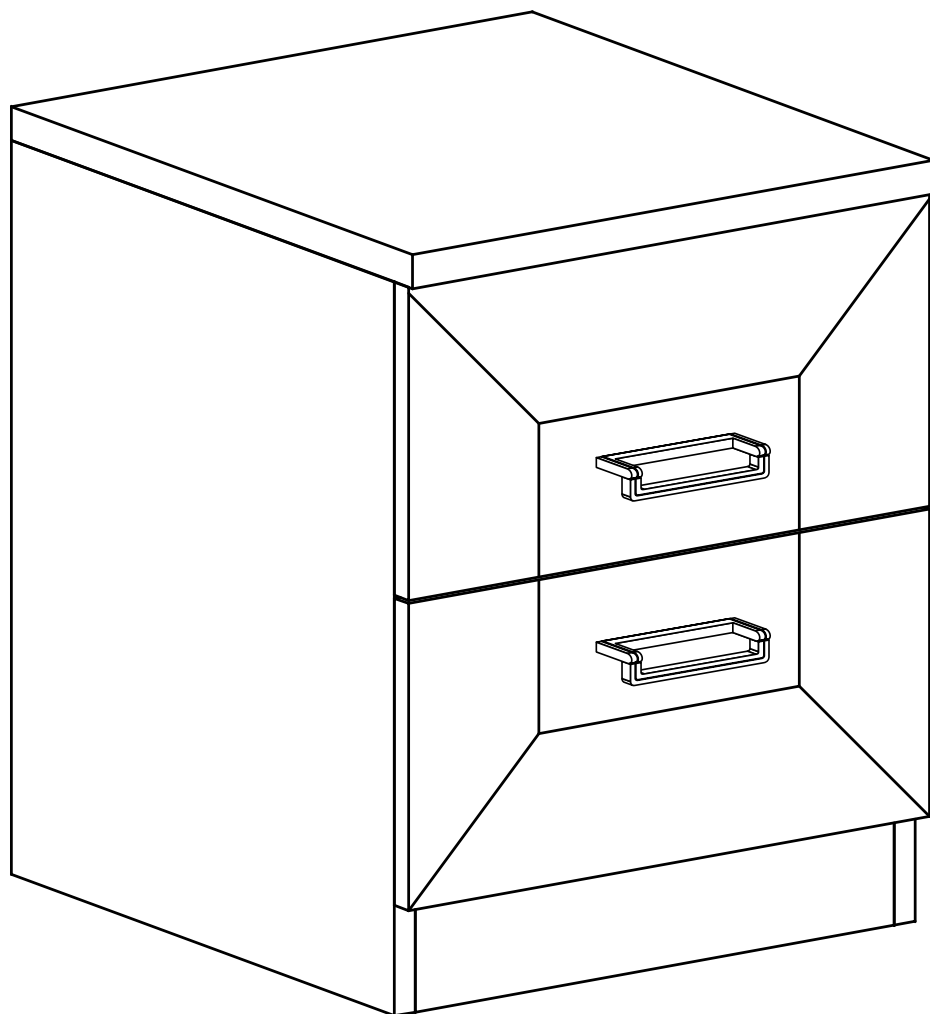

Nr	D[mm]	S[mm]	G[mm]	Ilość
1	440	400	32	1
2	405	352	16	1
3	475	405	16	1
4	475	405	16	1
5	352	80	16	1
6	420	380	2,5	1
7	296	150	16	2
8	400	150	16	2
9	400	150	16	2
10	382	190	16	2
11	405	323	2,5	2

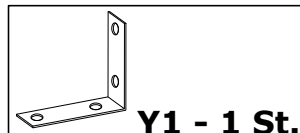

Y1 - 1 St.

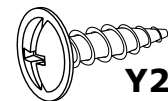

Y2 - 2 St.
3,5x16 mm



X2 - 4 St.

W przypadku reklamacji proszę podać numer pakowacza znajdujący się na kartonie.

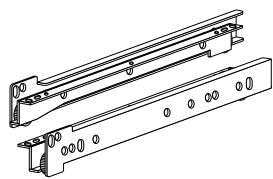

T - 2 Kpl.

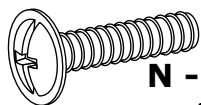

N - 4 St.
4x22 mm



U - 2 St.

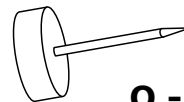

Q - 4 St.



X1 - 8 St.



E - 40 St.

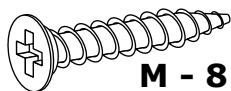

M - 8 St.
4x25 mm

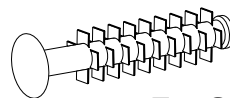

F - 8 St.

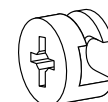

L - 8 St.

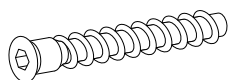

R - 4 St.

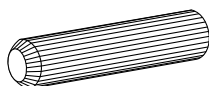

B - 20 St.

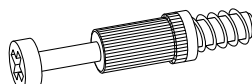

K - 8 St.



Z - 1 St.

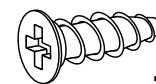

J - 8 St.
5x13 mm

I

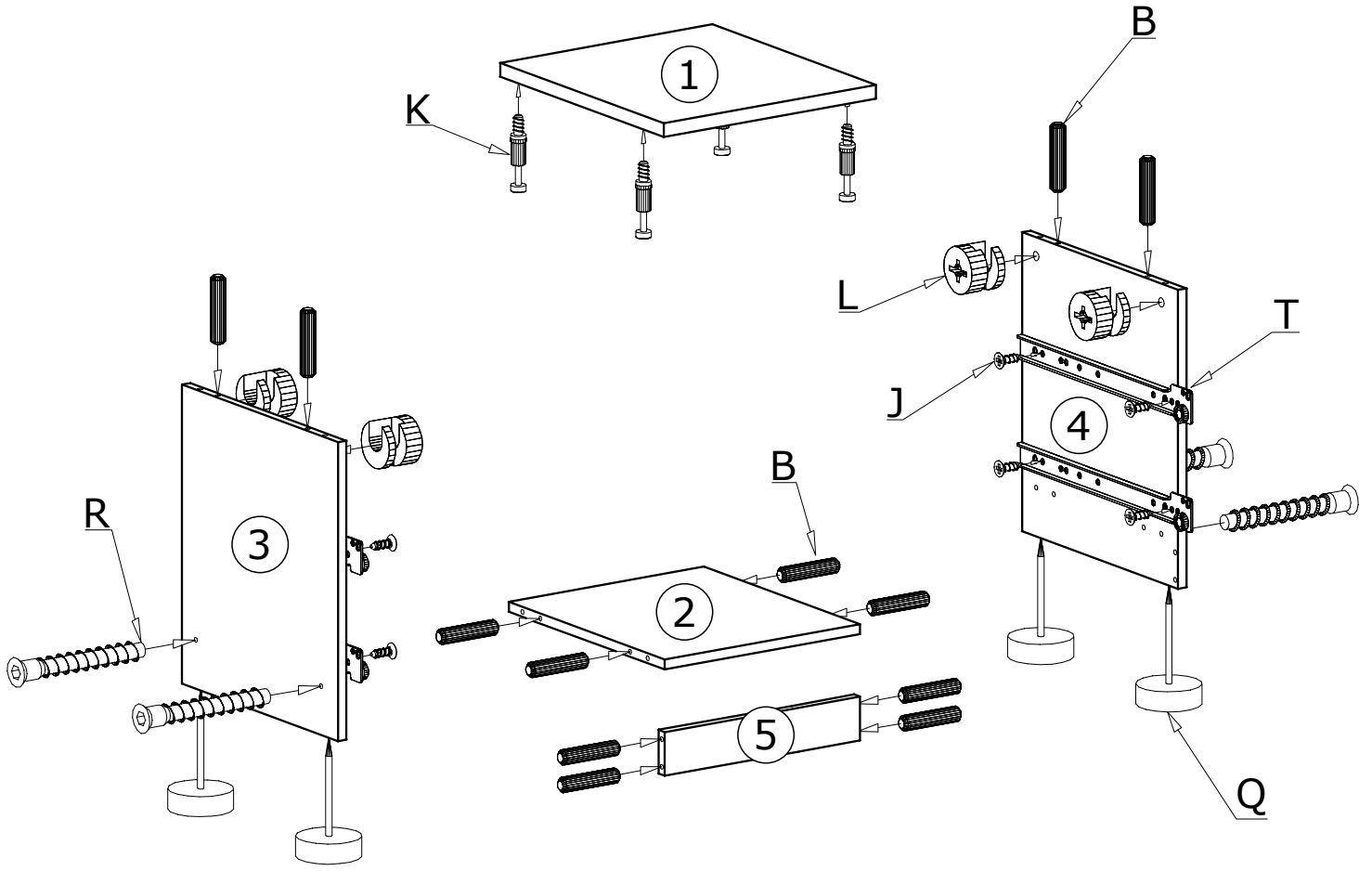

II

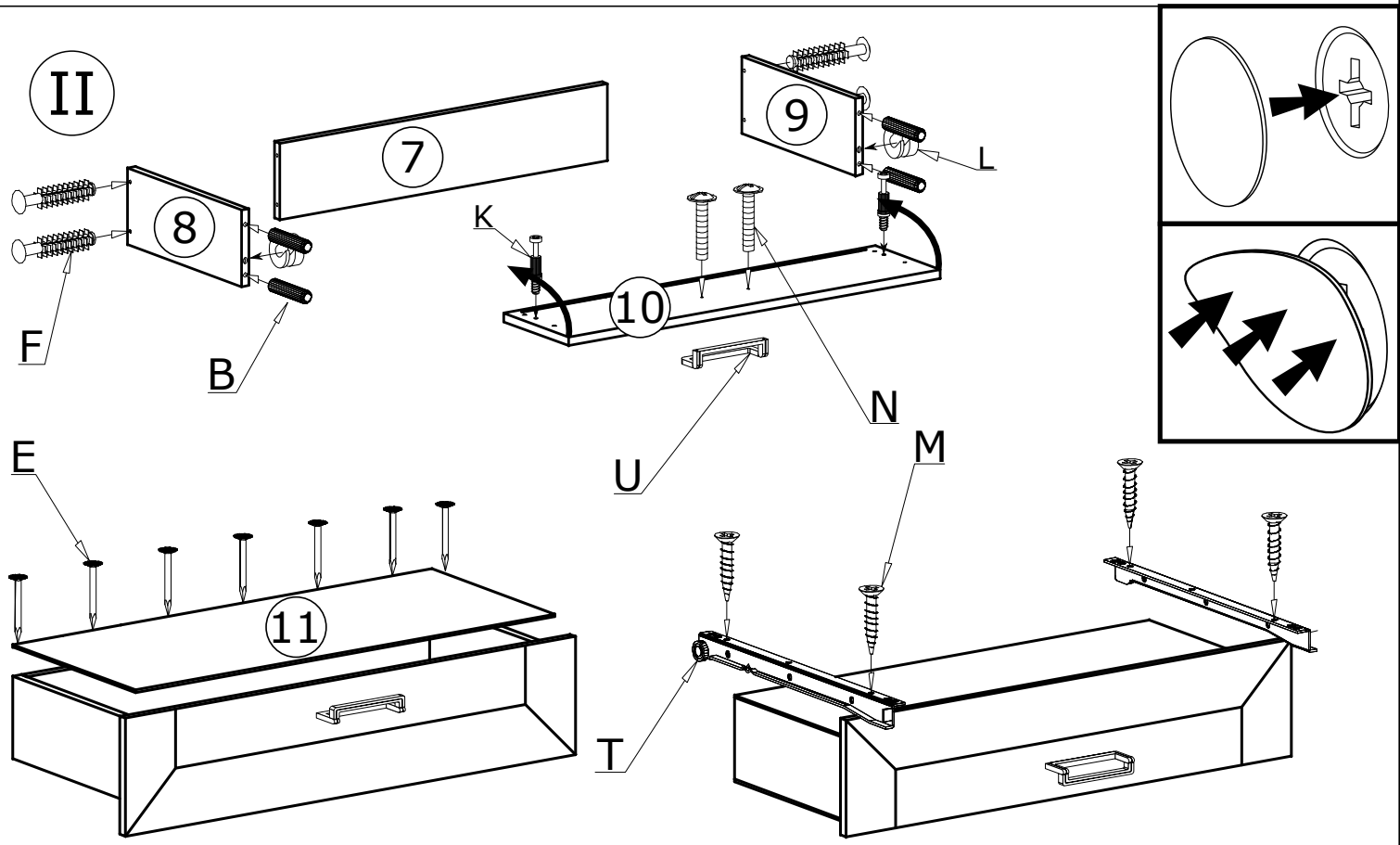

III

40X 

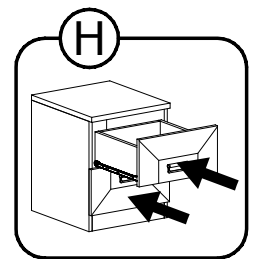
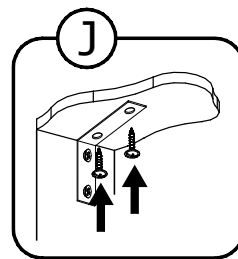
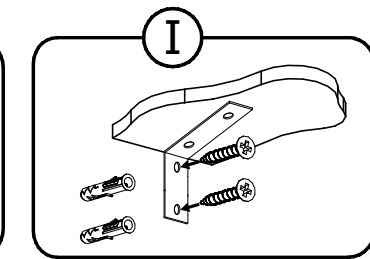
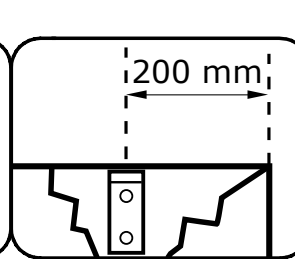
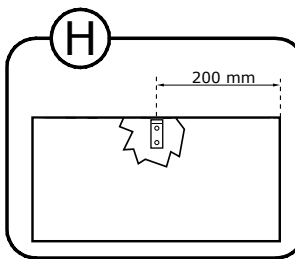
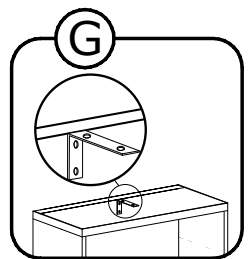
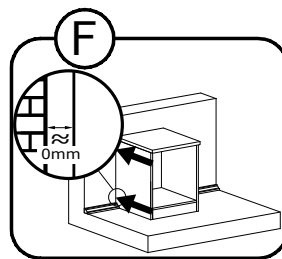
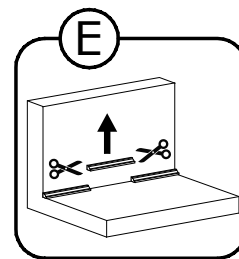
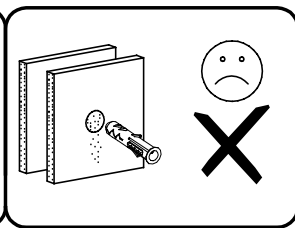
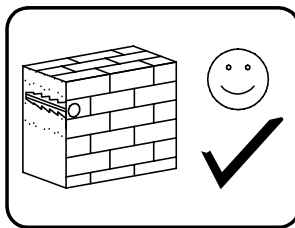
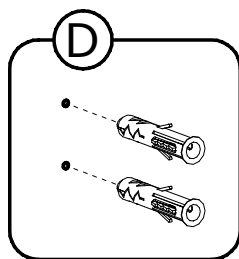
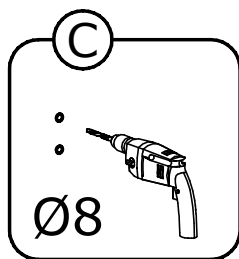
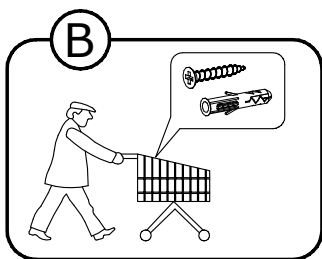
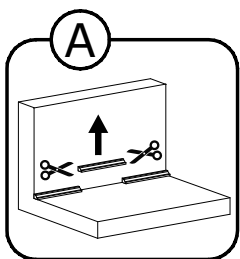
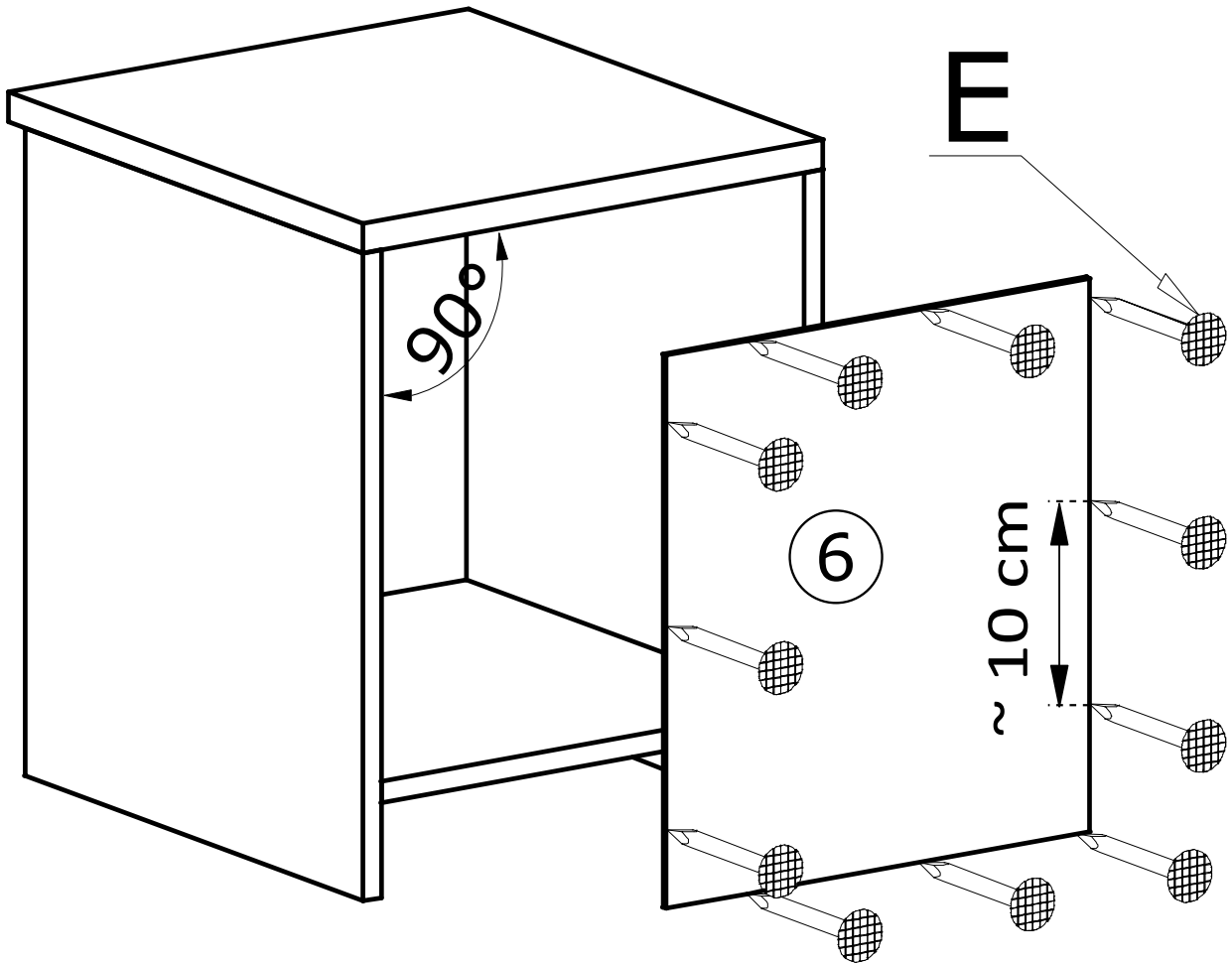

IV

