

# TITANUS 15

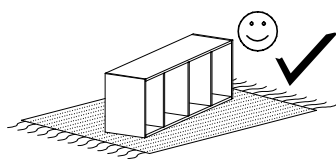

Narzędzia potrzebne do montażu

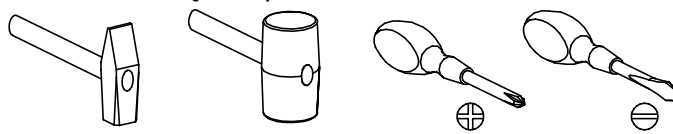

## UWAGA !!!

MONTOWANIE USZKODZONYCH  
ELEMENTÓW POWODUJE UTRATĘ  
GWARANCJI

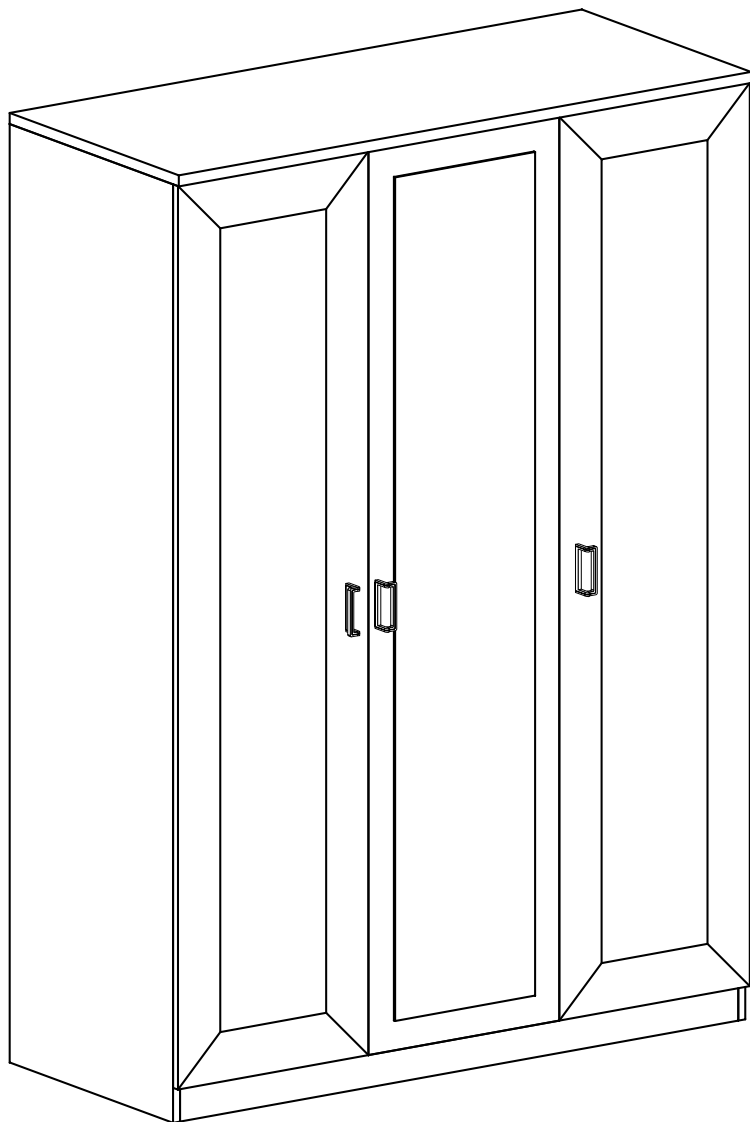

Nr	D[mm]	S[mm]	G[mm]	Ilość
1	1345	570	32	1
2	1298	540	16	1
3	1775	540	16	1
4	1298	80	16	2
5	510	423	16	4
6	1870	540	16	1
7	1870	540	16	1
8	1800	440	2,5	1
9	1800	880	2,5	1
10	858	510	16	1
11	1780	438	16	1
12	1780	438	16	1
13	1780	438	16	1

W przypadku reklamacji proszę podać numer pakowacza znajdujący się na kartonie.



**X1 - 9 St.**



**X2 - 4 St.**

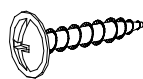

**I - 4 St.**  
3,5x16 mm

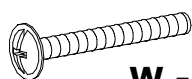

**W - 4 St.**  
4x37 mm



**Y - 10 St.**

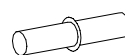

**P - 20 St.**

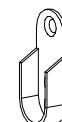

**Y - 2 St.**

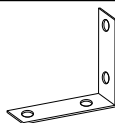

**O - 2 St.**

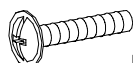

**N - 2 St.**  
4x25 mm



**U - 3 St.**



**G - 32 St.**  
3,5x16 mm



**L - 10 St.**

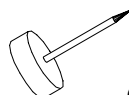

**Q - 6 St.**



**E - 60 St.**

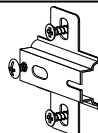

**C - 9 St.**

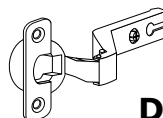

**D - 9 St.**



**S - 1 St.**

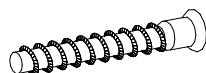

**R - 6 St.**



**B - 20 St.**

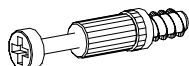

**K - 10 St.**

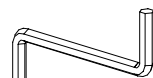

**Z - 1 St.**



**R - 1 St.**

I

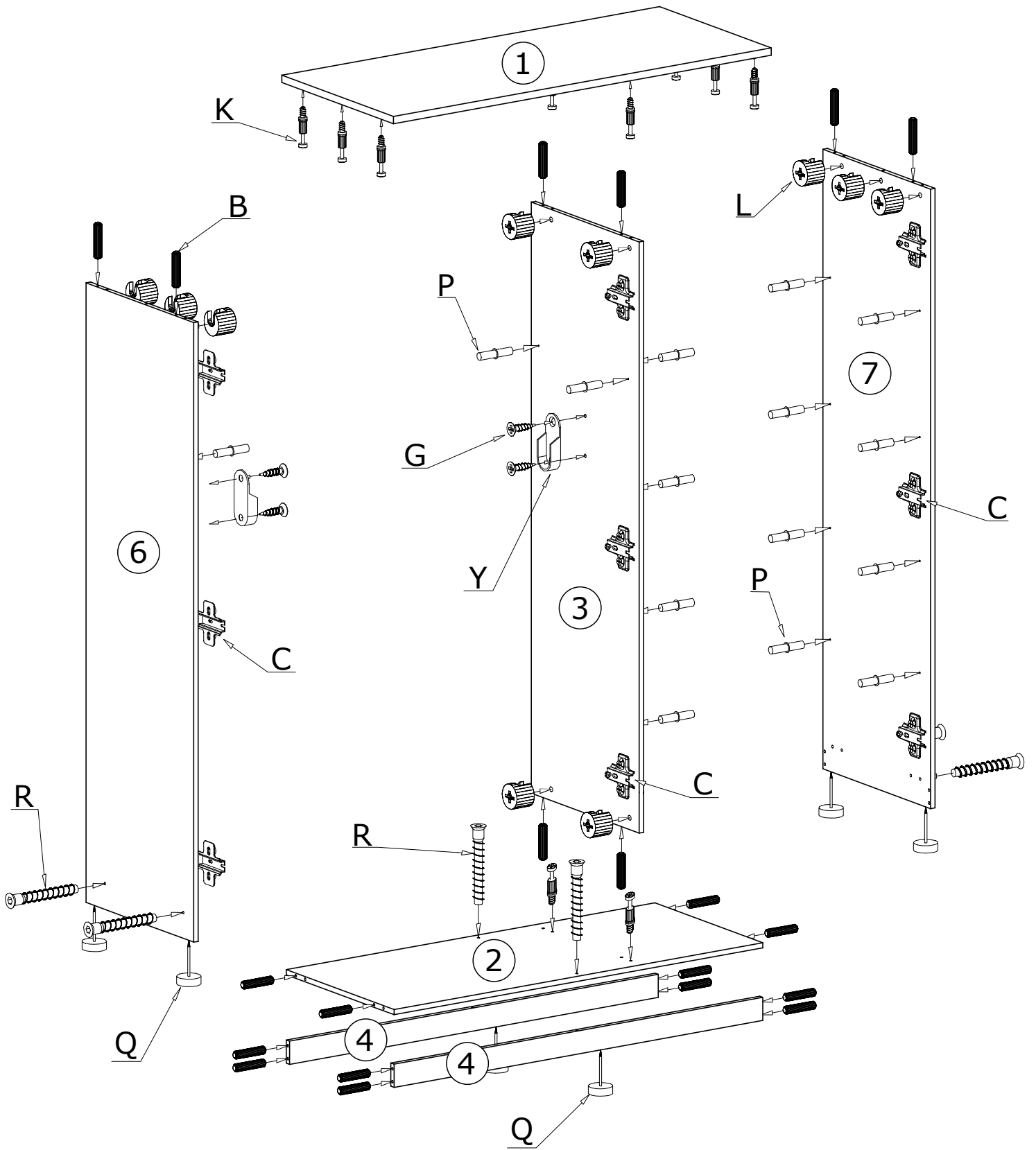

II

60X 

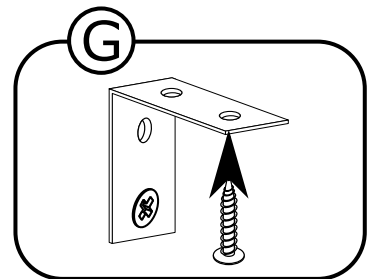
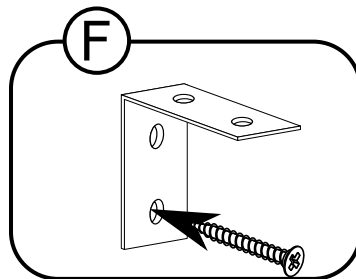
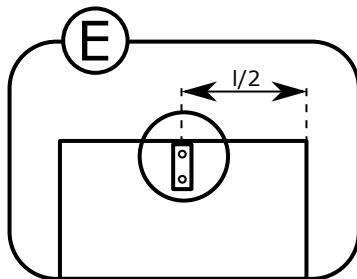
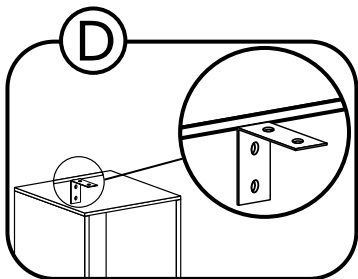
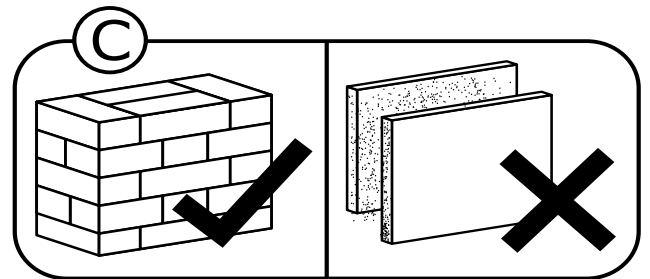
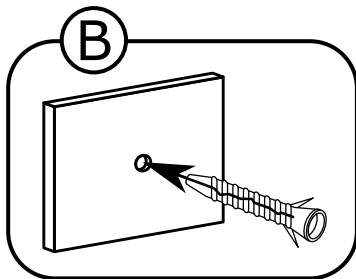
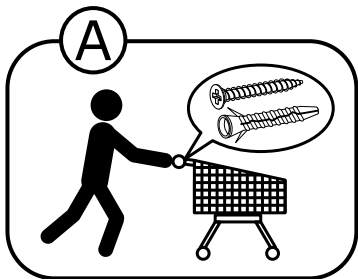
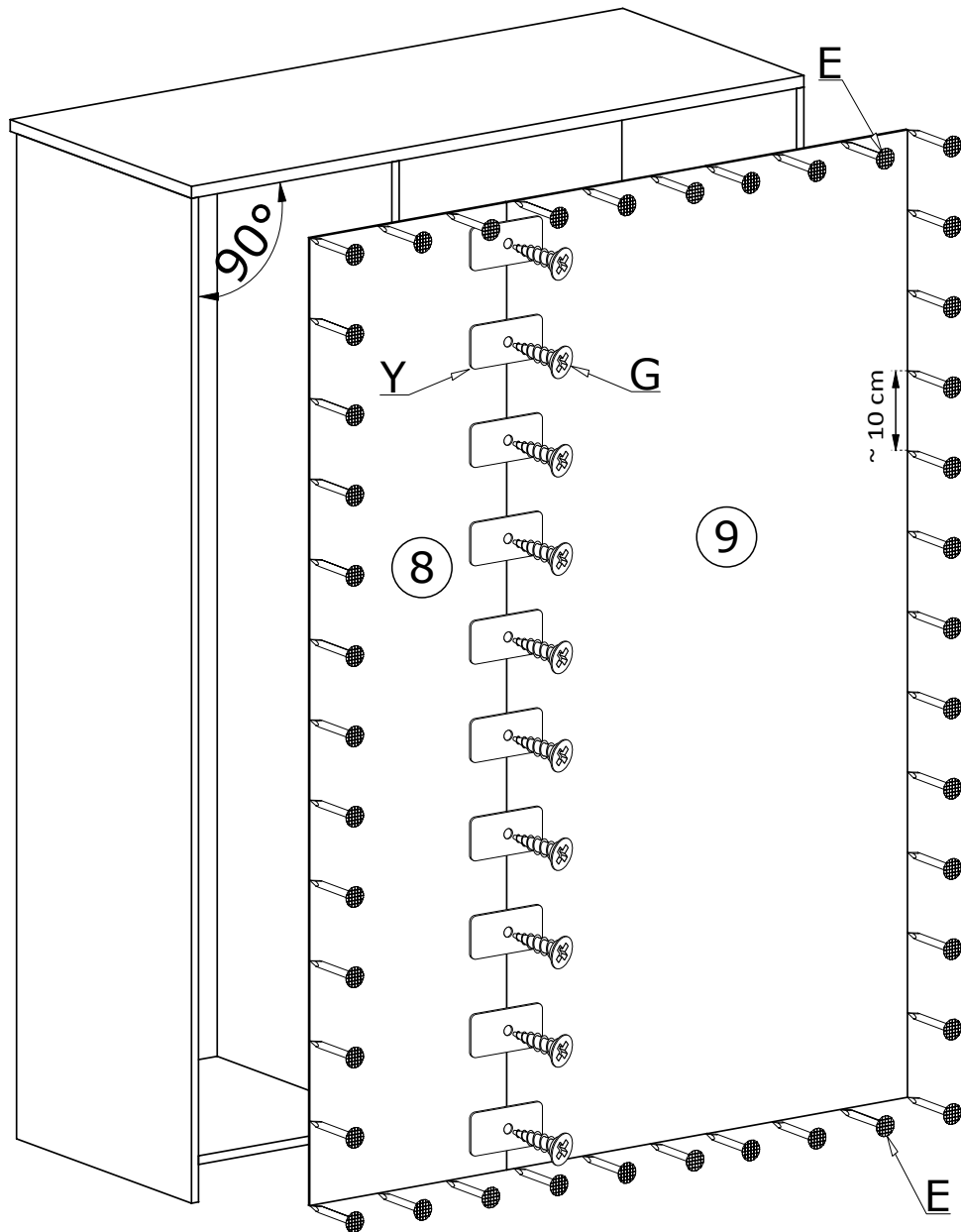

III

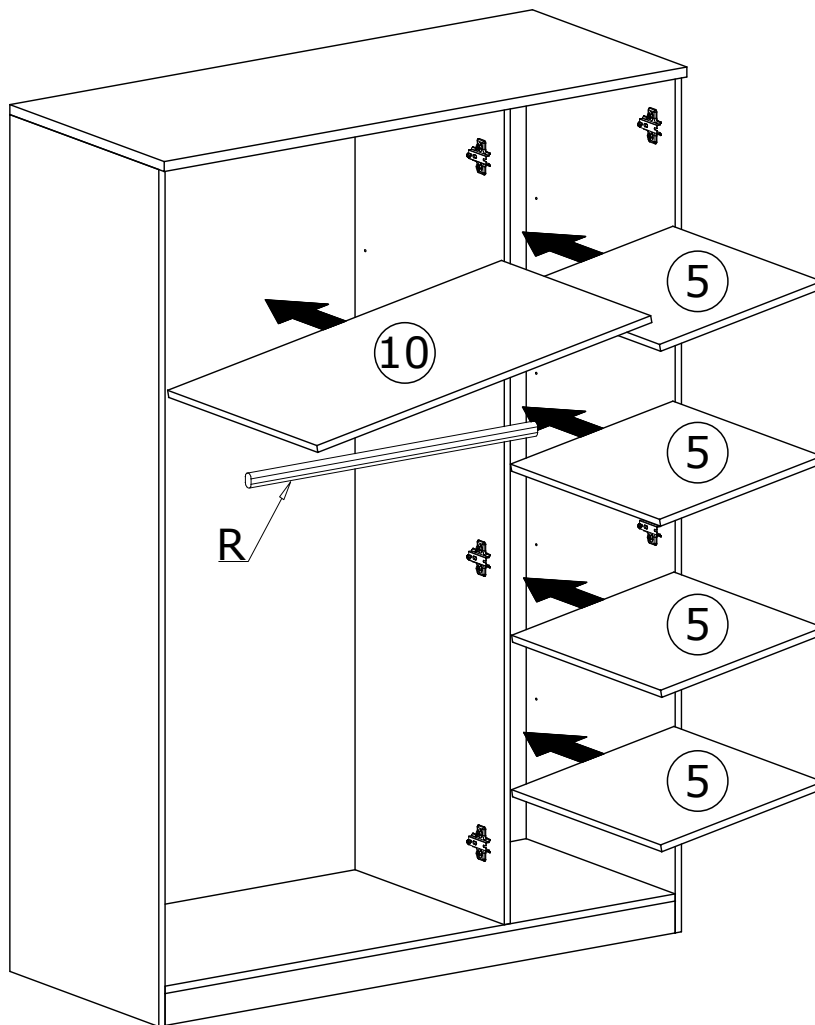

IV

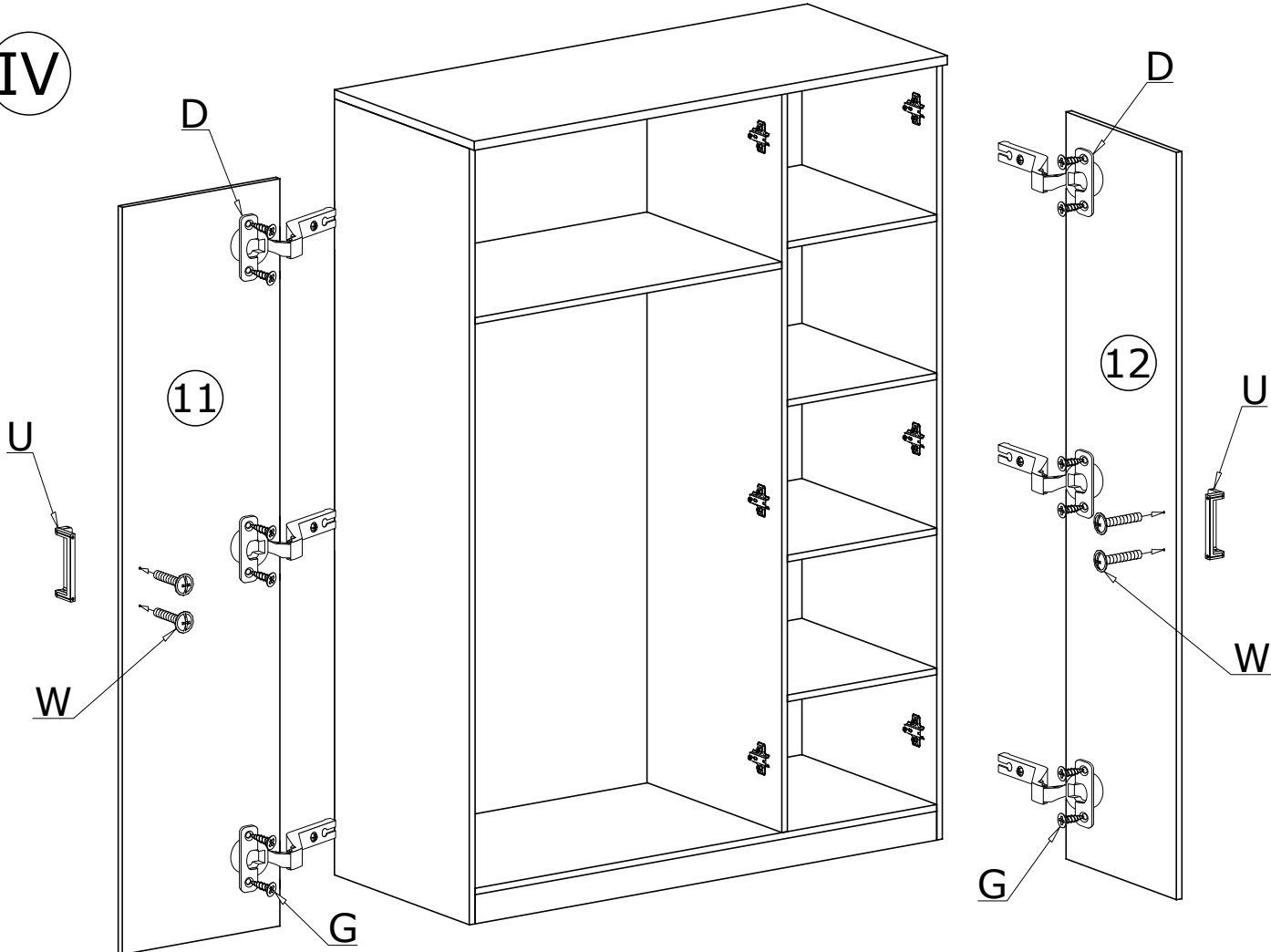

V

