

TITANUS 10

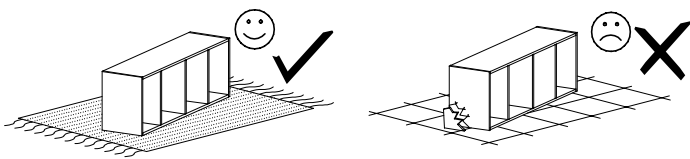

Narzędzia potrzebne do montażu

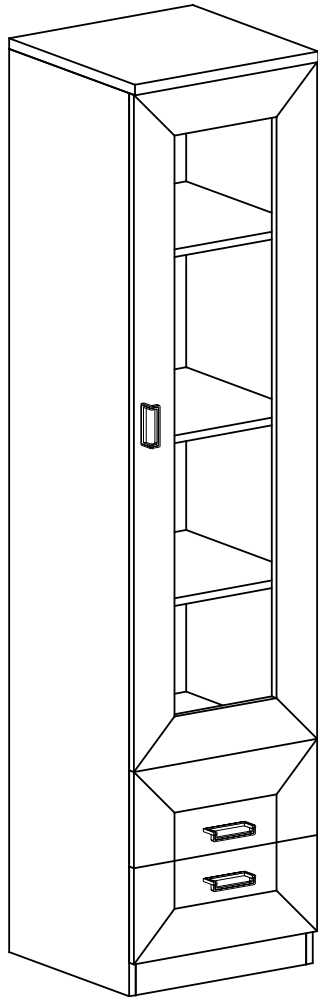
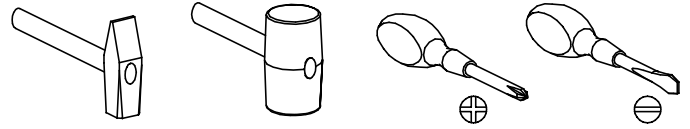

UWAGA !!!

MONTOWANIE USZKODZONYCH
ELEMENTÓW POWODUJE UTRATĘ
GWARANCJI

Nr	D[mm]	S[mm]	G[mm]	Ilość
1	460	440	32	1
2	412	405	16	1
3	412	405	16	1
4	412	80	16	1
5	412	380	16	3
6	1870	405	16	1
7	1870	405	16	1
8	1394	438	16	1
9	1800	438	2,5	1
10	440	190	16	2
11	400	150	16	2
12	400	150	16	2
13	355	150	16	2
14	405	380	2,5	2

W przypadku reklamacji proszę podać numer pakowacza znajdujący się na kartonie.

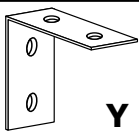

Y - 1 St.

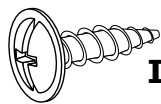

I - 2 St.
3,5x16 mm



X1 - 8 St.



X2 - 8 St.

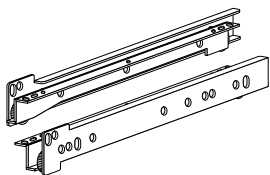

T - 2 Kpl.

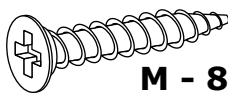

M - 8 St.
4x25 mm

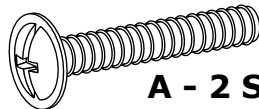

A - 2 St.
4x37 mm

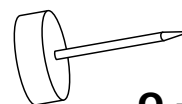

Q - 4 St.



X3 - 10 St.

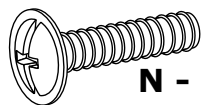

N - 4 St.
4x22 mm

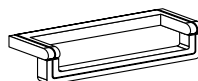

U - 3 St.

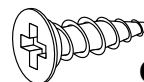

G - 6 St.
3,5x16 mm



P - 12 St.



F - 8 St.

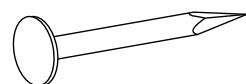

E - 50 St.

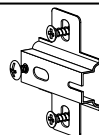

C - 3 St.

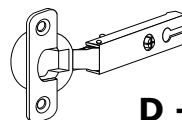

D - 3 St.

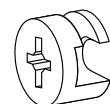

L - 8 St.



R - 8 St.

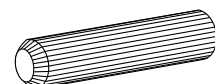

B - 24 St.

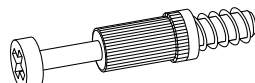

K - 8 St.



Z - 1 St.

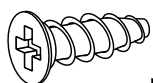

J - 8 St.
5x13 mm

I

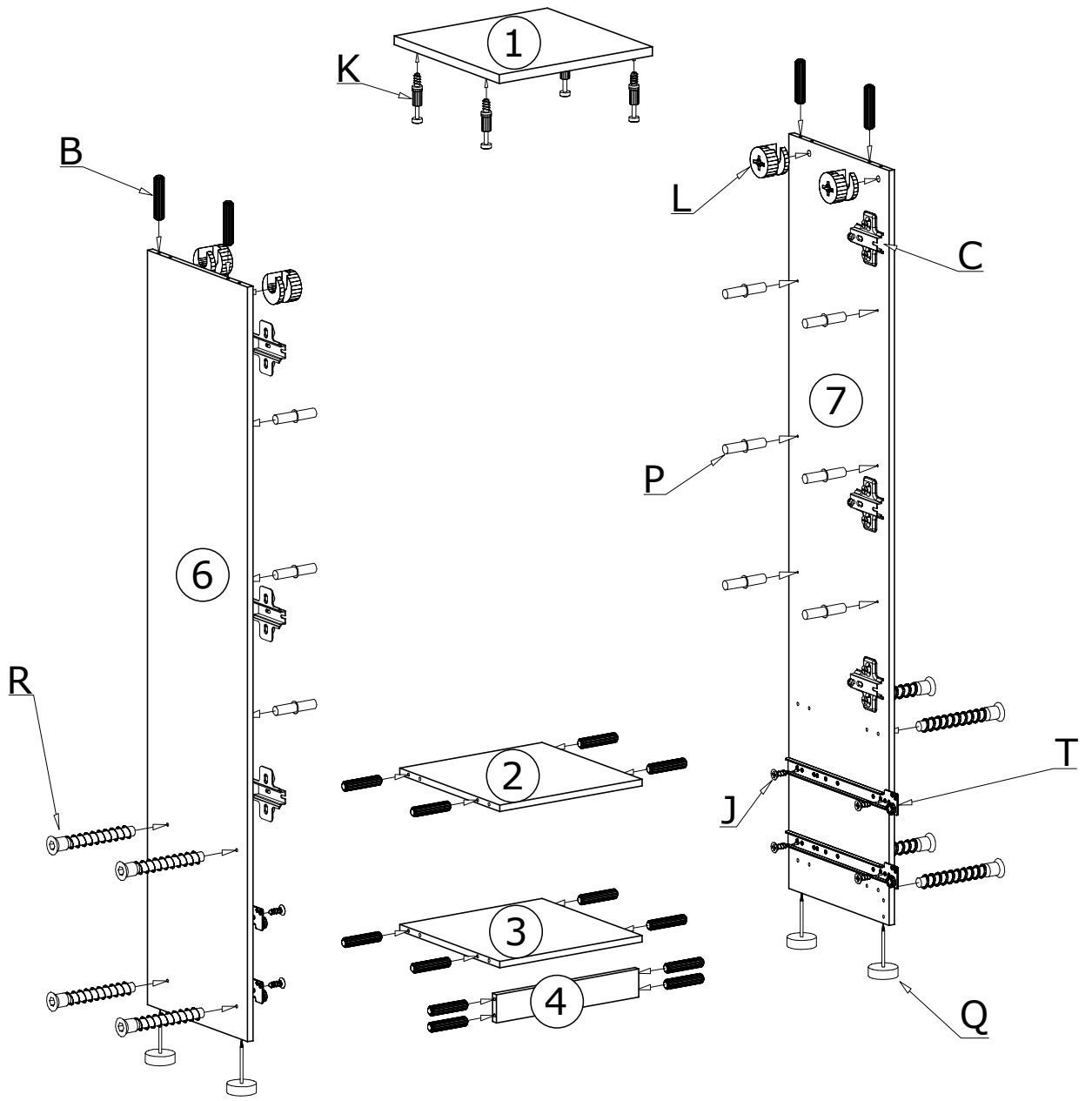

II

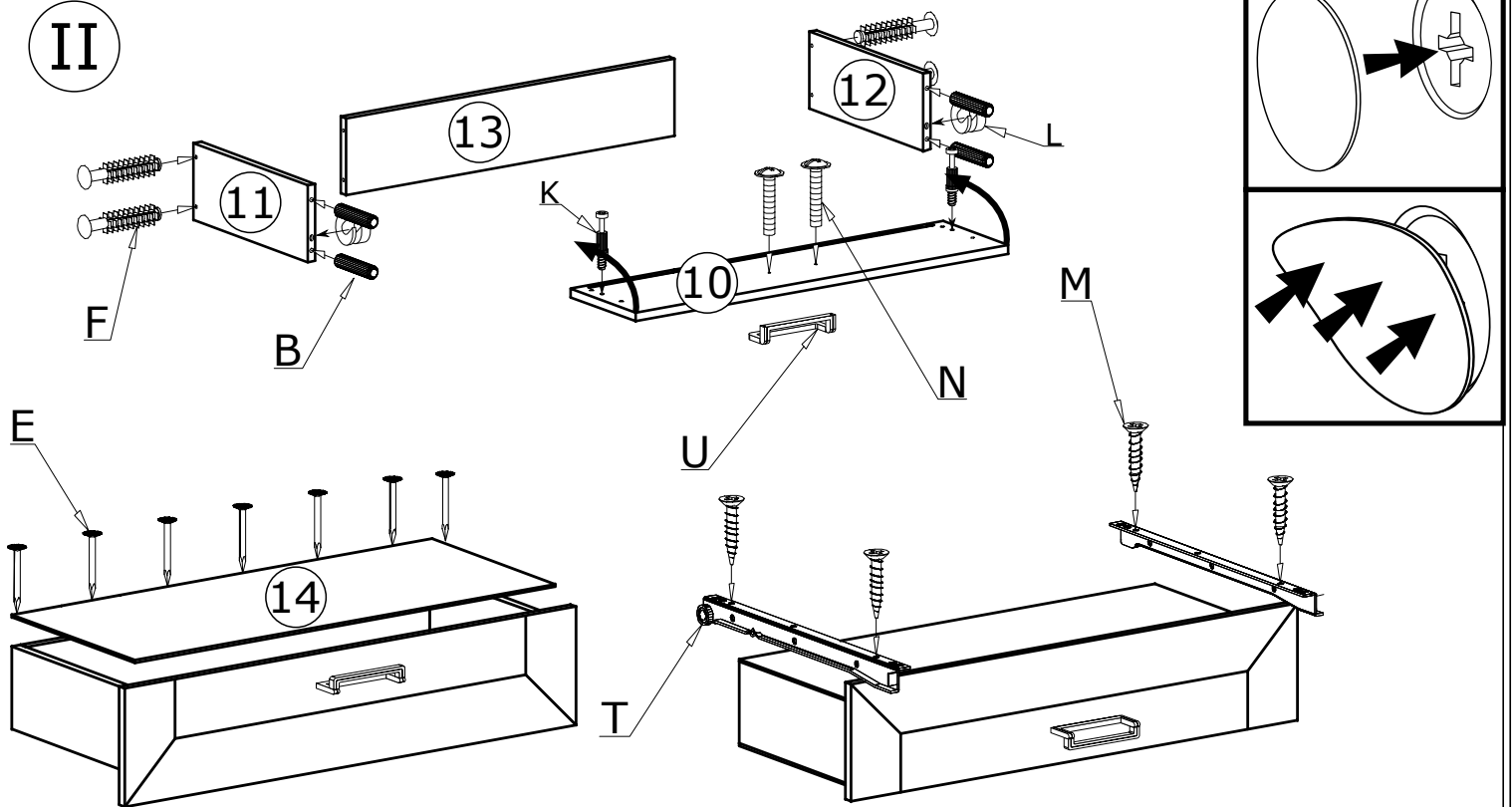

III

50X 

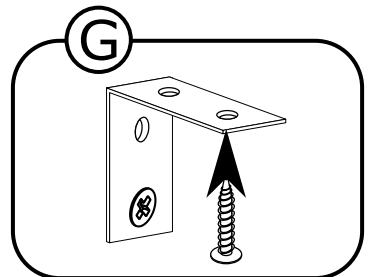
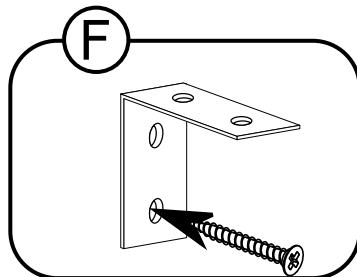
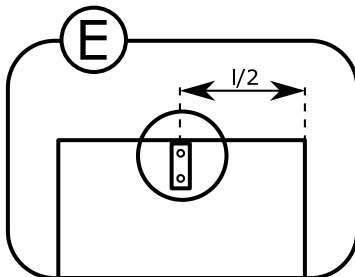
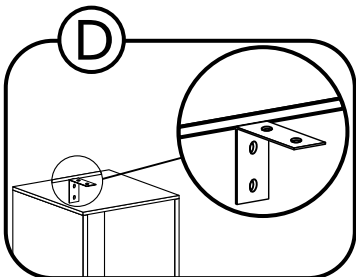
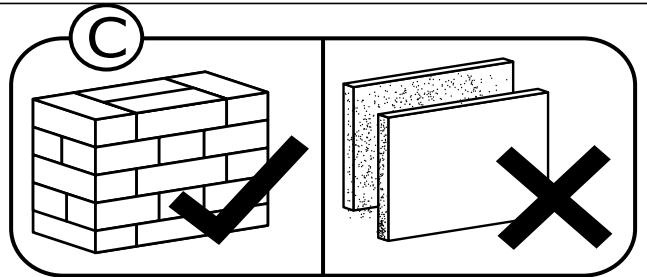
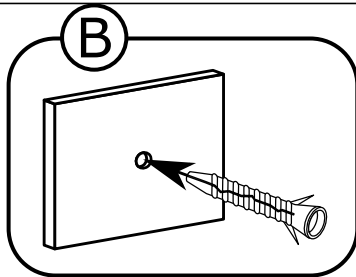
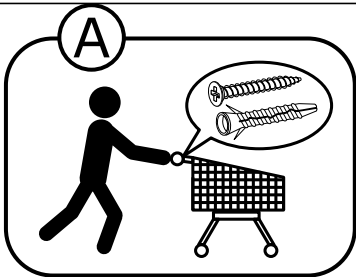
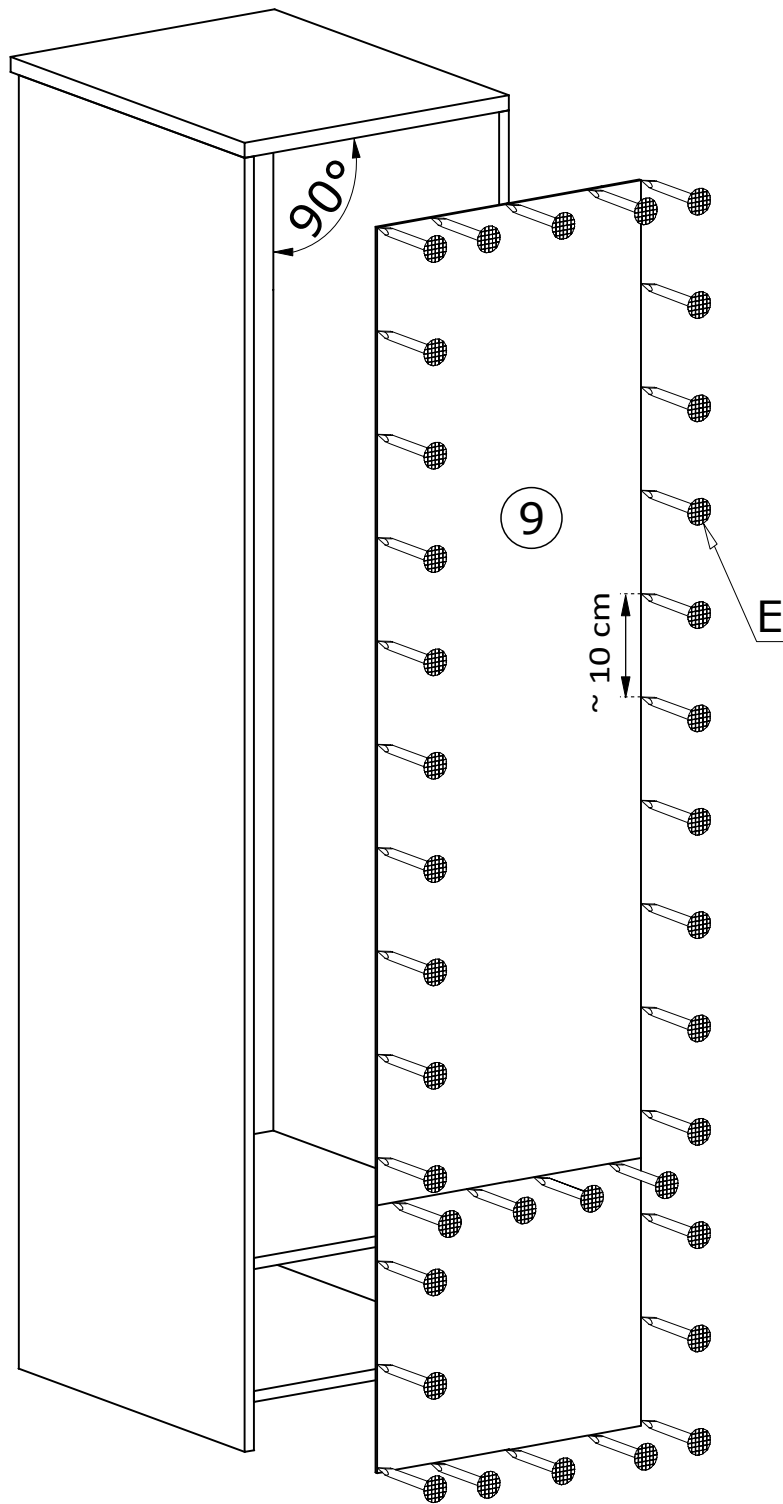

IV

