

# TITANUS 05

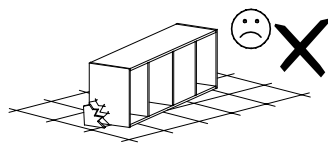

Narzędzia potrzebne do montażu

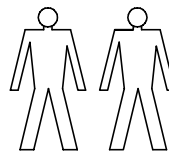

## UWAGA !!!

MONTOWANIE USZKODZONYCH  
ELEMENTÓW POWODUJE UTRATĘ  
GWARANCJI

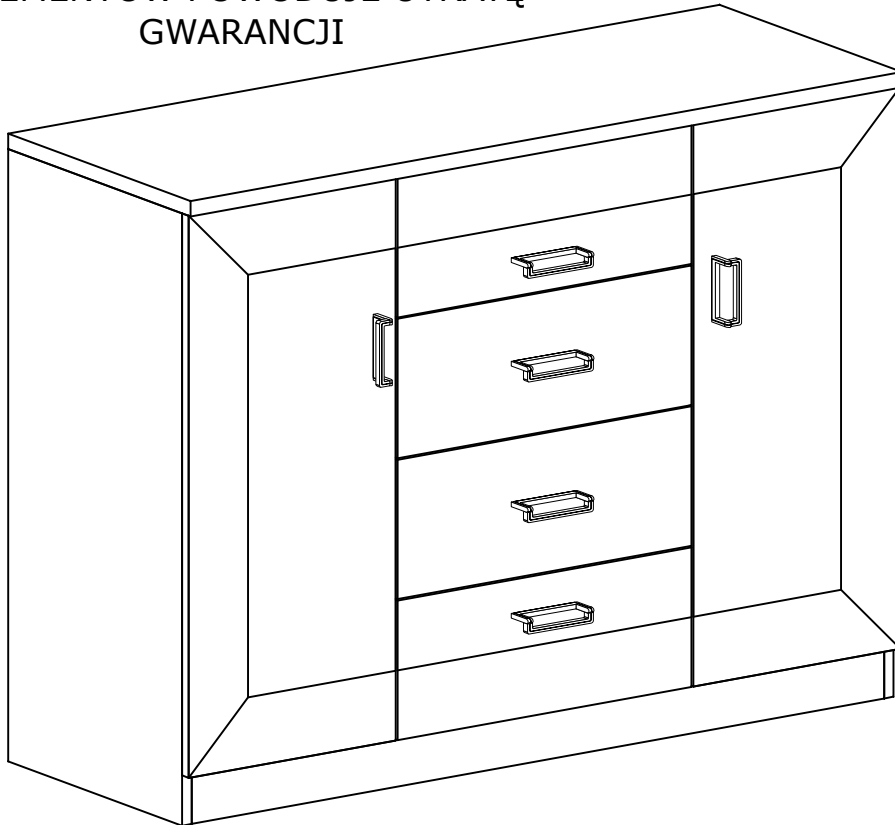

Nr	D[mm]	S[mm]	G[mm]	Ilość
1	1200	440	32	1
2	1154	405	16	1
3	770	405	16	1
4	770	405	16	1
5	865	405	16	1
6	1154	80	16	1
7	1178	810	2,5	1
8	360	150	16	4
9	400	150	16	4
10	400	150	16	4
11	437	190	16	4
12	405	388	2,5	4
13	380	350	16	2
14	777	370	16	1
15	865	405	16	1
16	777	370	16	1

W przypadku reklamacji proszę podać numer pakowacza znajdujący się na kartonie.

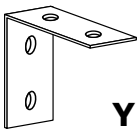

**Y - 1 St.**



**X1 - 20 St.**



**X2 - 5 St.**

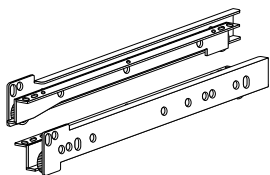

**T - 4 Kpl.**

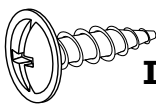

**I - 2 St.**  
3,5x16 mm

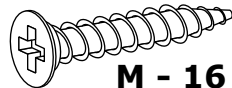

**M - 16 St.**  
4x25 mm

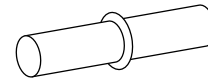

**P - 8 St.**

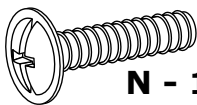

**N - 12 St.**  
4x22 mm



**U - 6 St.**

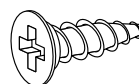

**G - 8 St.**  
3,5x16 mm

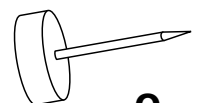

**Q - 6 St.**



**F - 16 St.**



**E - 100 St.**

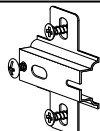

**C - 4 St.**

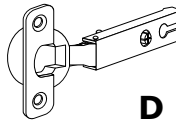

**D - 4 St.**

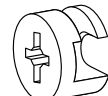

**L - 20 St.**



**R - 5 St.**

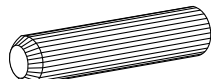

**B - 36 St.**

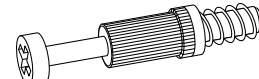

**K - 20 St.**

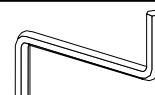

**Z - 1 St.**



**J - 16 St.**  
5x13 mm

I

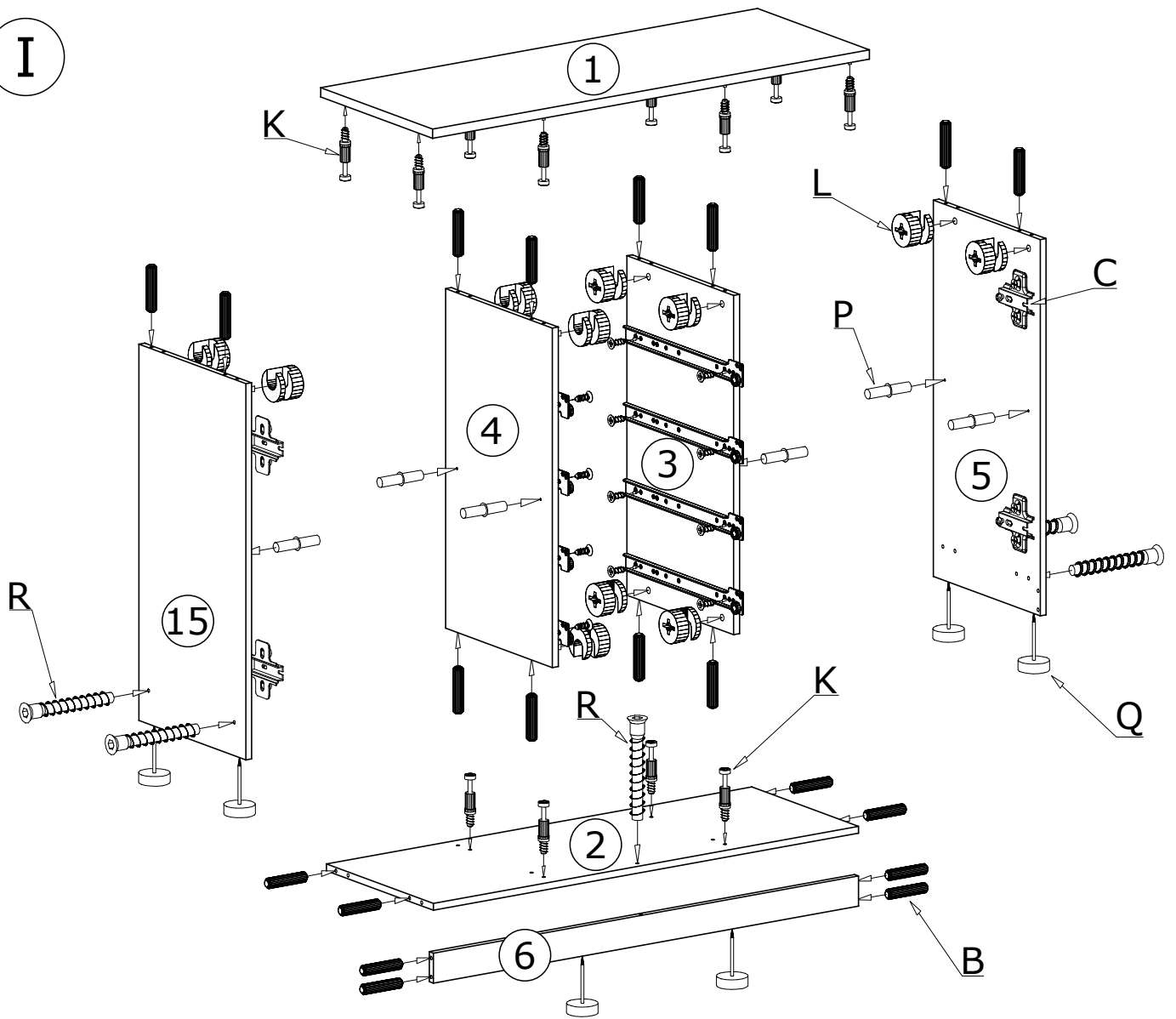

II

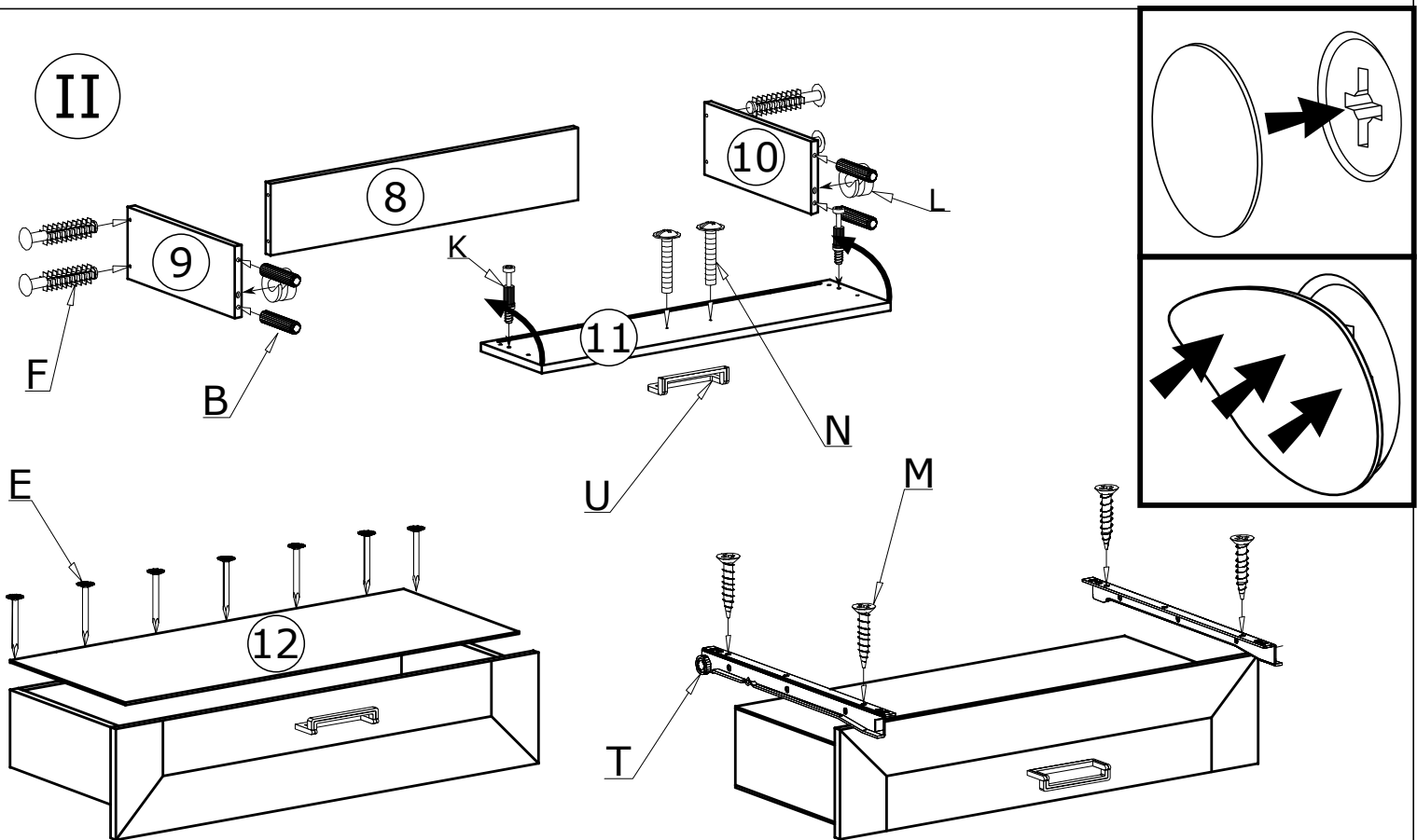

III

120X 

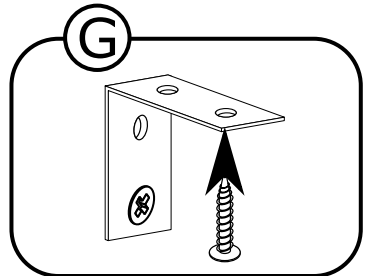
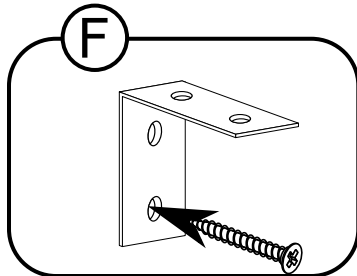
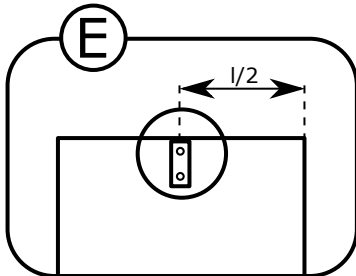
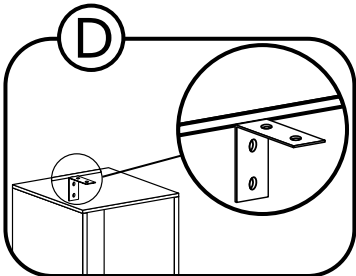
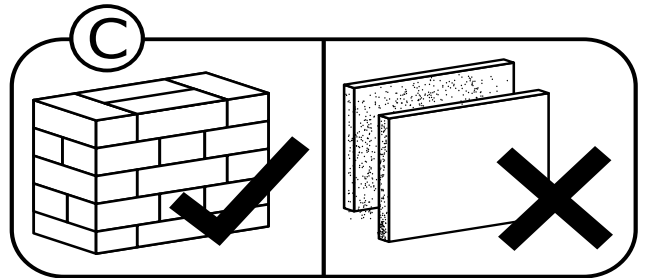
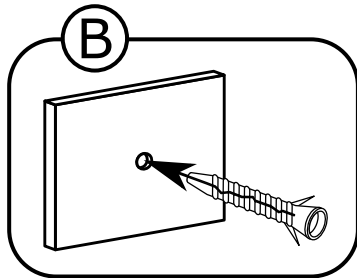
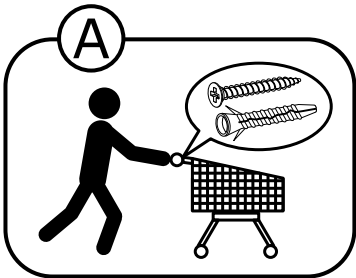
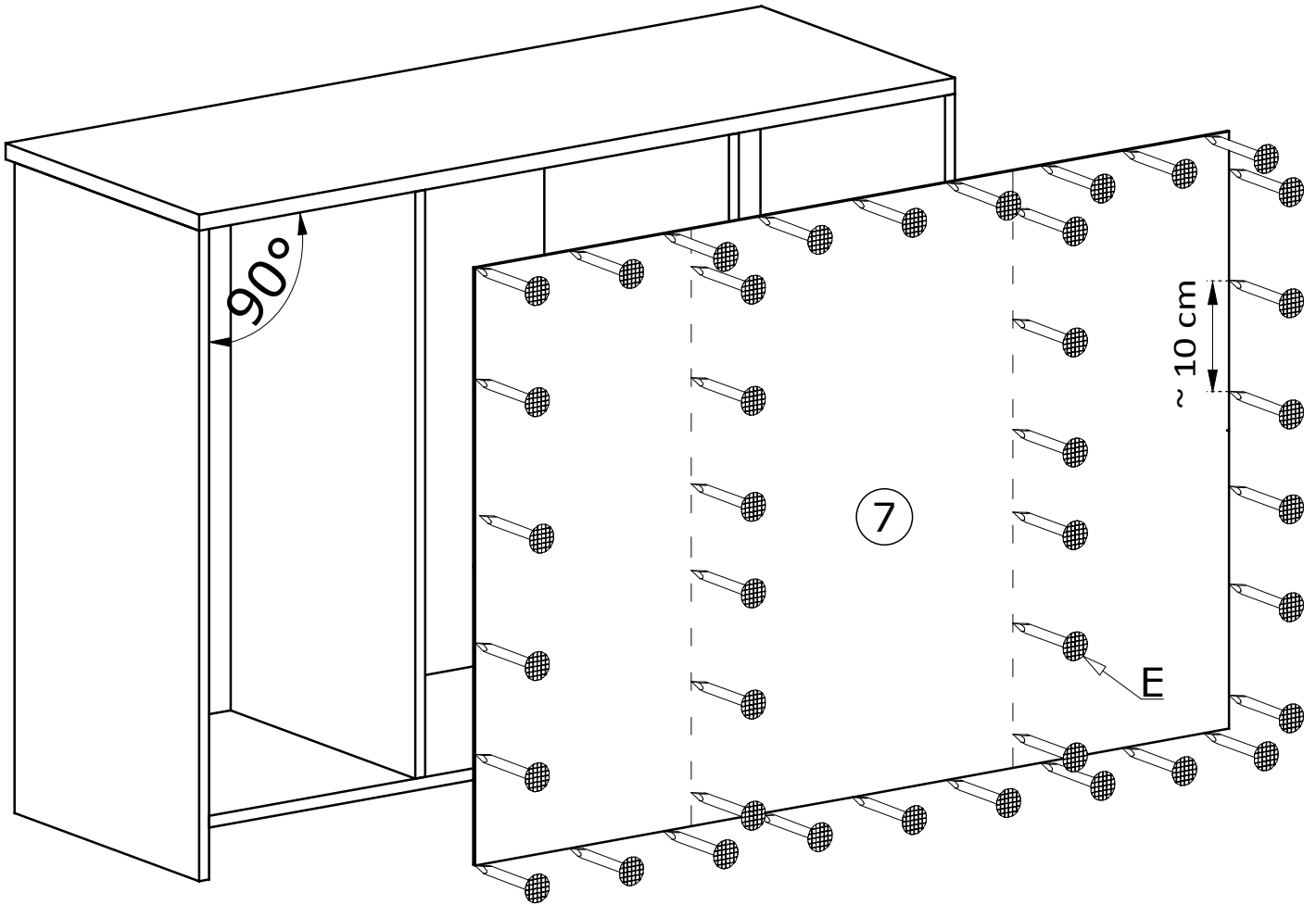

IV

