

NATURE 02

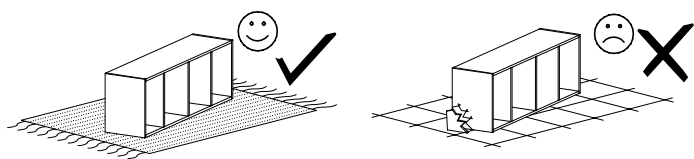

Narzędzia potrzebne do montażu

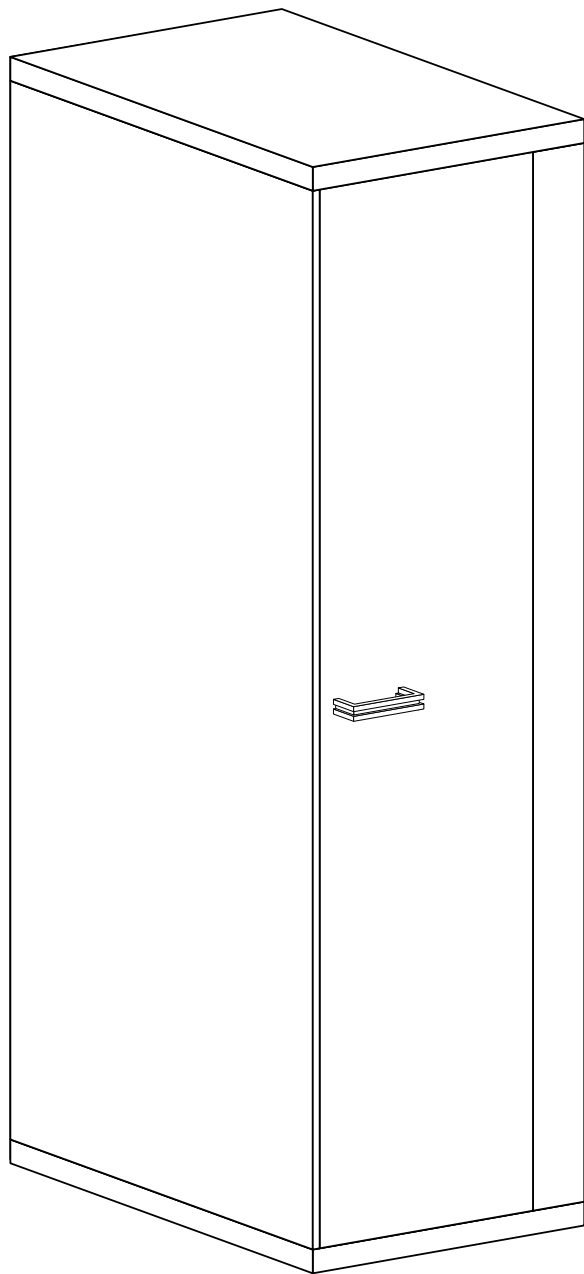
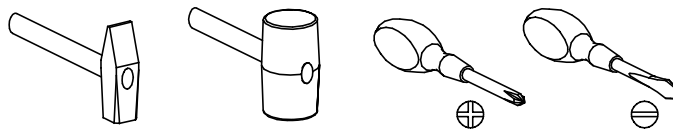

Nr	D[mm]	S[mm]	G[mm]	Ilość
1	1900	576	16	1
2	1950	560	16	1
3	578	568	48	1
4	578	568	48	1
5	560	535	16	1
6	1950	100	16	1
7	1950	560	2,5	1
8	1894	445	16	1

UWAGA !!!

MONTOWANIE USZKODZONYCH
ELEMENTÓW POWODUJE UTRATĘ
GWARANCJI

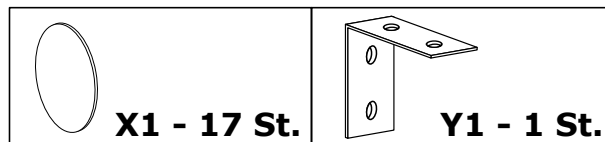

UWAGA !!!

Mebel zawiera
elementy drewniane

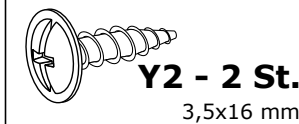

W przypadku reklamacji proszę podać numer pakowacza znajdujący się na kartonie.

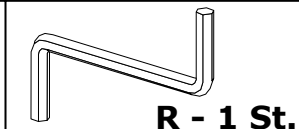
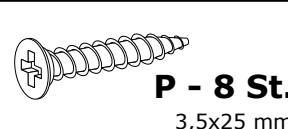
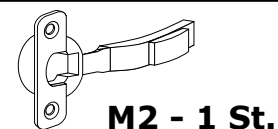
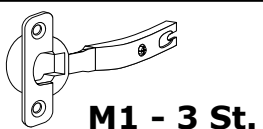
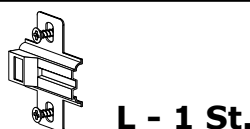
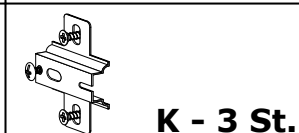
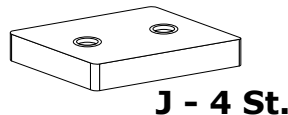
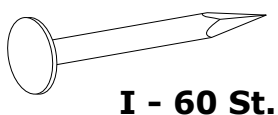
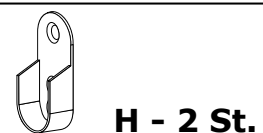
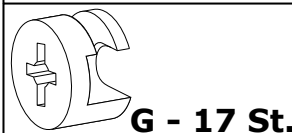
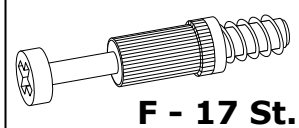
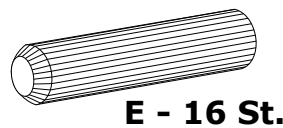
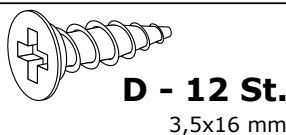
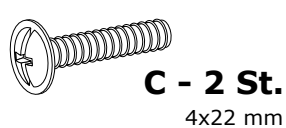
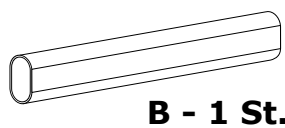
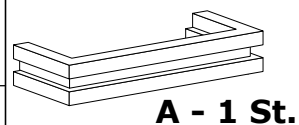

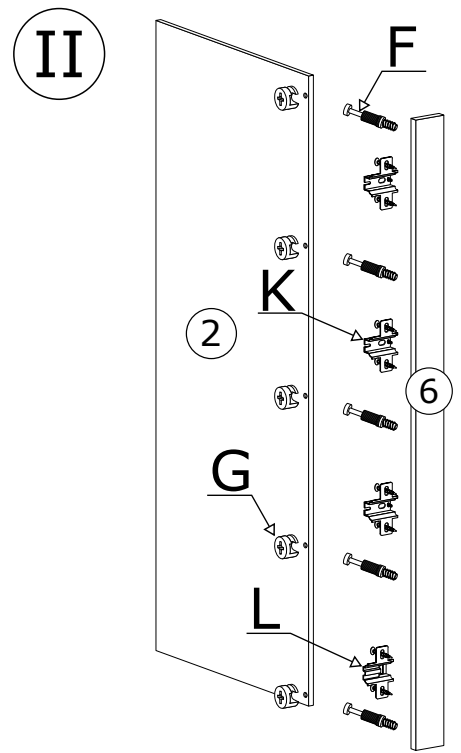
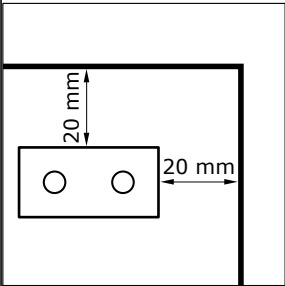
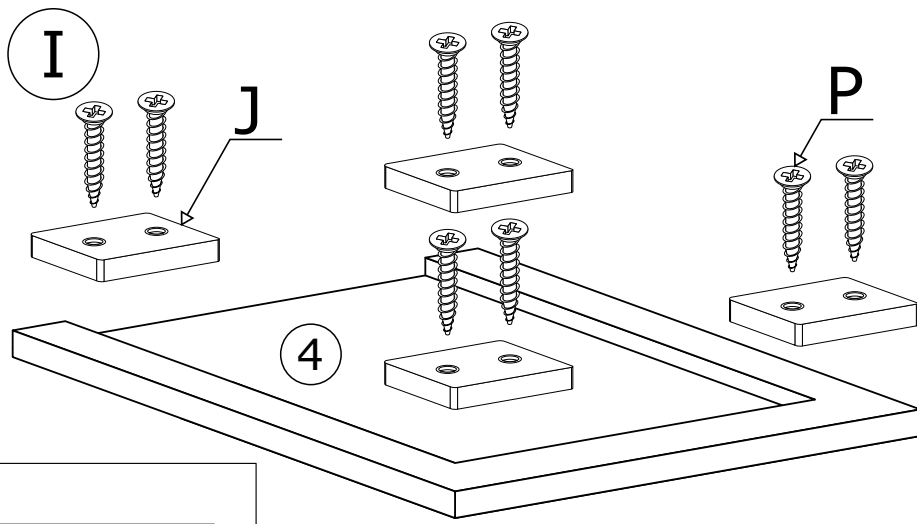

III

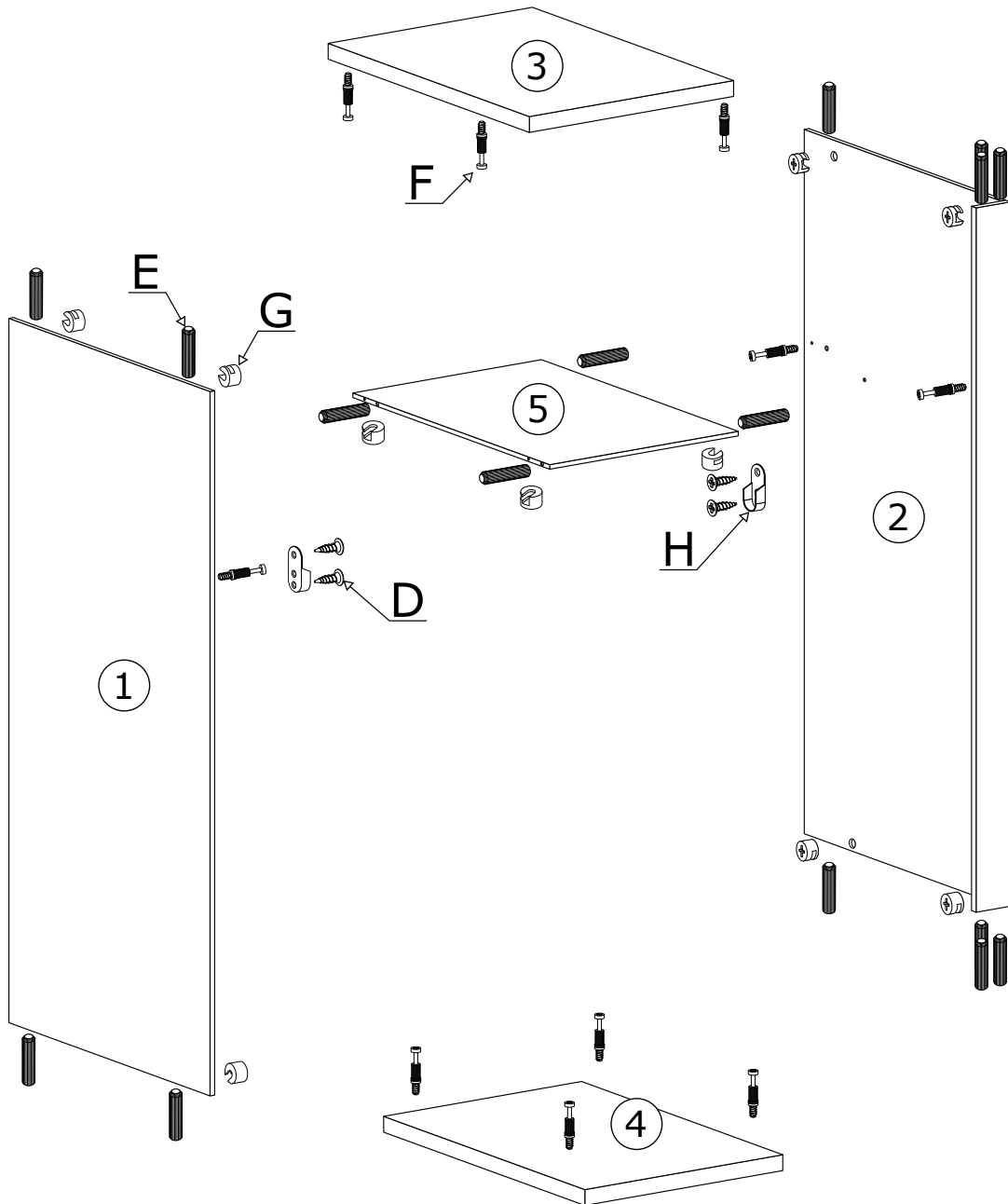

IV

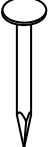
 x60

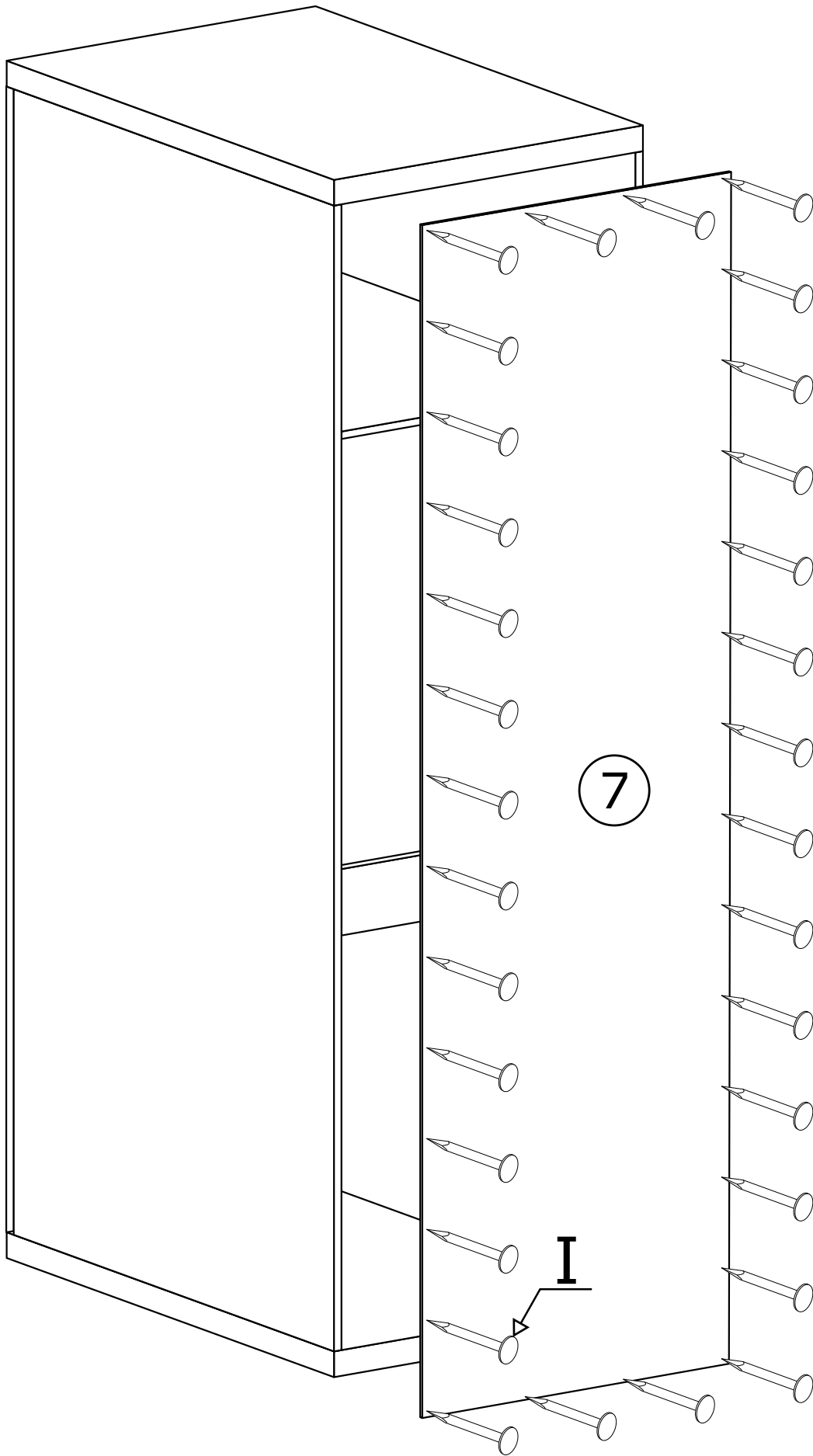

V

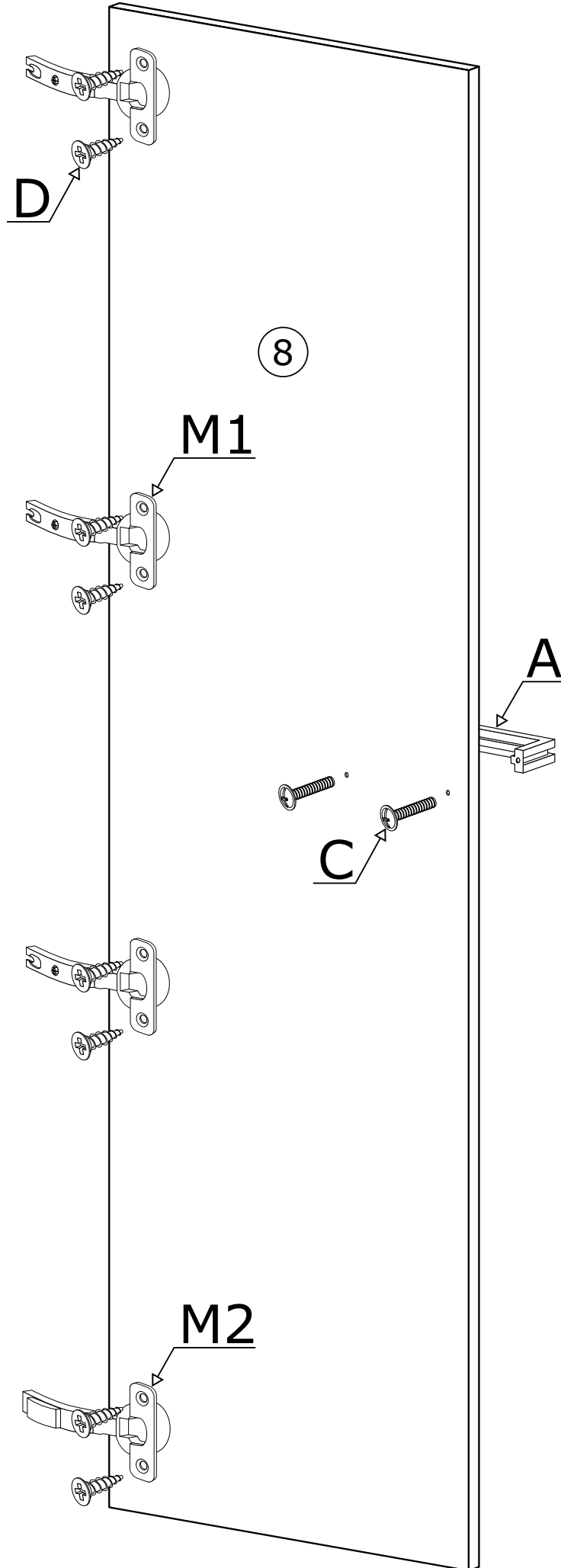

VI

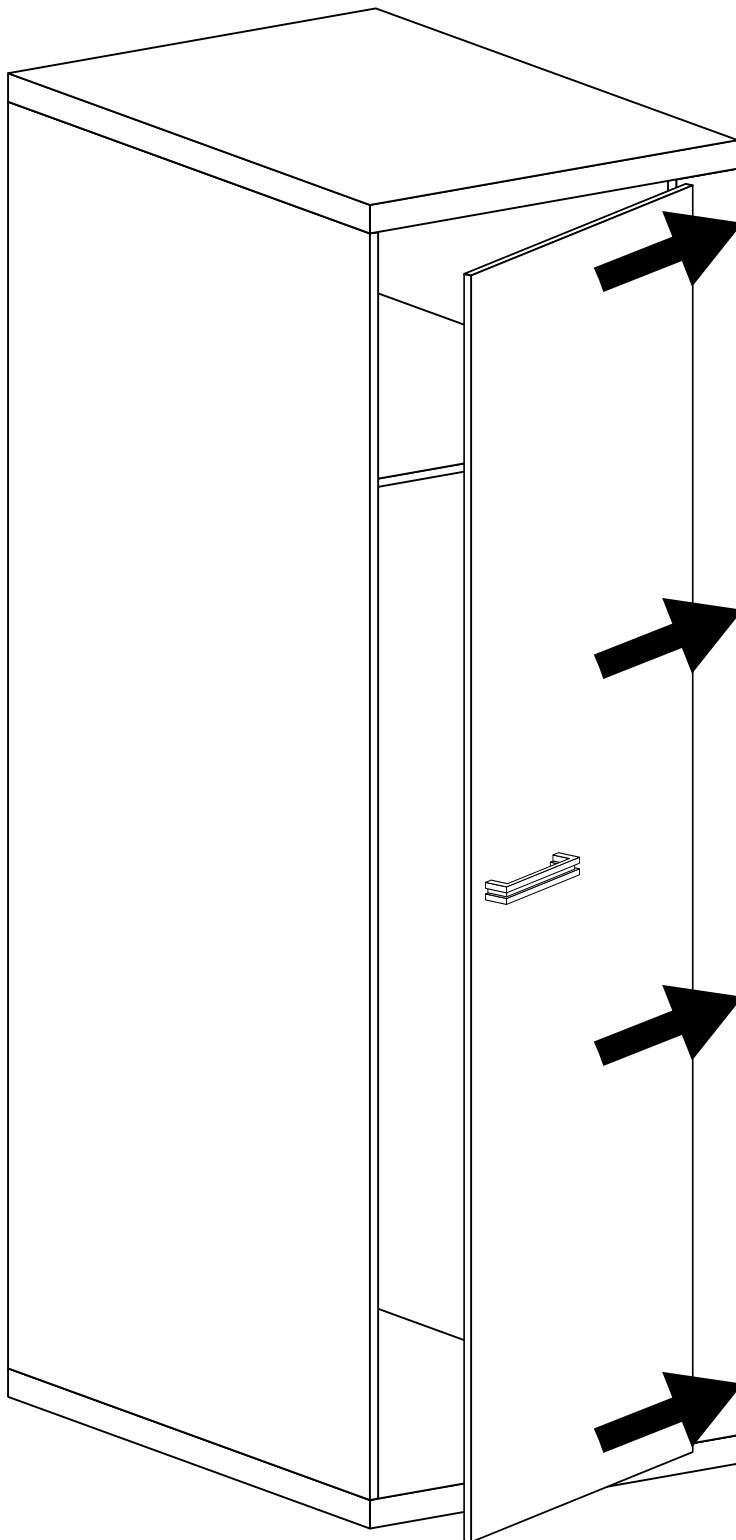
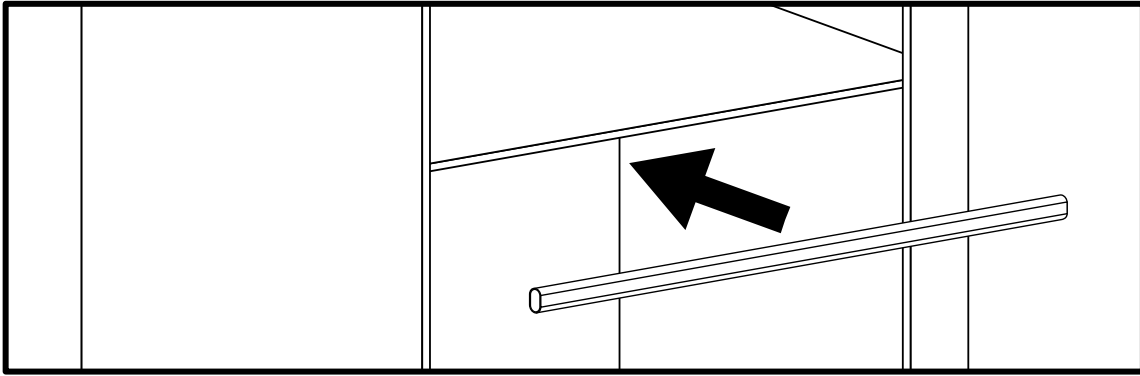

MONTAŻ KĄTOWNIKA

