

# NATURE 01

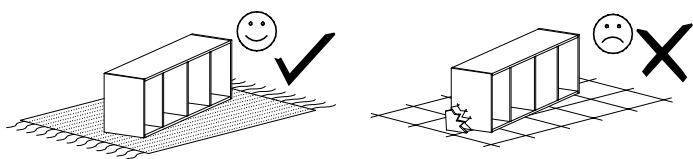

Narzędzia potrzebne do montażu

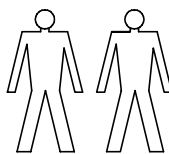
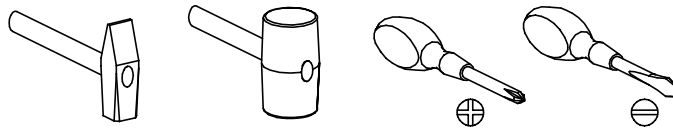

## UWAGA !!!

MONTOWANIE USZKODZONYCH  
ELEMENTÓW POWODUJE UTRATĘ  
GWARANCJI

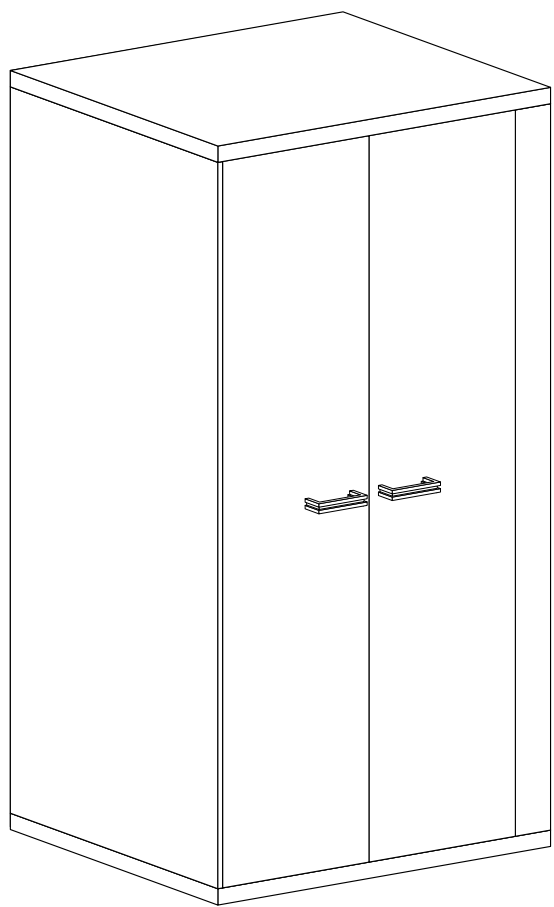

Nr	Nazwa elementu	D[mm]	S[mm]	G[mm]	Ilość
1	Bok Lewy	1900	576	16	1
2	Bok Prawy	1900	560	16	1
3	Błat Górny	1018	577	48	1
4	Błat Dolny	1018	577	48	1
5	Wieniec	983	560	16	1
6	Listwa Pionowa	1900	100	16	1
7	Listwa Tylna	983	120	16	1
8	Kapak	1950	1100	2,5	1
9	Drzwi Lewe	1894	445	16	1
10	Drzwi Prawe	1894	445	16	1

## UWAGA !!!

Mebel zawiera  
elementy drewniane

W przypadku reklamacji proszę podać numer pakowacza znajdujący się na kartonie.

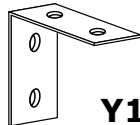

**Y1 - 1 St.**

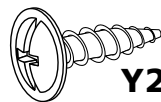

**Y2 - 2 St.**  
3,5x16 mm



**X1 - 21 St.**



**X2 - 4 St.**  
ø8 mm



**X3 - 4 St.**  
ø5 mm

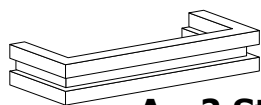

**A - 2 St.**

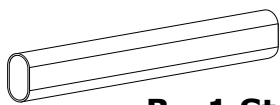

**B - 1 St.**

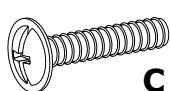

**C - 4 St.**  
4x22 mm

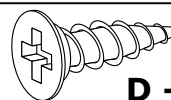

**D - 28 St.**  
3,5x16 mm

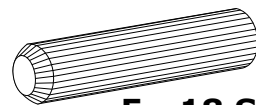

**E - 18 St.**

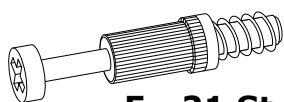

**F - 21 St.**

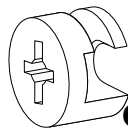

**G - 21 St.**

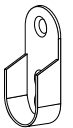

**H - 2 St.**

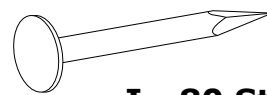

**I - 80 St.**

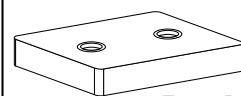

**J - 4 St.**

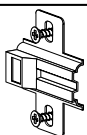

**L - 8 St.**

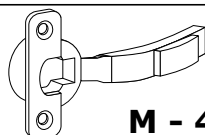

**M - 4 St.**

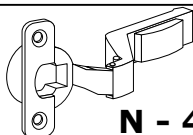

**N - 4 St.**

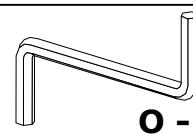

**O - 1 St.**

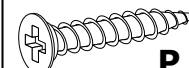

**P - 8 St.**  
3,5x25 mm

I

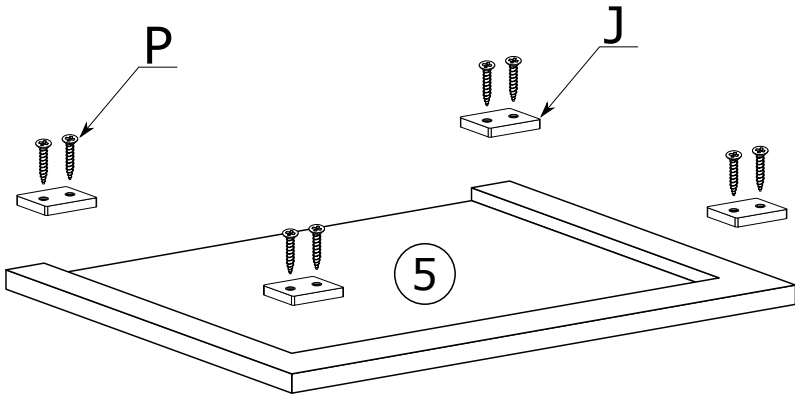

II

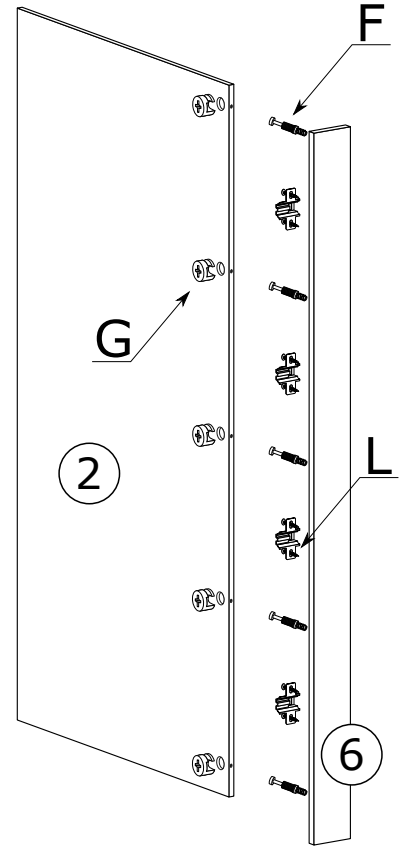

III

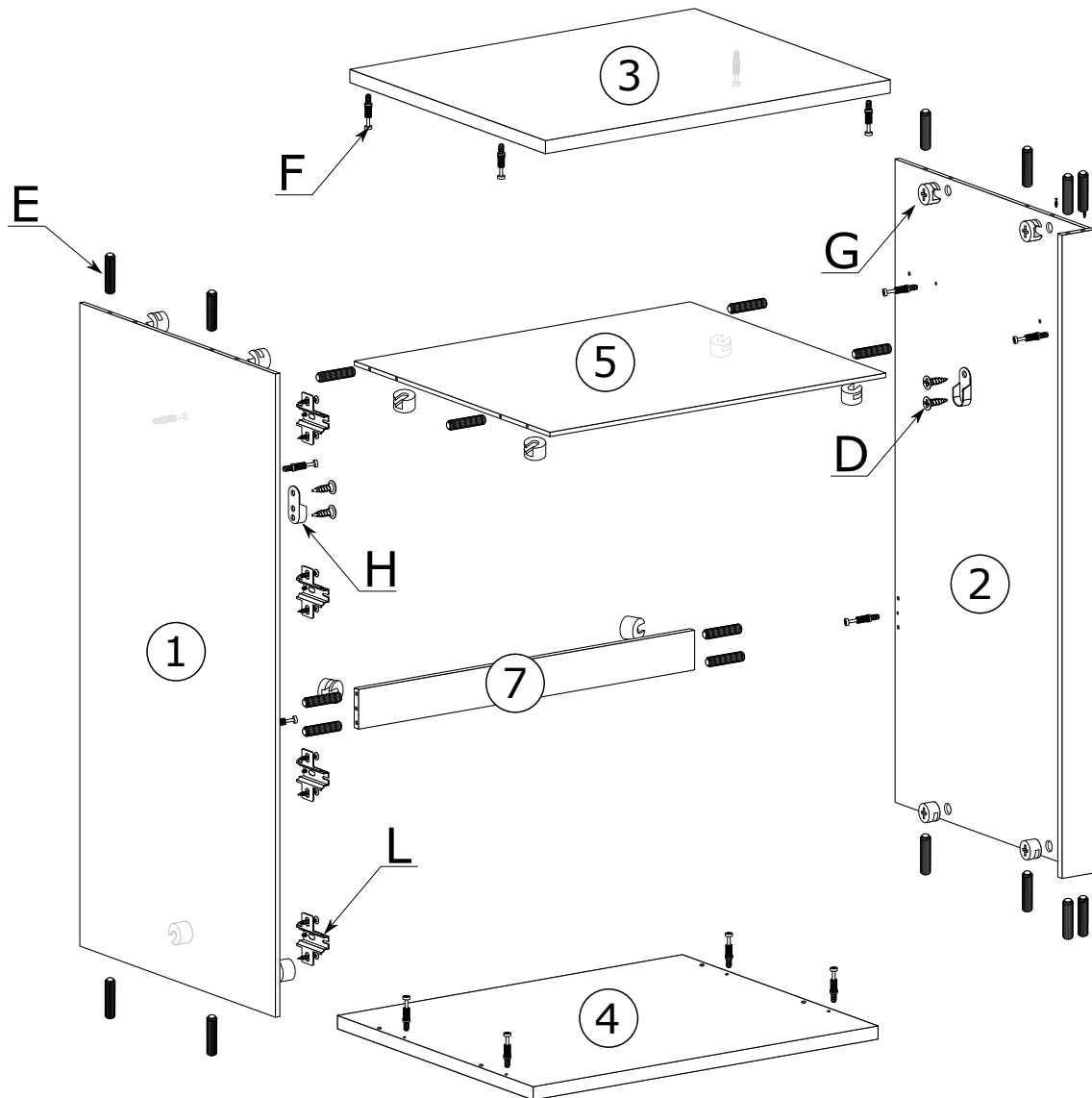

IV

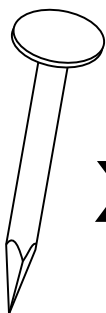
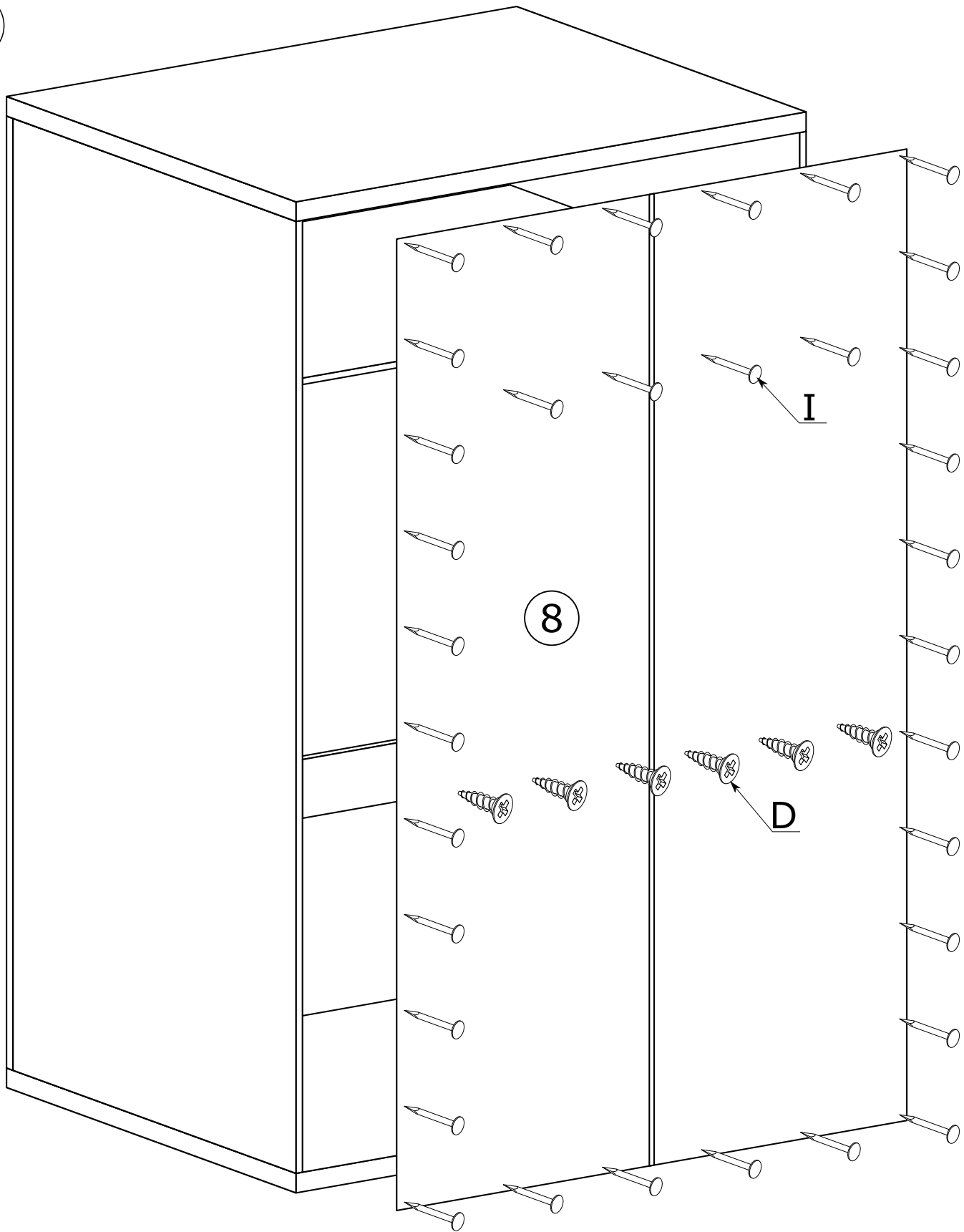

x80

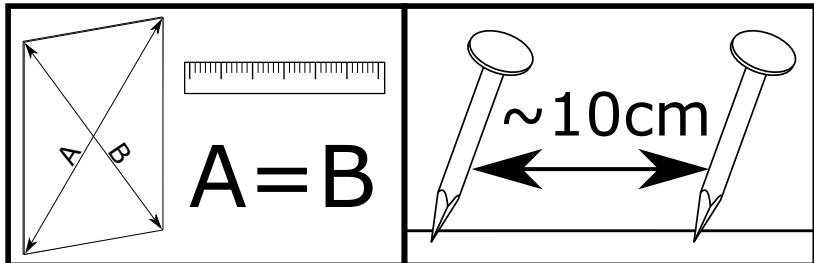

V

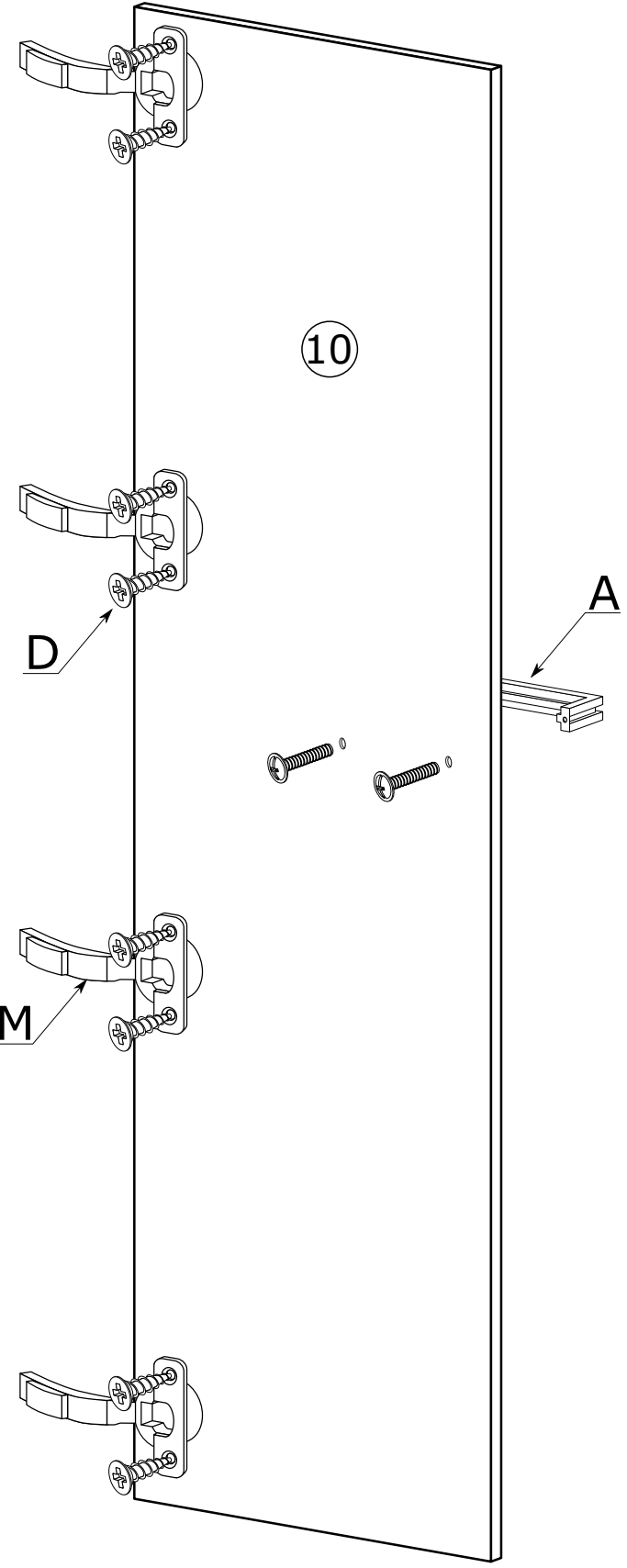
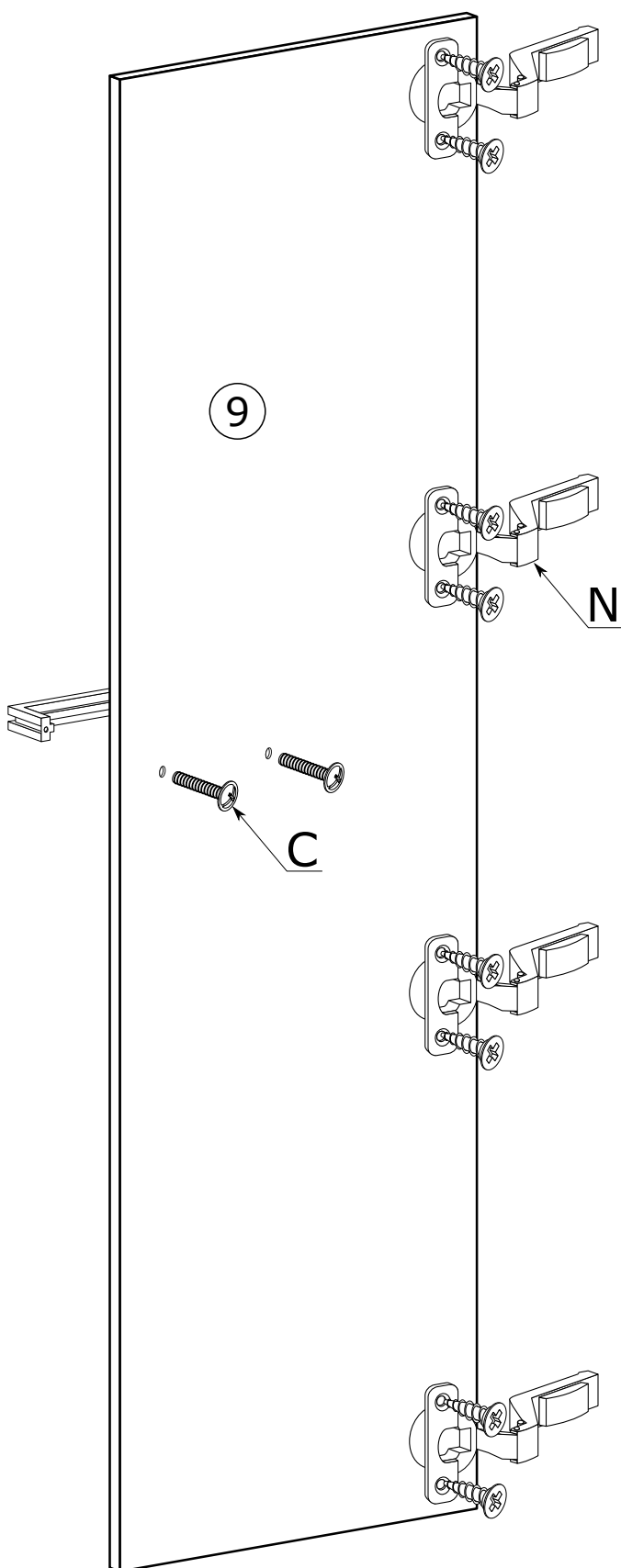

VI

