

# LIVIA 02

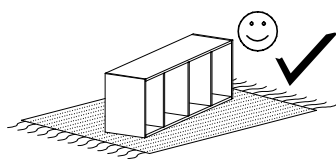

## Narzędzia potrzebne do montażu

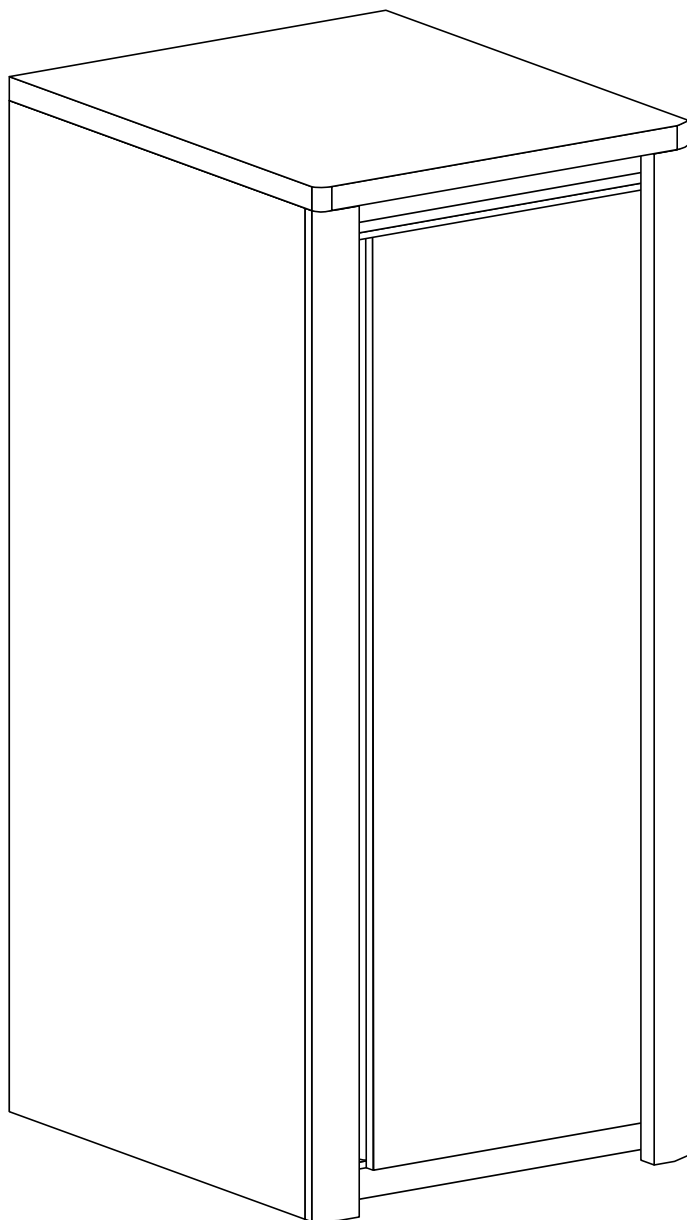
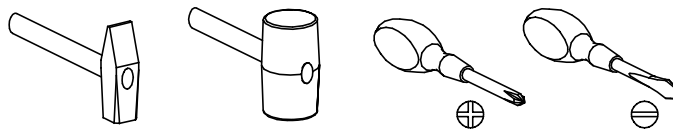

Nr	Nazwa elementu	D[mm]	S[mm]	G[mm]	Ilość
1	Bok P/L	1916	557	16	2
2	Błat Górny	726	587	48	1
3	Wieniec G/D	691	557	16	2
4	Cokół	691	80	16	2
5	Listwa Górna	691	54	16	1
6	Listwa MDF P/L	1916	80	28	2
7	Listwa MDF	1750	70	28	1
8	Kapak	1880	358	2,5	2
9	Drzwi	1795	532	16	1

### **UWAGA !!!**

MONTOWANIE USZKODZONYCH  
ELEMENTÓW POWODUJE UTRATĘ  
GWARANCJI

W przypadku reklamacji proszę podać numer pakowacza znajdujący się na kartonie.



**X2 - 6 St.**

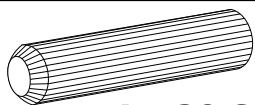

**A - 30 St.**

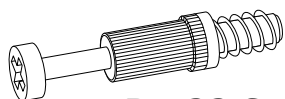

**B - 22 St.**

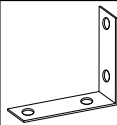

**Y1 - 1 St.**

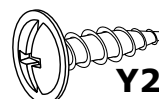

**Y2 - 2 St.**  
3,5x16 mm



**X1 - 22 St.**

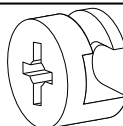

**C - 22 St.**

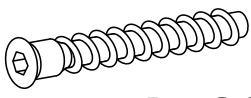

**D - 6 St.**

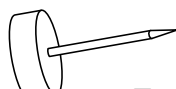

**E - 4 St.**

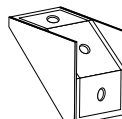

**F - 4 St.**

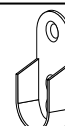

**H - 2 St.**



**I - 50 St.**

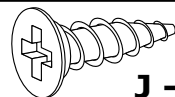

**J - 20 St.**  
3,5x16 mm

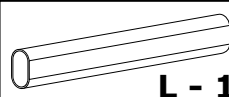

**L - 1 St.**  
638 mm

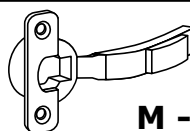

**M - 4 St.**

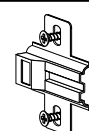

**N - 4 St.**

I

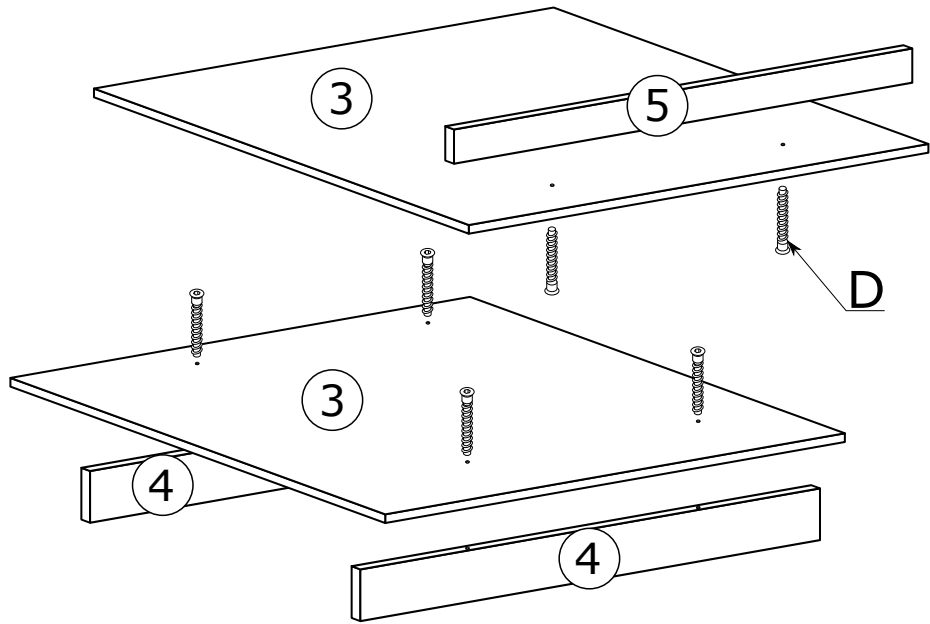

II

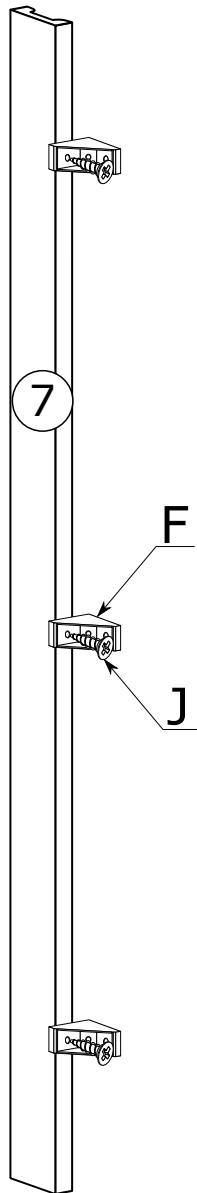

III

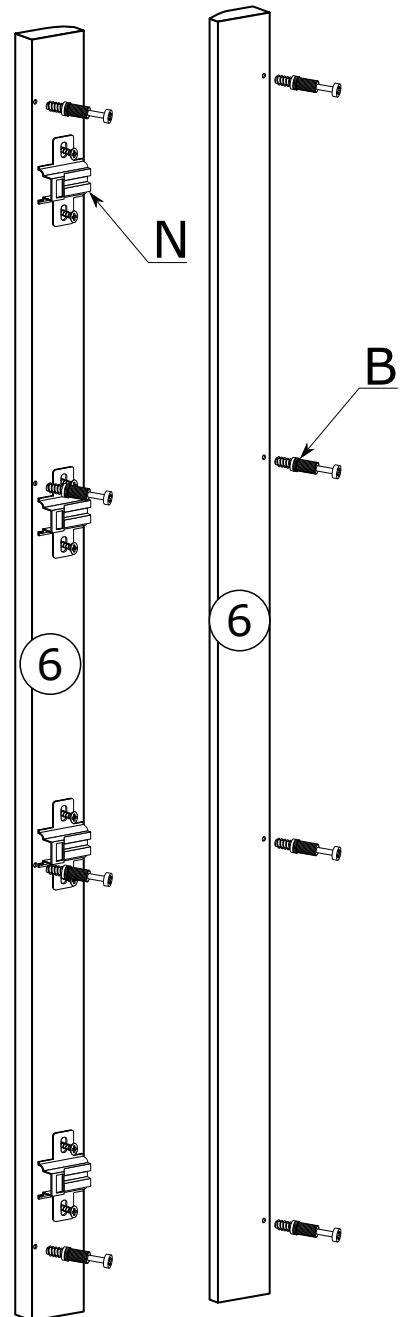

IV

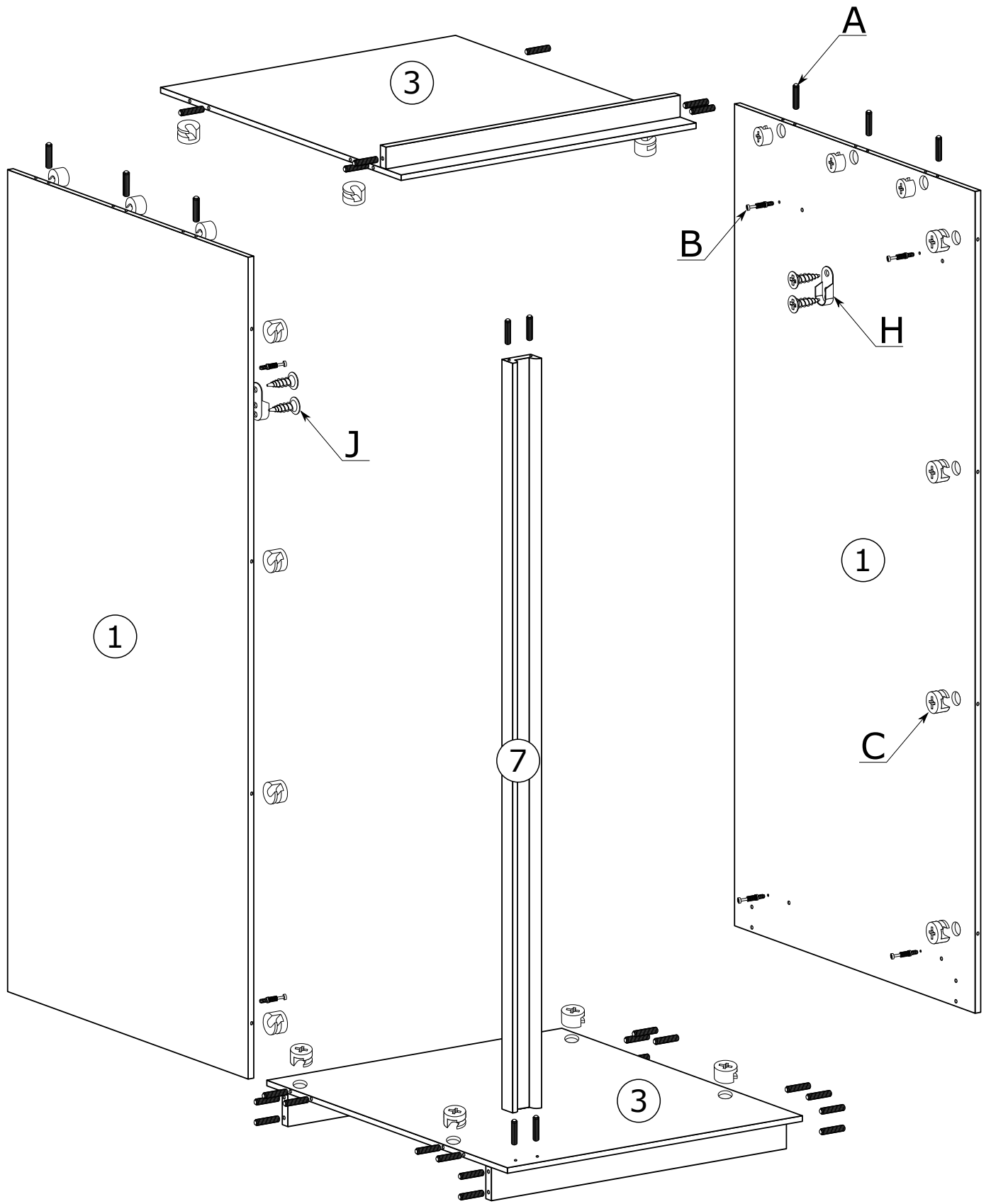

V

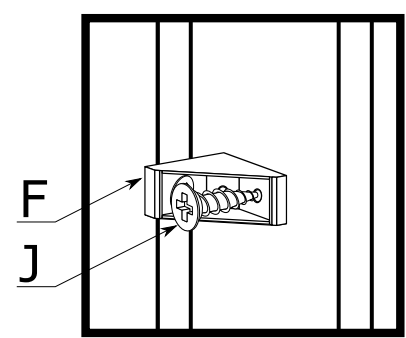
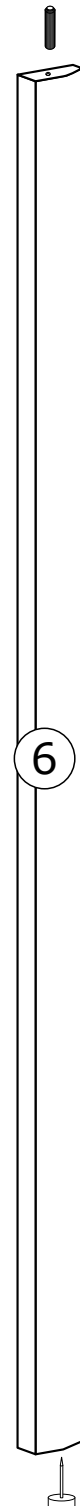
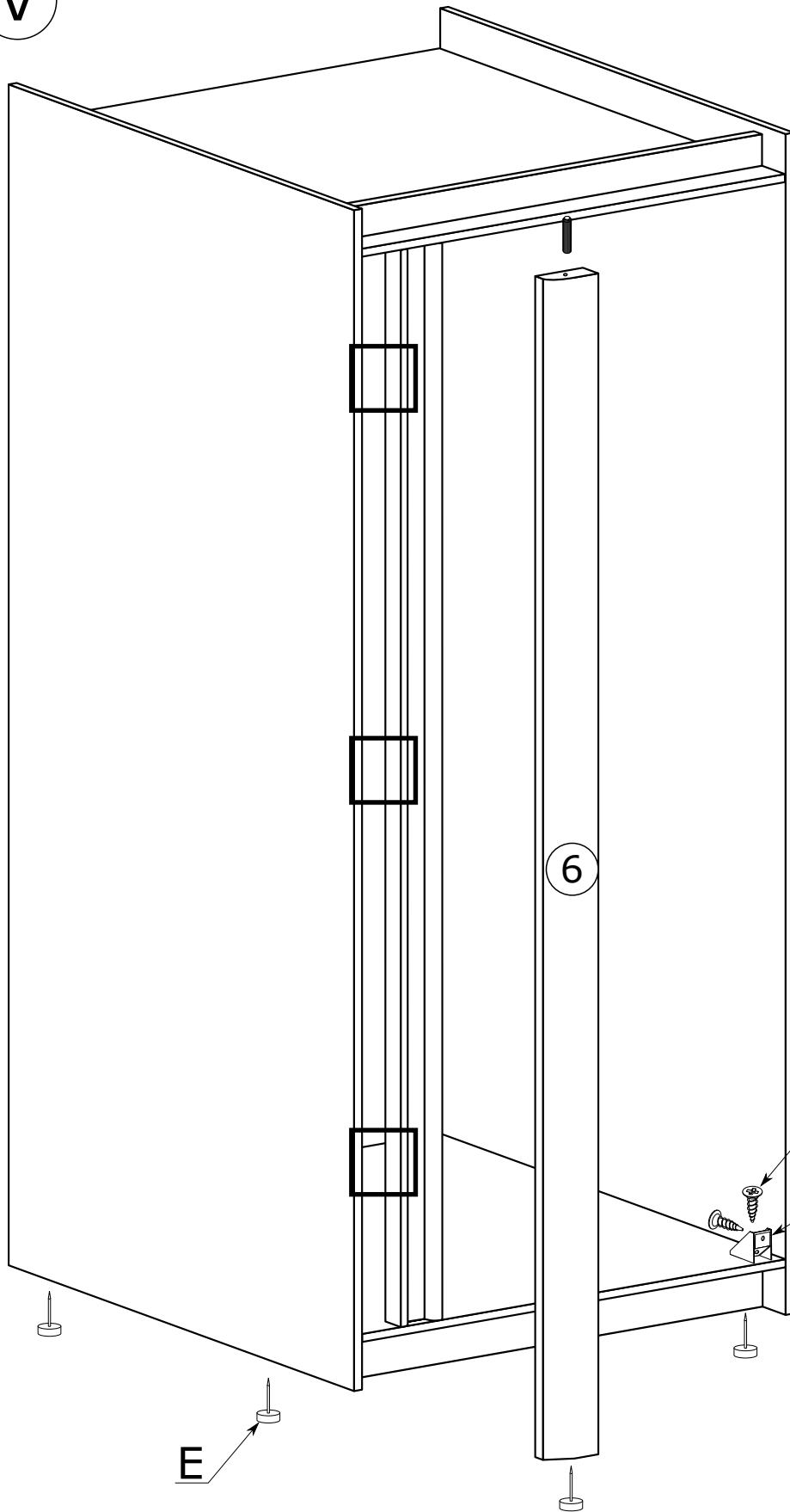

VI

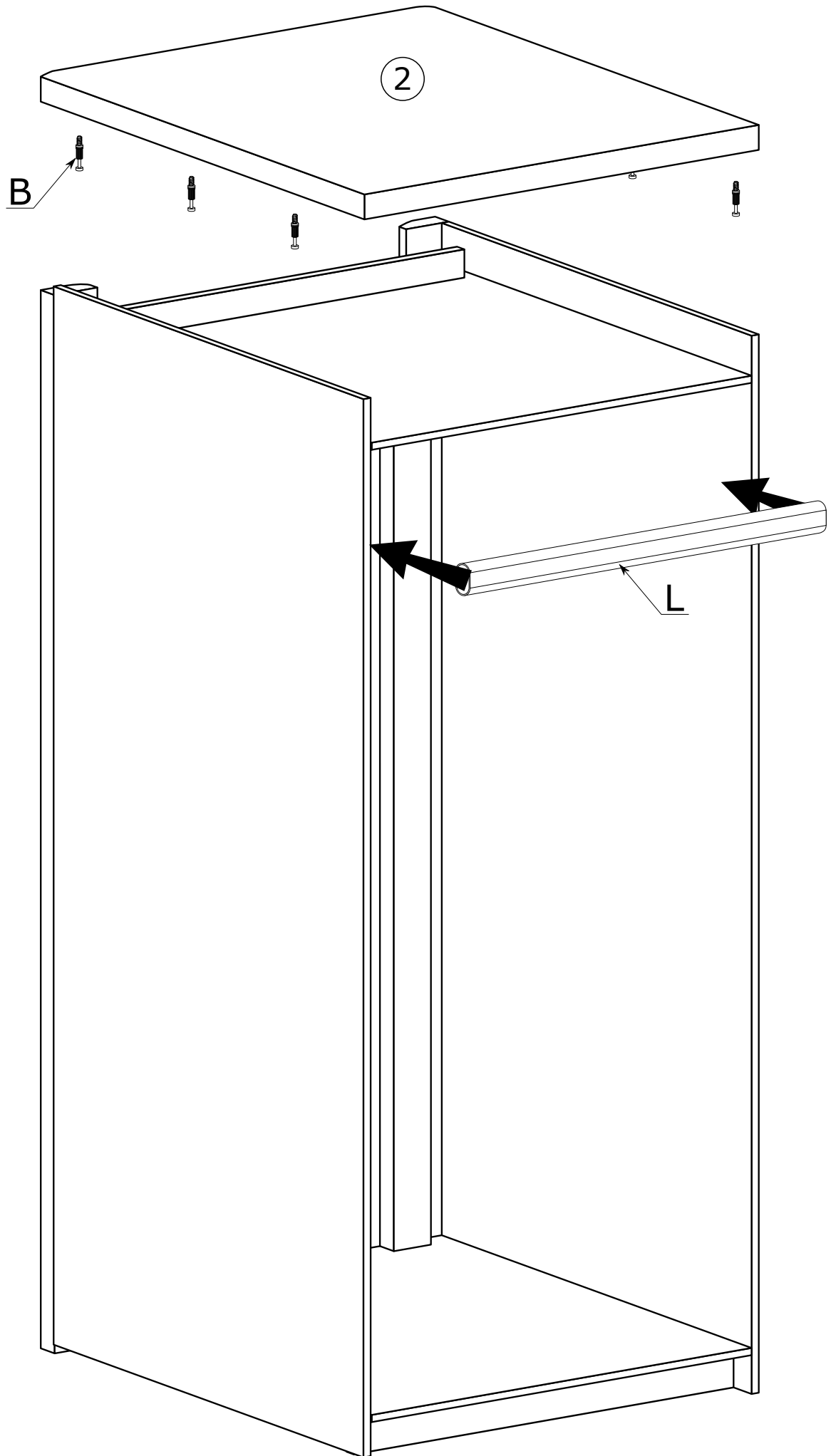

VII

x50

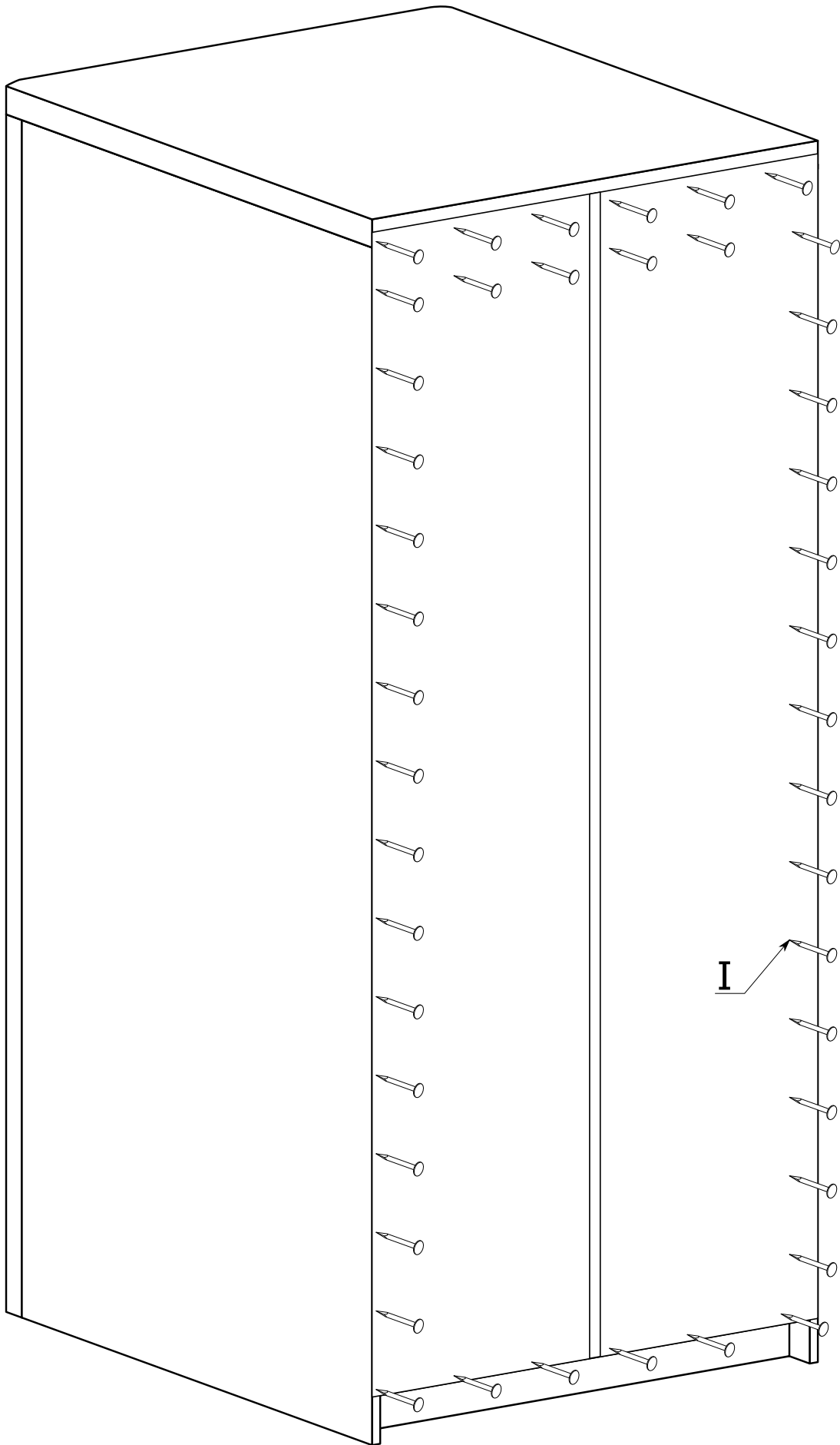
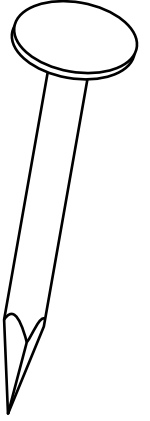

$A = B$

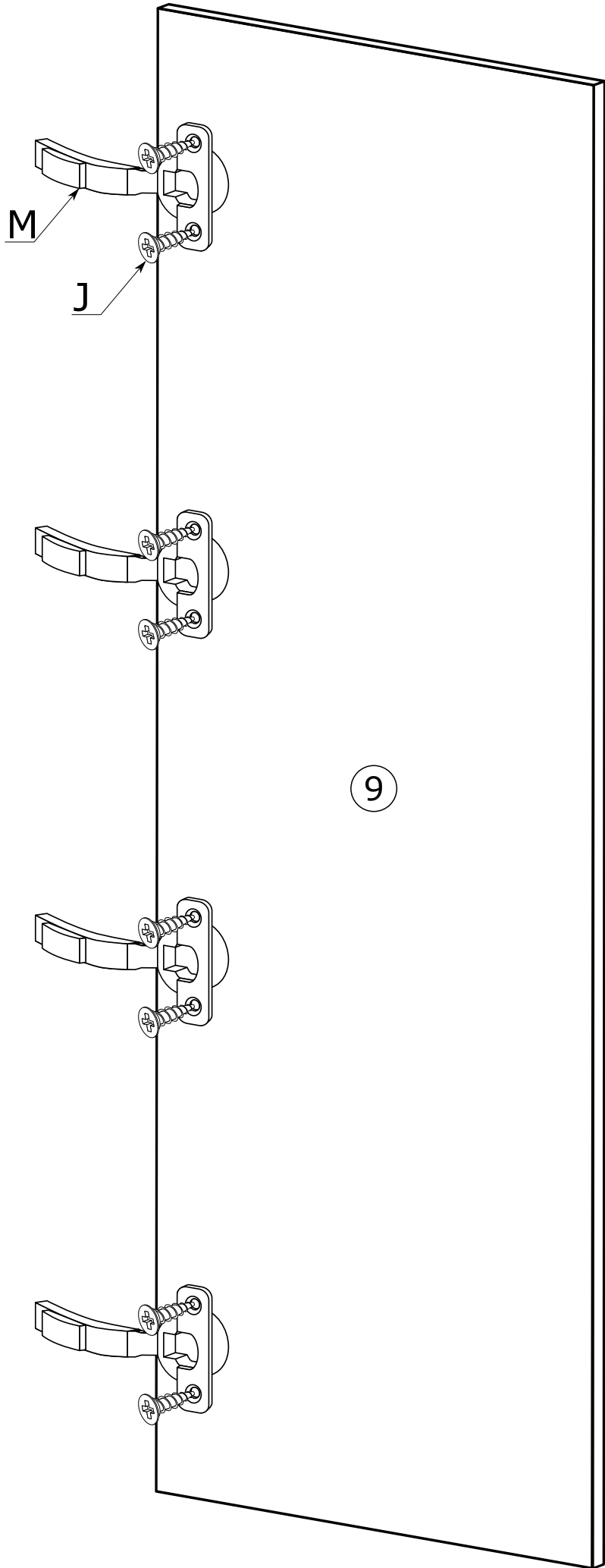

IX

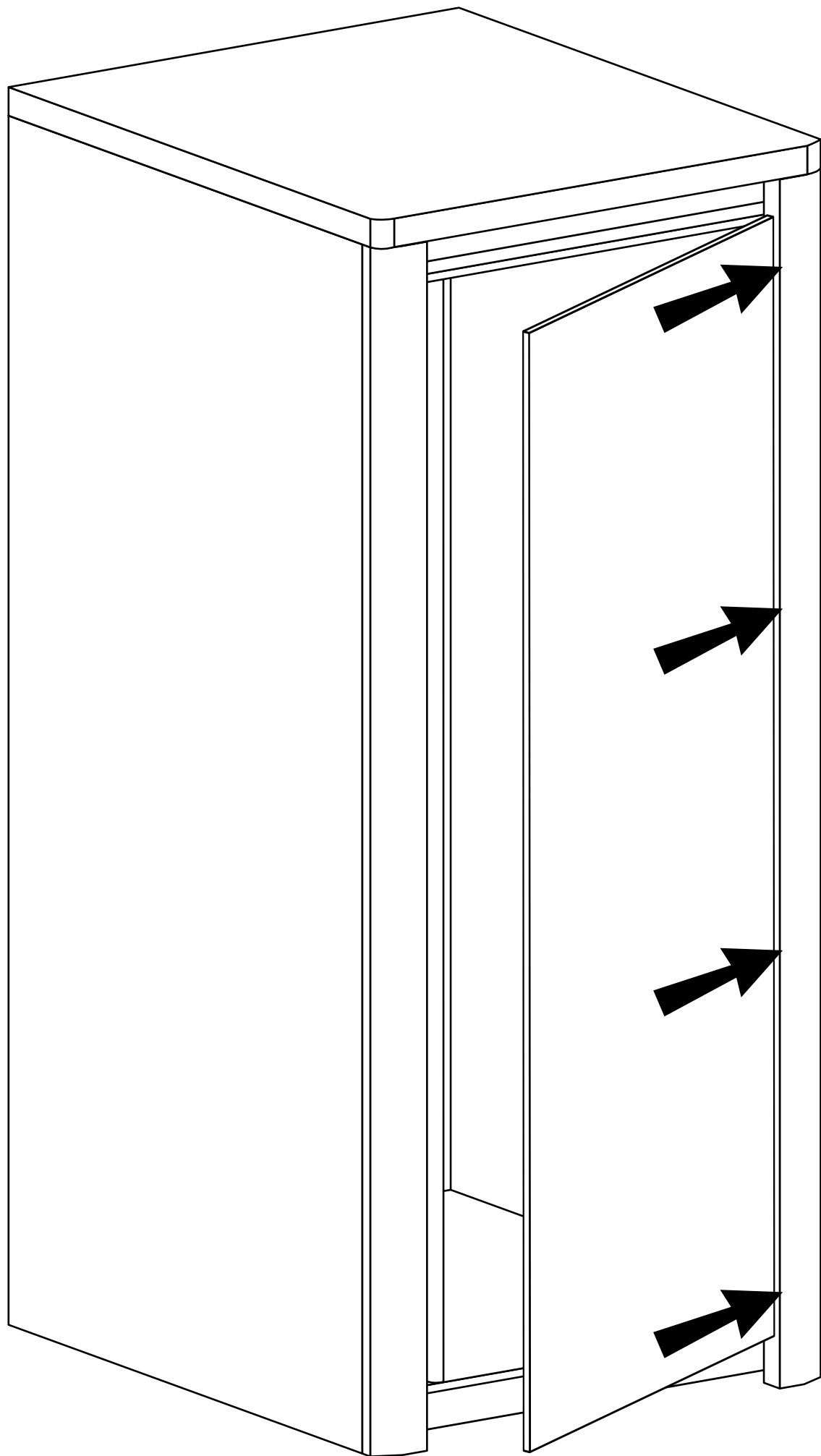



# MONTAŻ KĄTOWNIKA

