

# KENNY 08

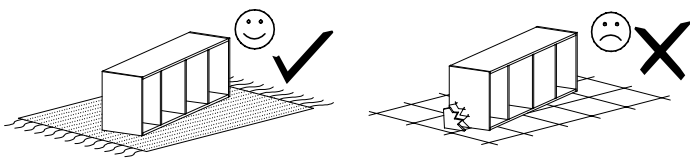

Narzędzia potrzebne do montażu

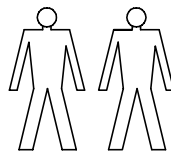
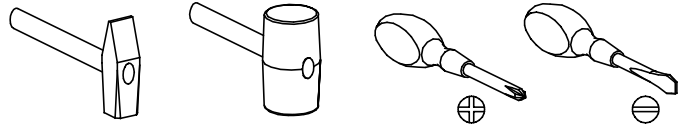

## **UWAGA !!!**

MONTOWANIE USZKODZONYCH  
ELEMENTÓW POWODUJE UTRATĘ  
GWARANCJI

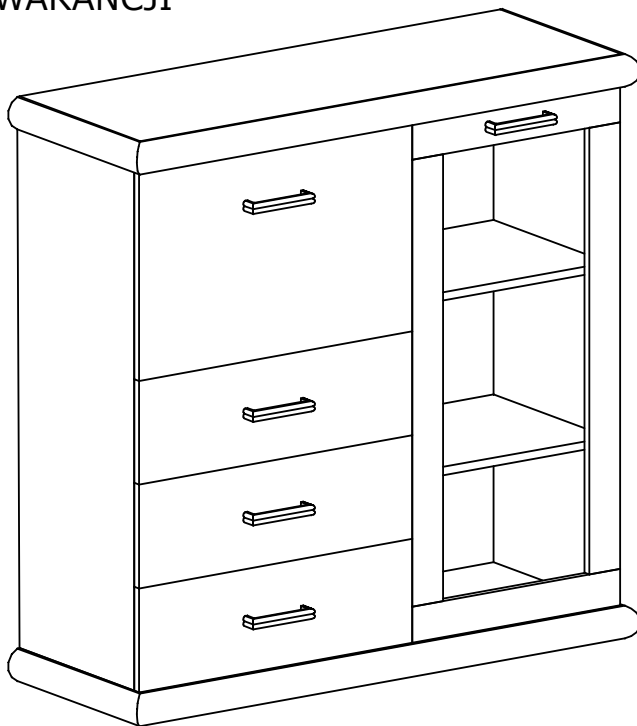

Nr	D[mm]	S[mm]	G[mm]	Ilość
1	1155	450	65	1
2	1155	450	65	1
3	1020	410	16	1
4	1020	410	16	1
5	1020	410	16	1
6	635	380	16	1
7	1045	450	2,5	1
8	1045	636	2,5	1
9	432	380	16	2
10	961	450	16	1
11	590	355	2,5	3
12	635	190	16	3
13	350	150	16	3
14	350	150	16	3
15	560	150	16	3
16	617	410	16	1

## **UWAGA !!!**

Mebel zawiera  
elementy drewniane

W przypadku reklamacji proszę podać numer pakowacza znajdujący się na kartonie.

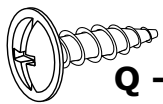

**Q - 2 St.**  
3,5x16 mm

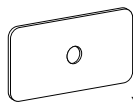

**Y - 8 St.**



**X1 - 6 St.**



**X2 - 4 St.**

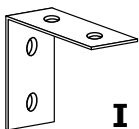

**I - 1 St.**

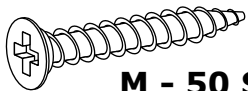

**M - 50 St.**  
3x30 mm

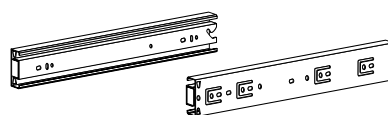

**T - 3 Kpl.**

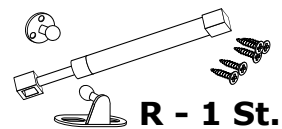

**R - 1 St.**

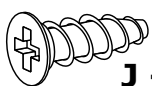

**J - 24 St.**  
5x13 mm

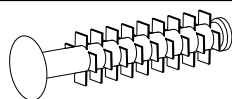

**P - 12 St.**



**A1 - 4 St.**  
7x50 mm

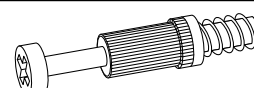

**K - 18 St.**



**L - 18 St.**

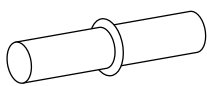

**S - 8 St.**

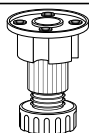

**F - 5 St.**



**U - 5 St.**

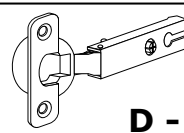

**D - 4 St.**

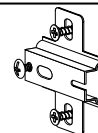

**C - 4 St.**



**E - 70 St.**

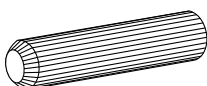

**B - 24 St.**

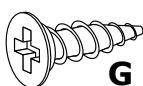

**G - 36 St.**  
3,5x16 mm

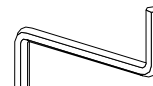

**Z - 1 St.**

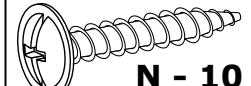

**N - 10 St.**  
4x27 mm



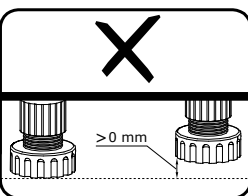
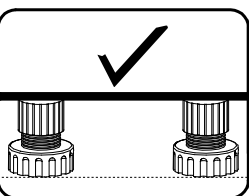
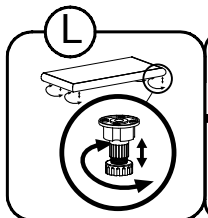
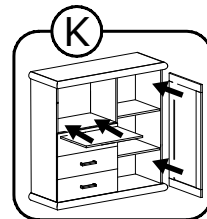
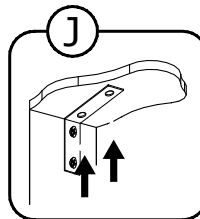
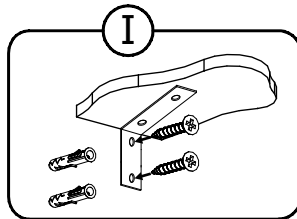
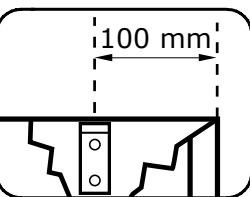
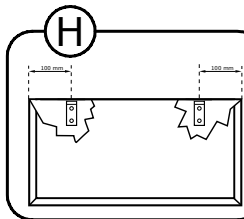
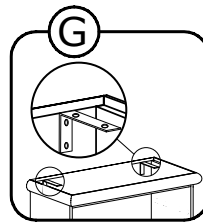
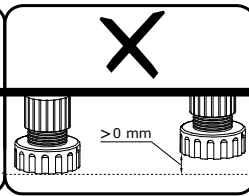
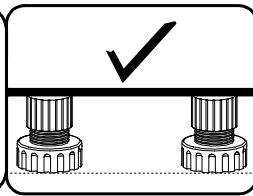
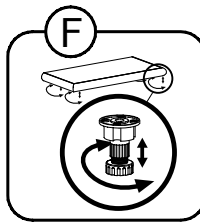
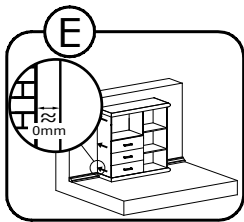
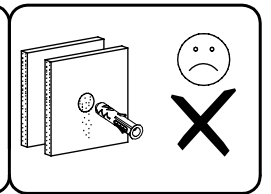
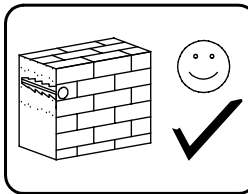
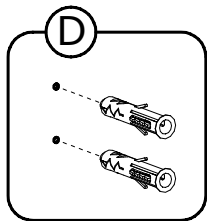
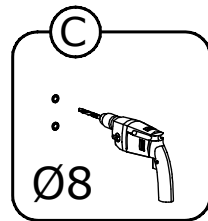
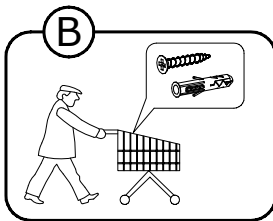
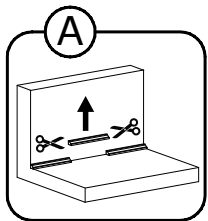
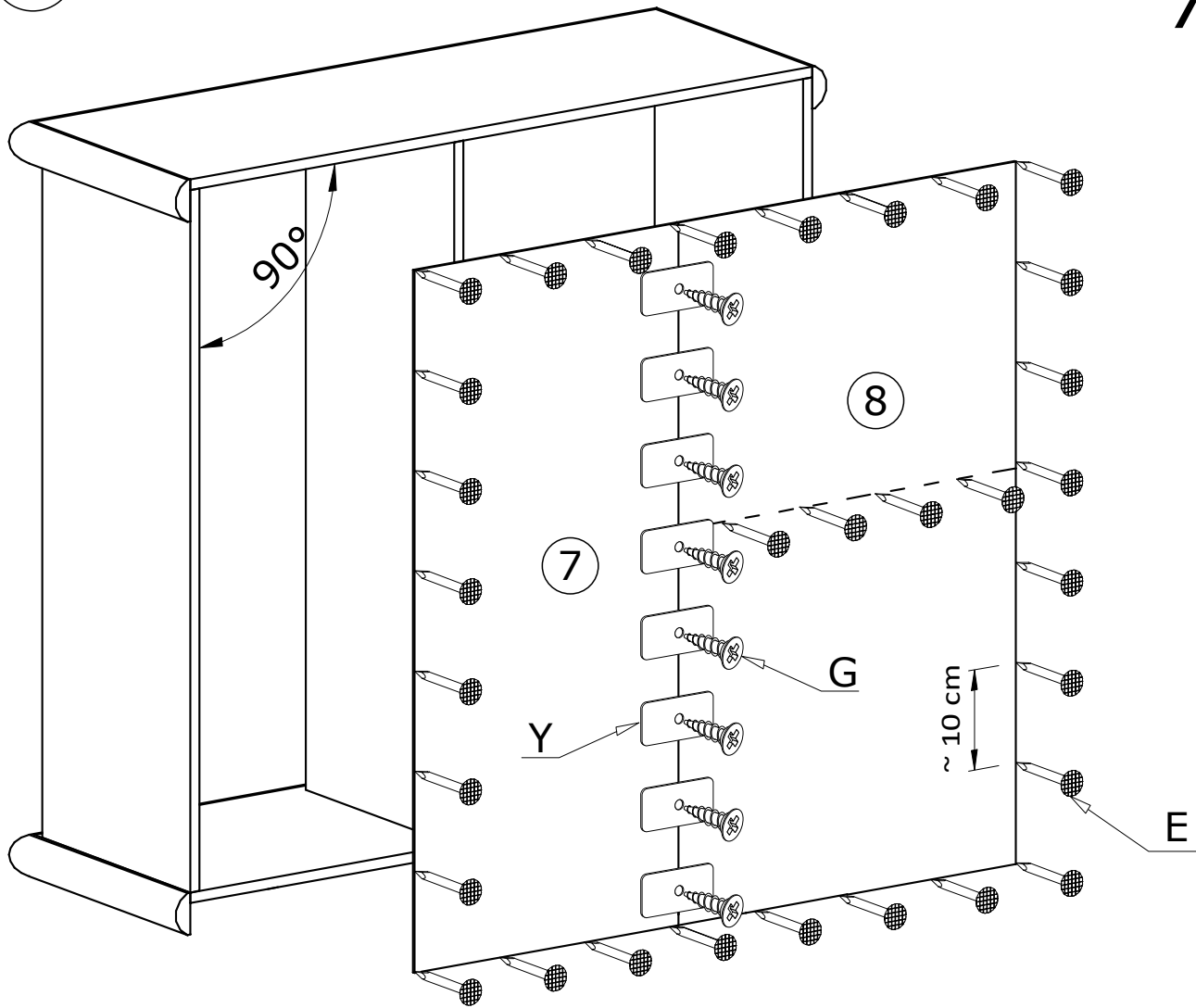

IV

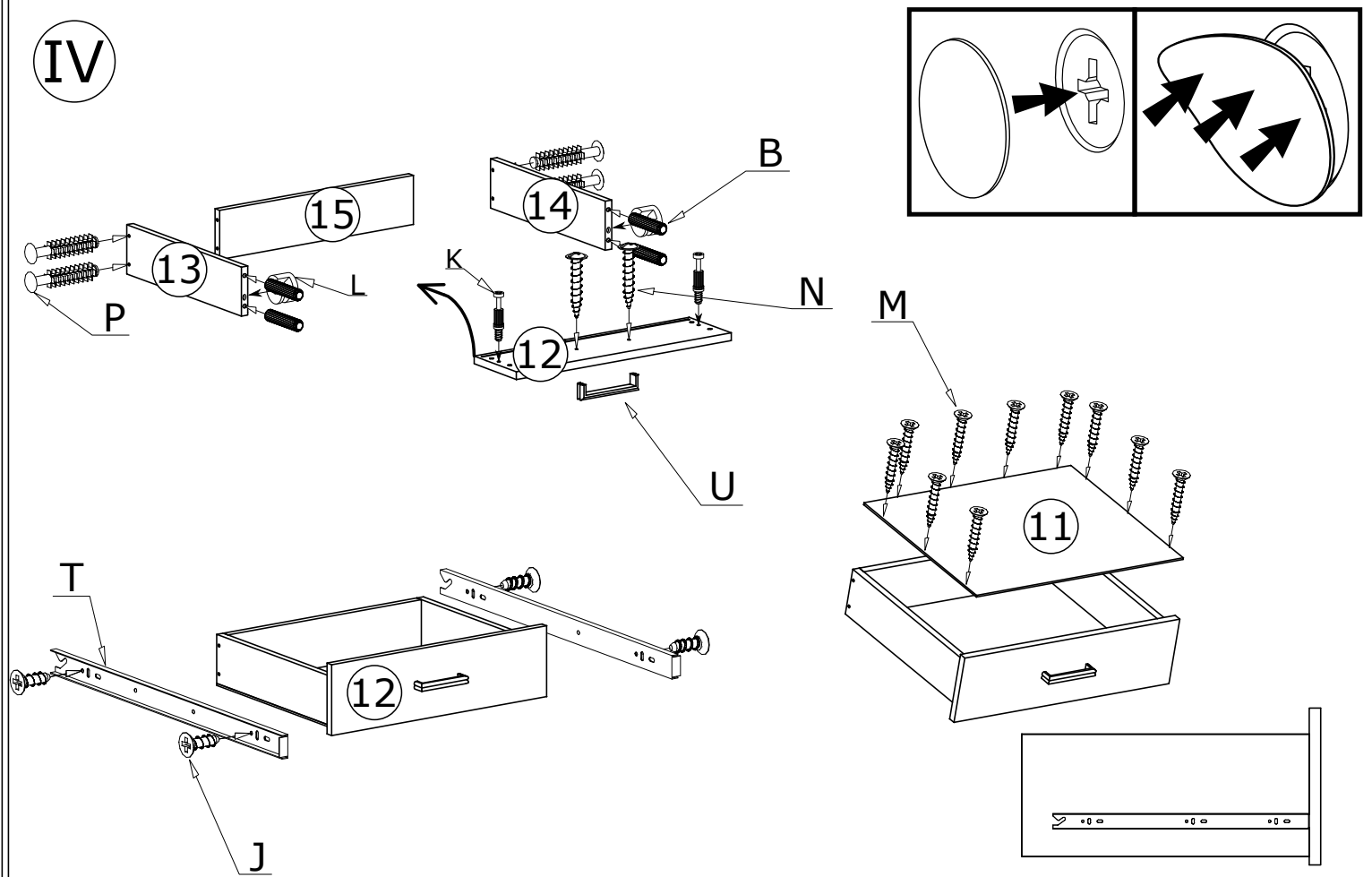

V

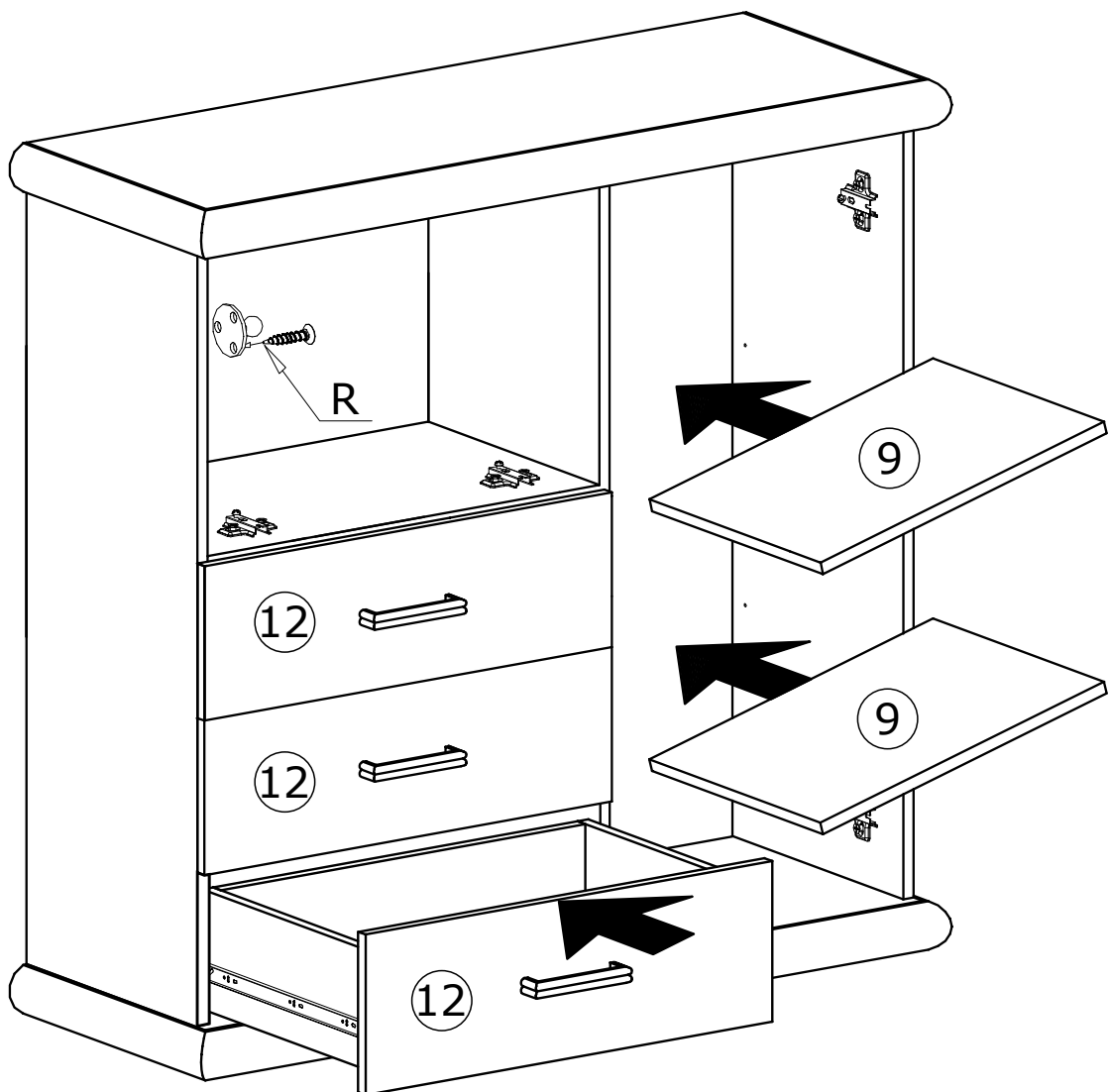

VI

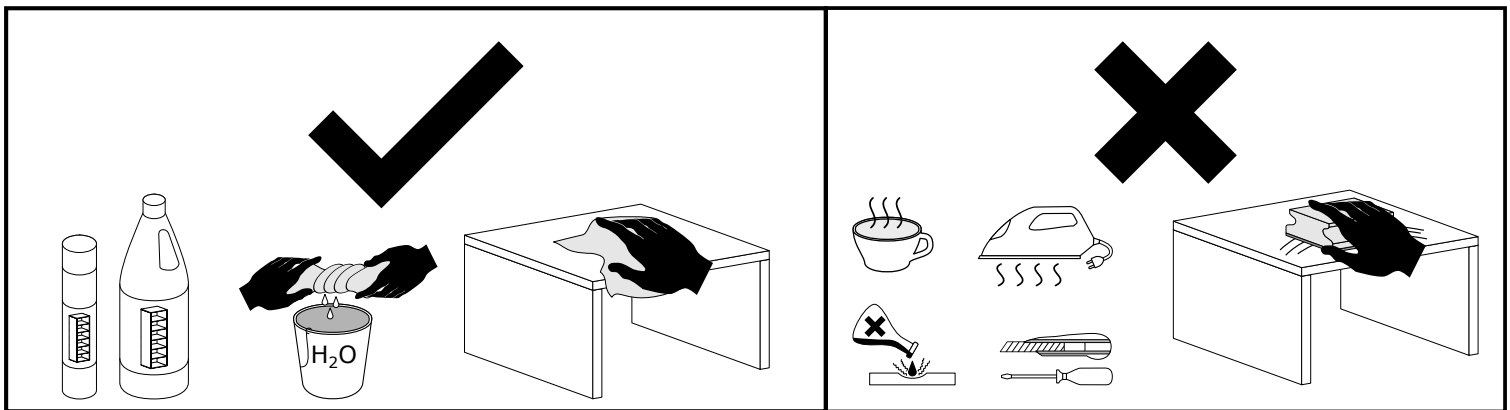
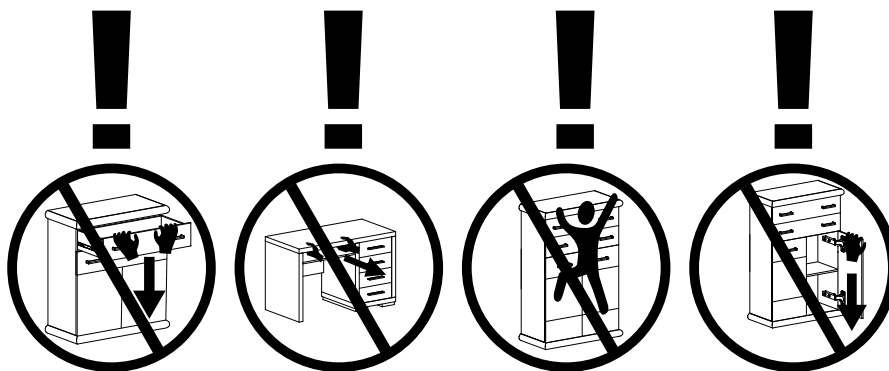
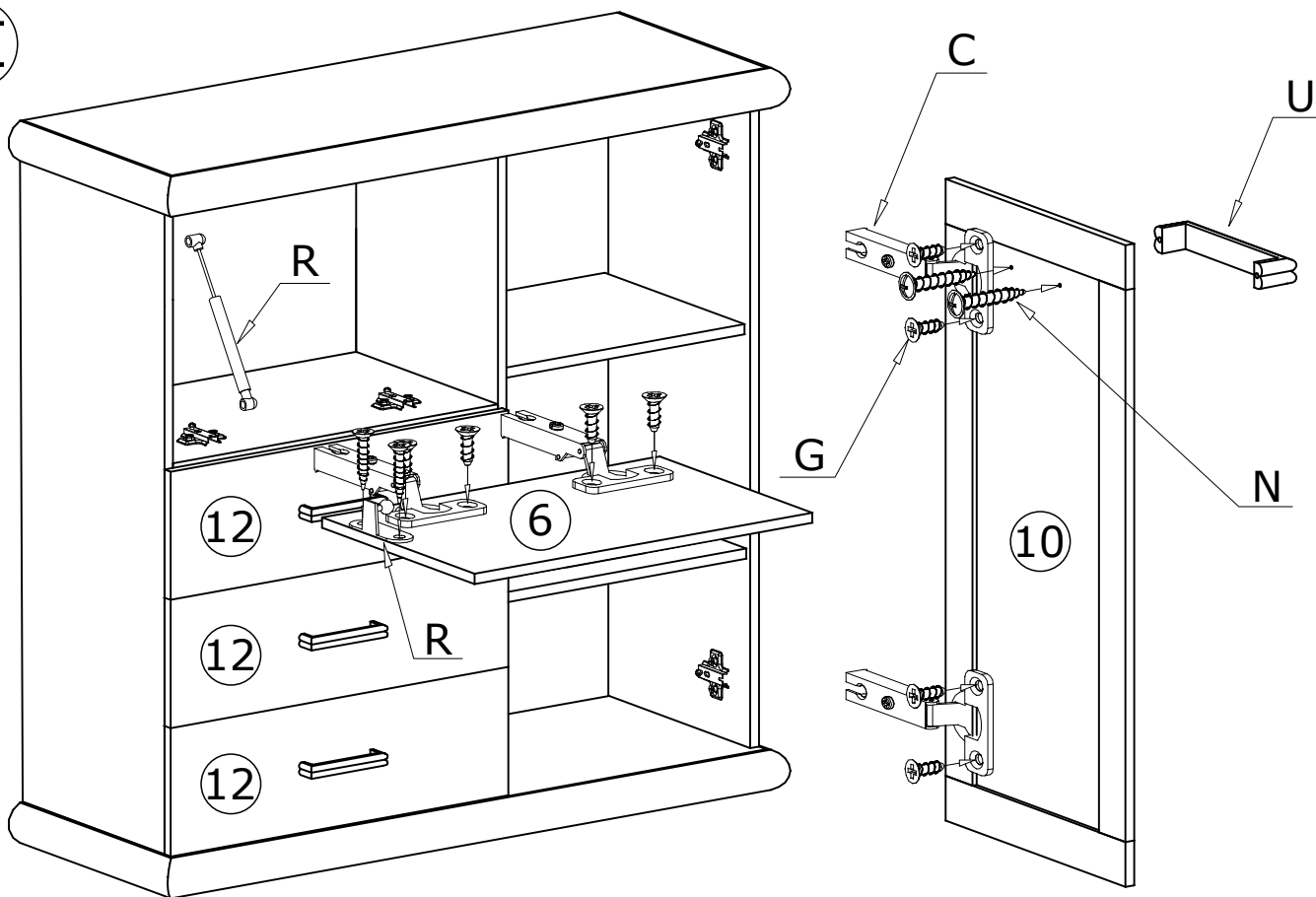

Meble zawierają elementy drewniane, których barwa i układ słojów są uzależnione od wielu czynników, dlatego mogą występować różnice w fakturze i barwie co nie stanowi wady produktu i nie wpływa na jego jakość, trwałość i funkcjonalność.

Listwy drewniane mogą ujawniać niewielkie zmiany w kształcie i wymiarach wywołane specyficznymi warunkami eksploatacji takimi jak: wilgotność, różnice temperatur, etc.

# MONTAŻ/DEMONTAŻ PROWADNIC

1



2

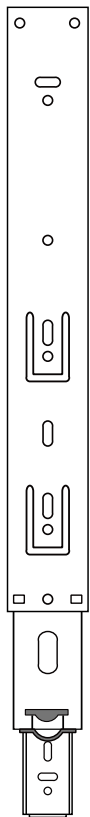

3

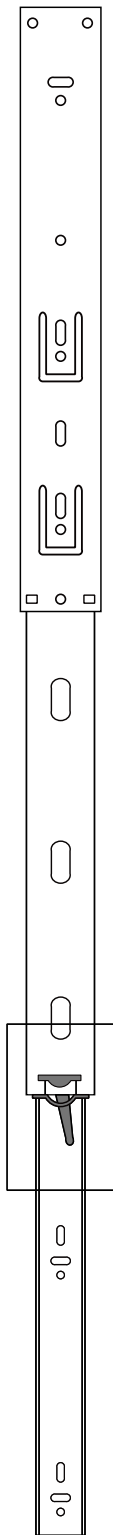

4

