

DOUGLAS 13

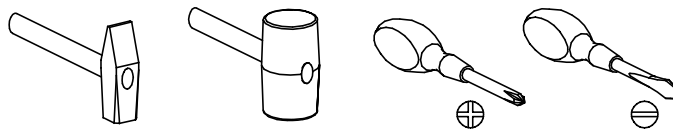

Narzędzia potrzebne do montażu



UWAGA !!!

MONTOWANIE USZKODZONYCH
ELEMENTÓW POWODUJE UTRATĘ
GWARANCJI

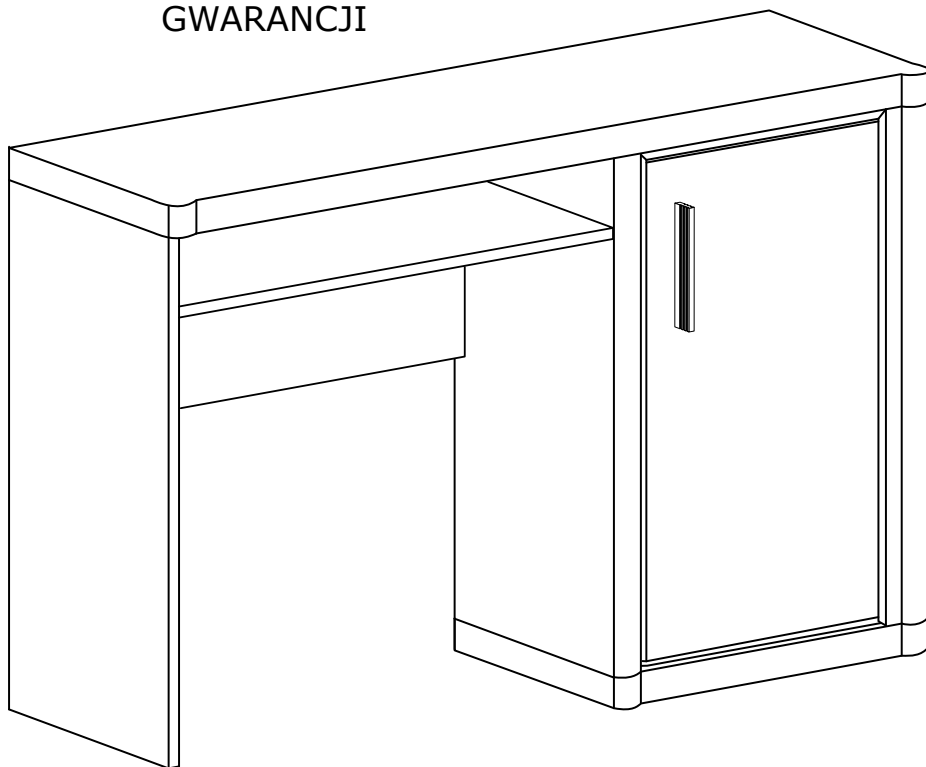

Nr	D[mm]	S[mm]	G[mm]	Ilość
1	1260	610	48	1
2	480	610	48	1
3	440	25	16	2
4	702	566	16	1
5	670	583	16	1
6	670	100	32	1
7	670	100	32	1
8	520	446	16	1
9	725	566	16	1
10	763	260	16	1
11	730	470	2,5	1
12	738	400	16	1
13	645	380	16	1

W przypadku reklamacji proszę podać numer pakowacza znajdujący się na kartonie.

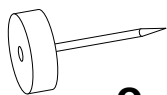

O - 2 St.

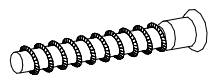

W - 4 St.

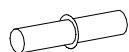

P - 4 St.



M - 8 St.
4x25 mm

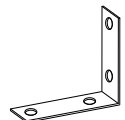

Y - 2 St.



I - 4 St.
3,5x16 mm

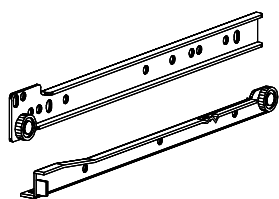

T - 1 Kpl.



N - 2 St.
4x30 mm



U - 1 St.

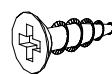

G - 8 St.
3,5x16 mm



L - 13 St.



E - 20 St.

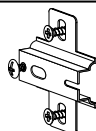

C - 2 St.

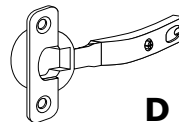

D - 2 St.



S - 1 St.



A - 4 St.



B - 10 St.

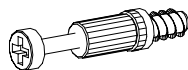

K - 13 St.

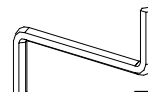

Z - 1 St.



J - 4 St.
5x13 mm

I

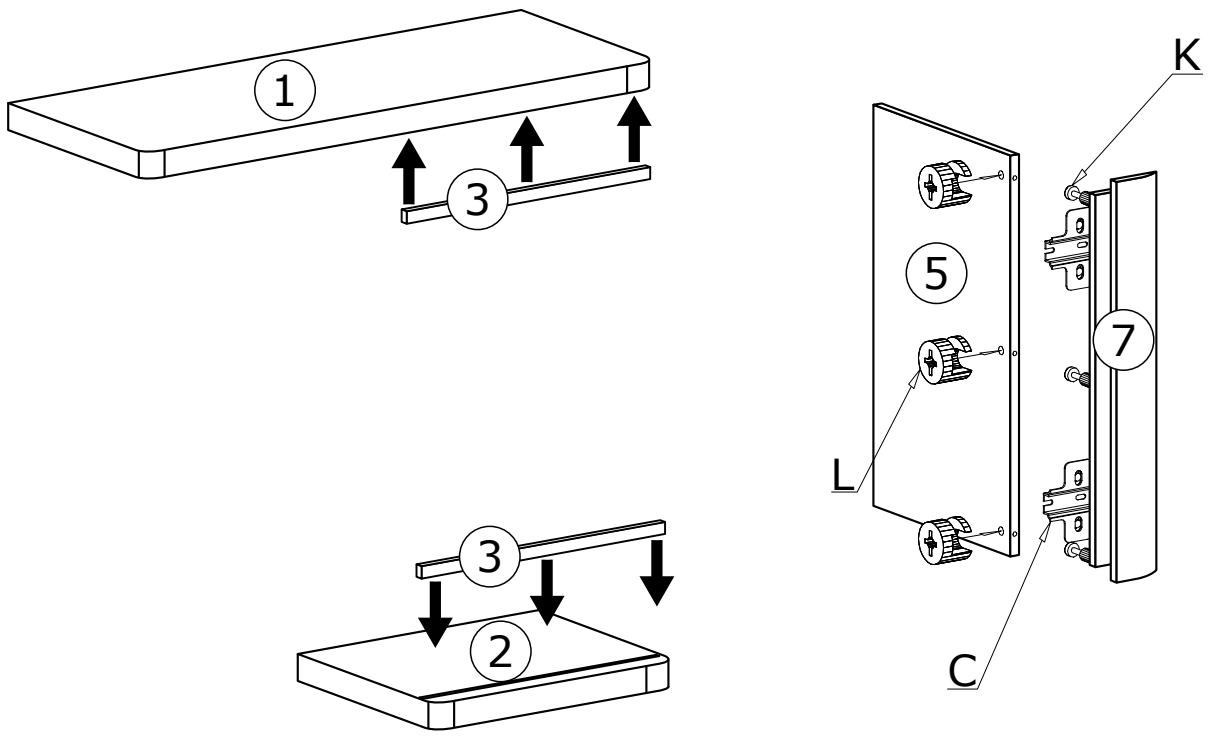

II

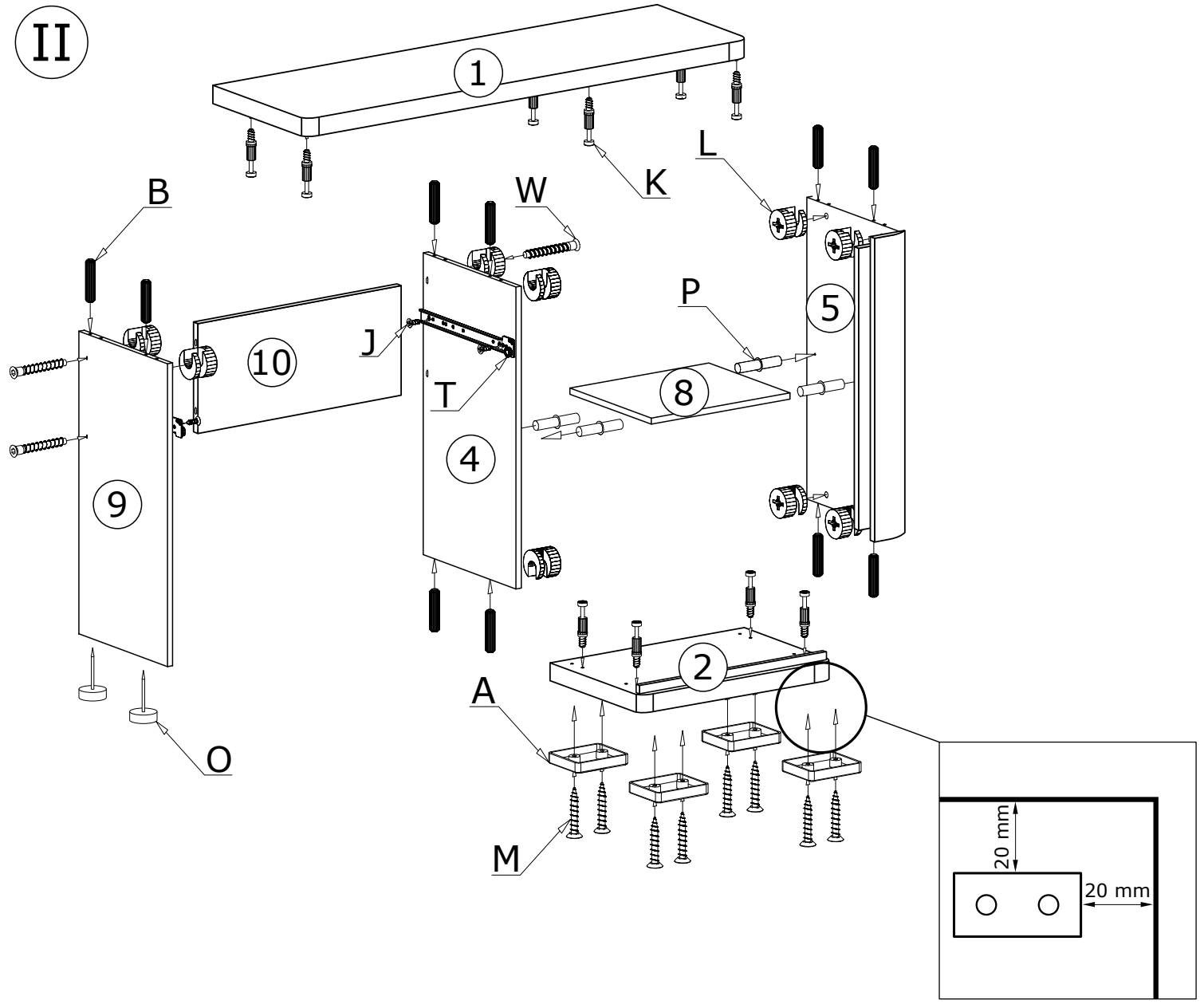

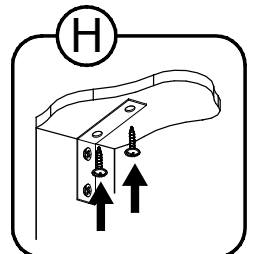
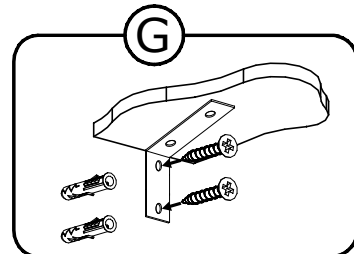
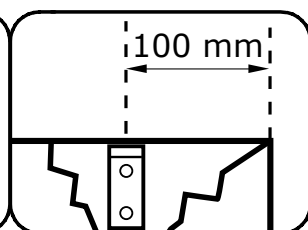
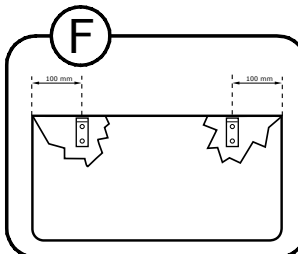
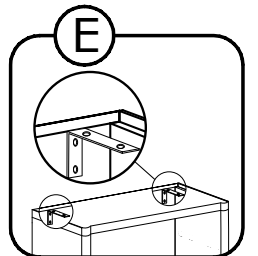
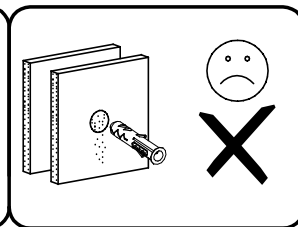
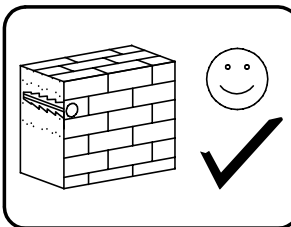
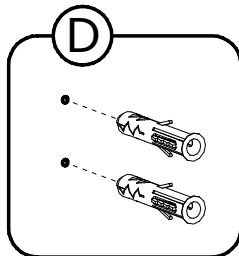
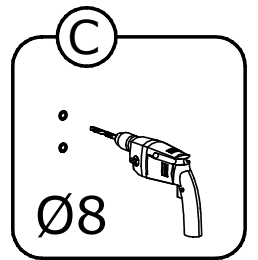
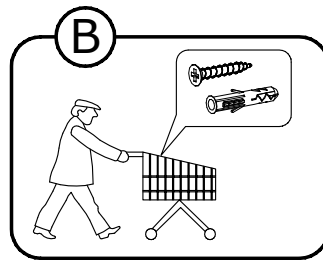
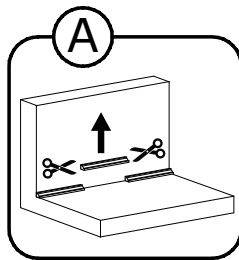
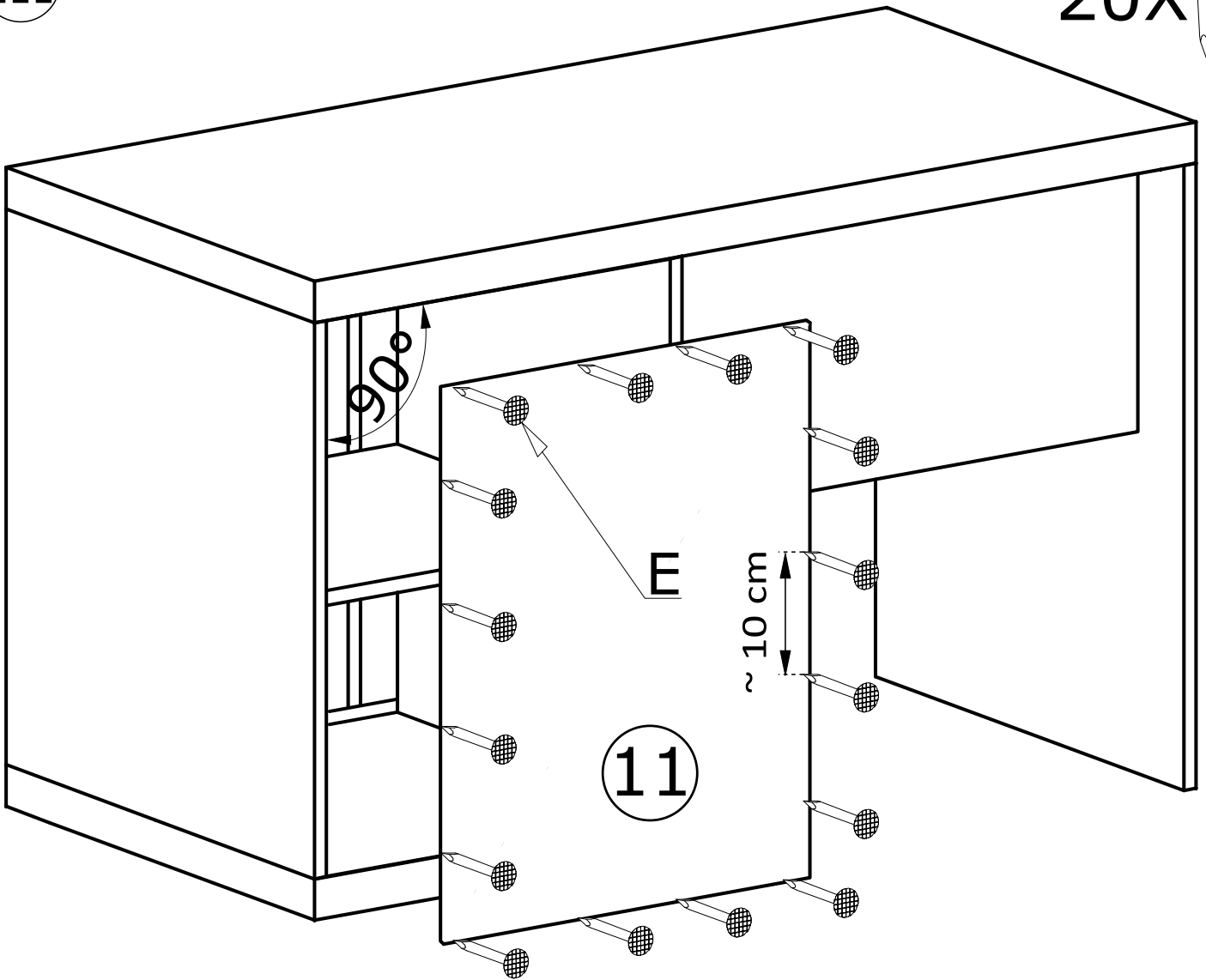

IV

