

# DOUGLAS 11

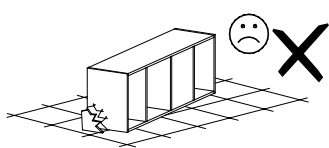

Narzędzia potrzebne do montażu

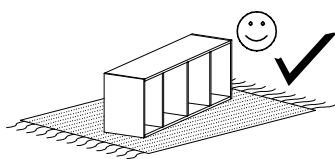
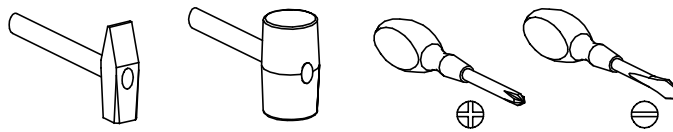

## UWAGA !!!

MONTOWANIE USZKODZONYCH  
ELEMENTÓW POWODUJE UTRATĘ  
GWARANCJI

Nr	D[mm]	S[mm]	G[mm]	Ilość
1	1070	500	48	1
2	1070	500	48	1
3	1030	25	16	2
4	609	472	16	1
5	609	472	16	1
6	609	100	32	1
7	609	100	32	1
8	455	422	16	1
9	508	430	16	1
10	1035	455	16	1
11	508	430	16	1
12	1060	223	2,5	1
13	1060	447	2,5	1
14	510	420	16	1

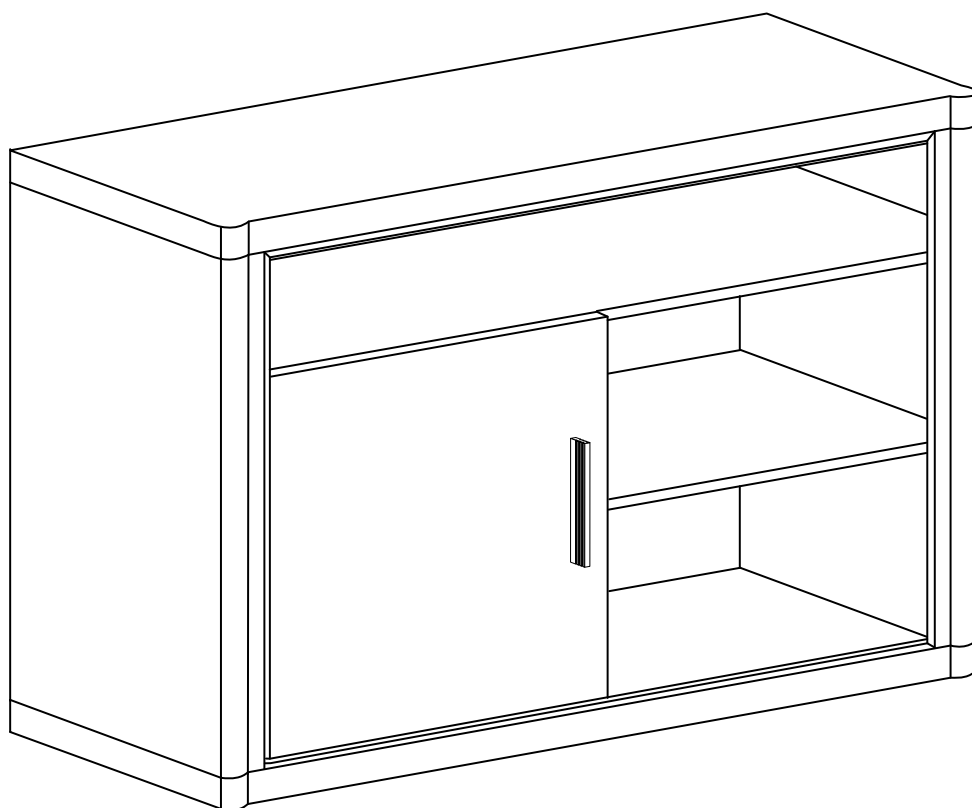

W przypadku reklamacji proszę podać numer pakowacza znajdujący się na kartonie.

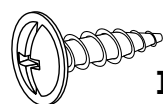

**I - 2 St.**  
3,5x16 mm

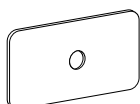

**S - 10 St.**



**X1 - 14 St.**



**X1 - 6 St.**

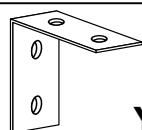

**Y - 1 St.**

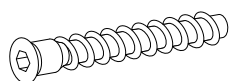

**W - 8 St.**

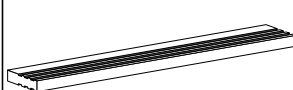

**U - 1 St.**

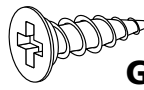

**G - 14 St.**  
3,5x16 mm



**L - 12 St.**

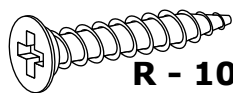

**R - 10 St.**  
3,9x25 mm



**E - 30 St.**

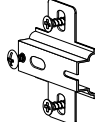

**C - 2 St.**

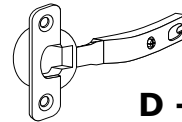

**D - 2 St.**

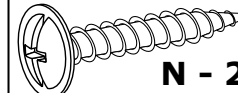

**N - 2 St.**  
4x27 mm



**A - 5 St.**

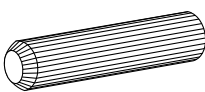

**B - 14 St.**

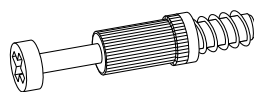

**K - 12 St.**



**Z - 1 St.**

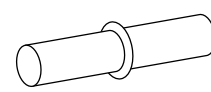

**P - 8 St.**

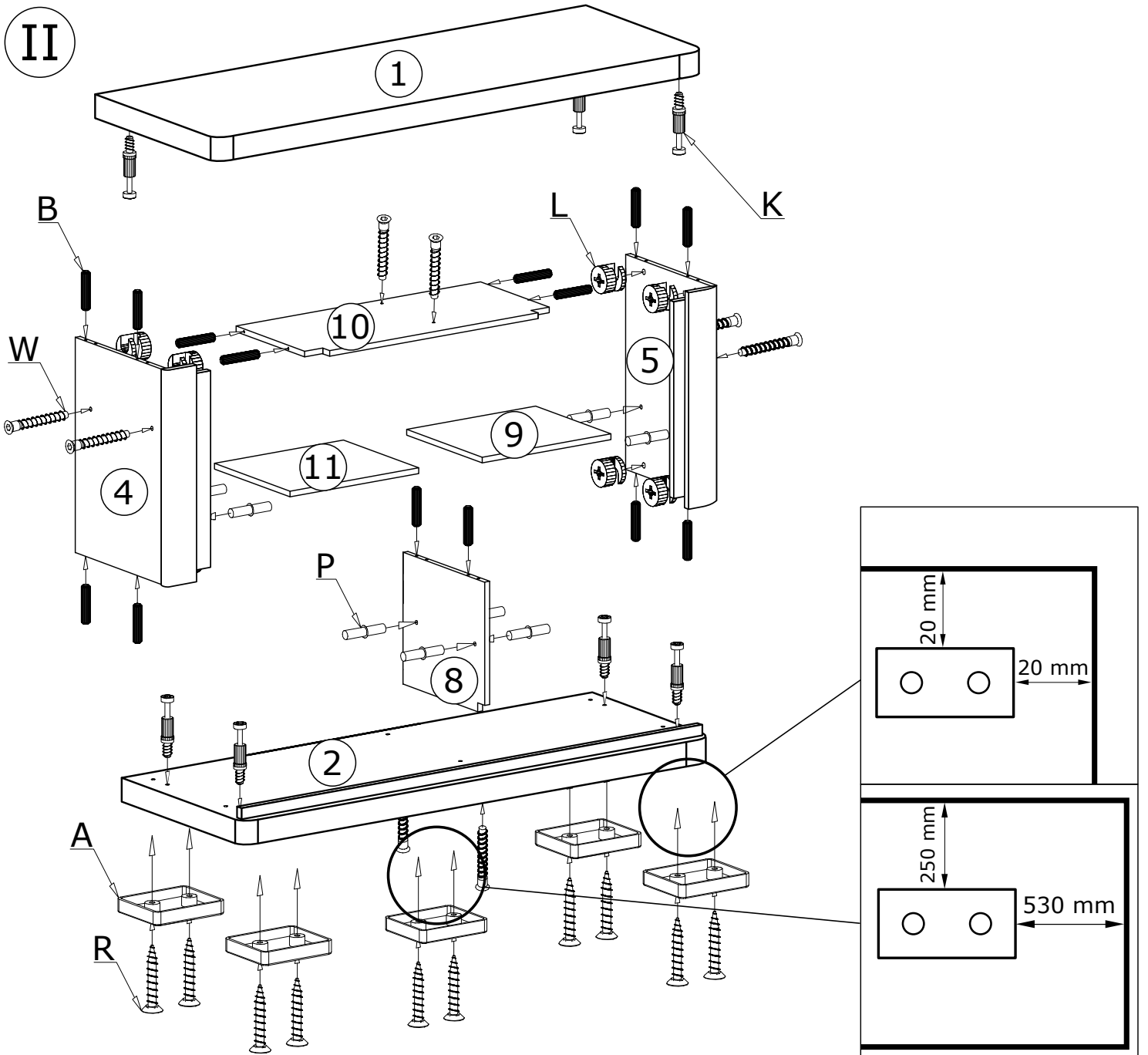
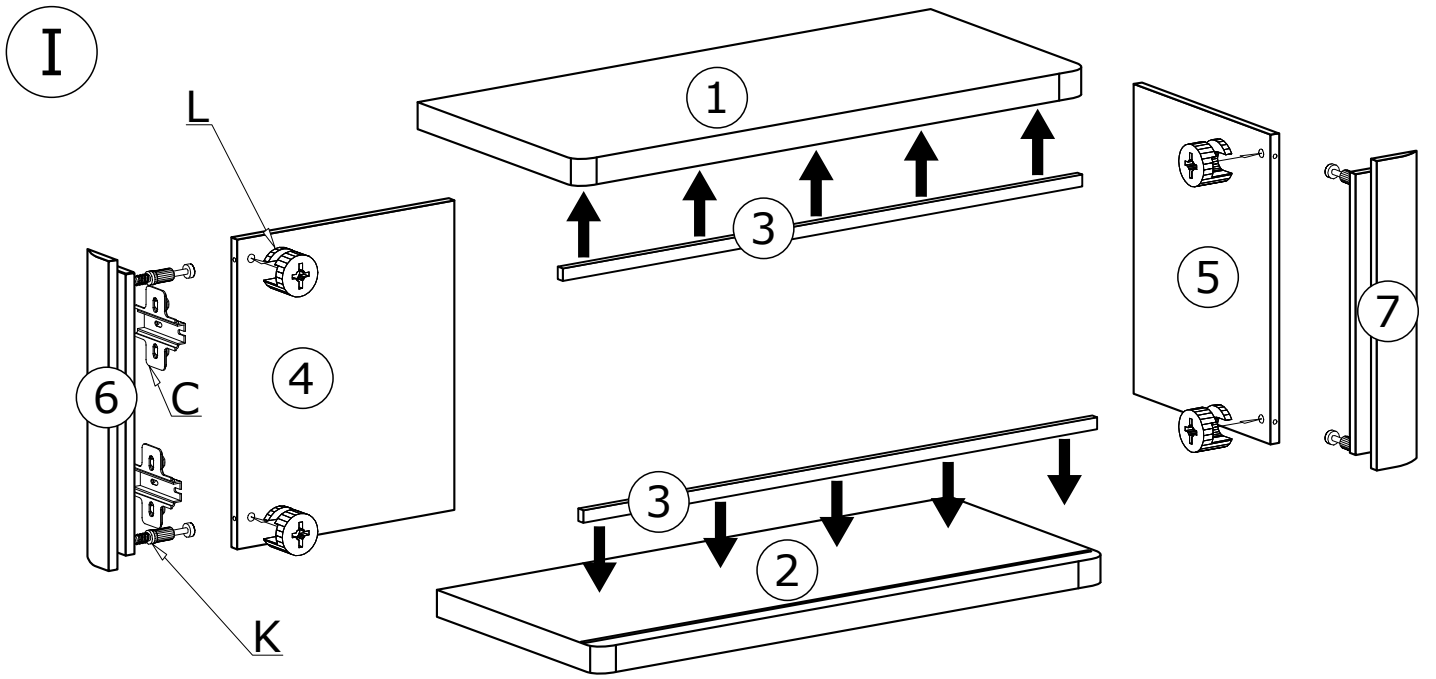

IV

30X 

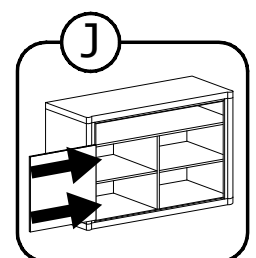
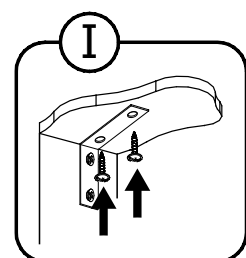
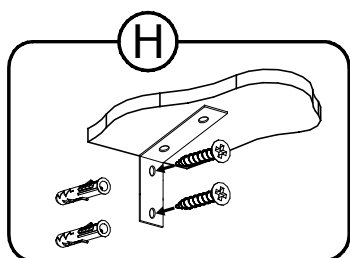
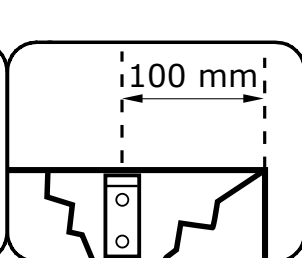
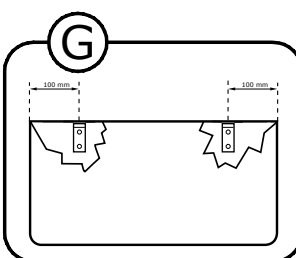
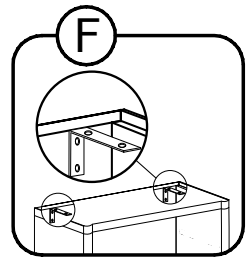
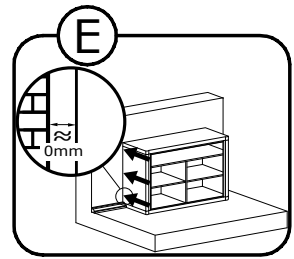
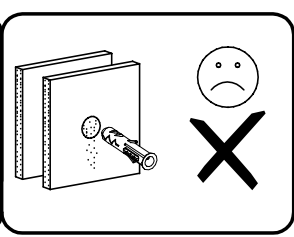
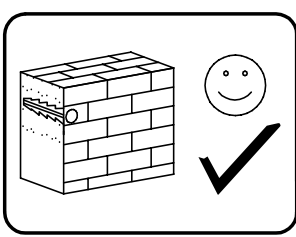
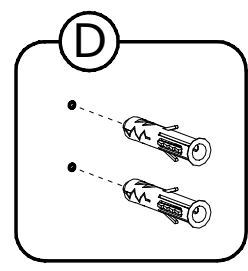
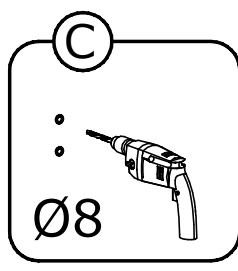
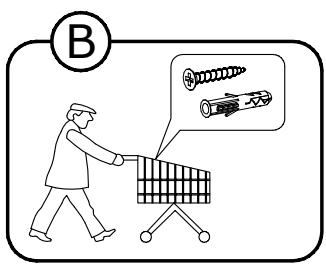
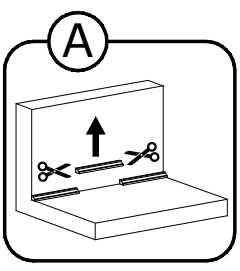
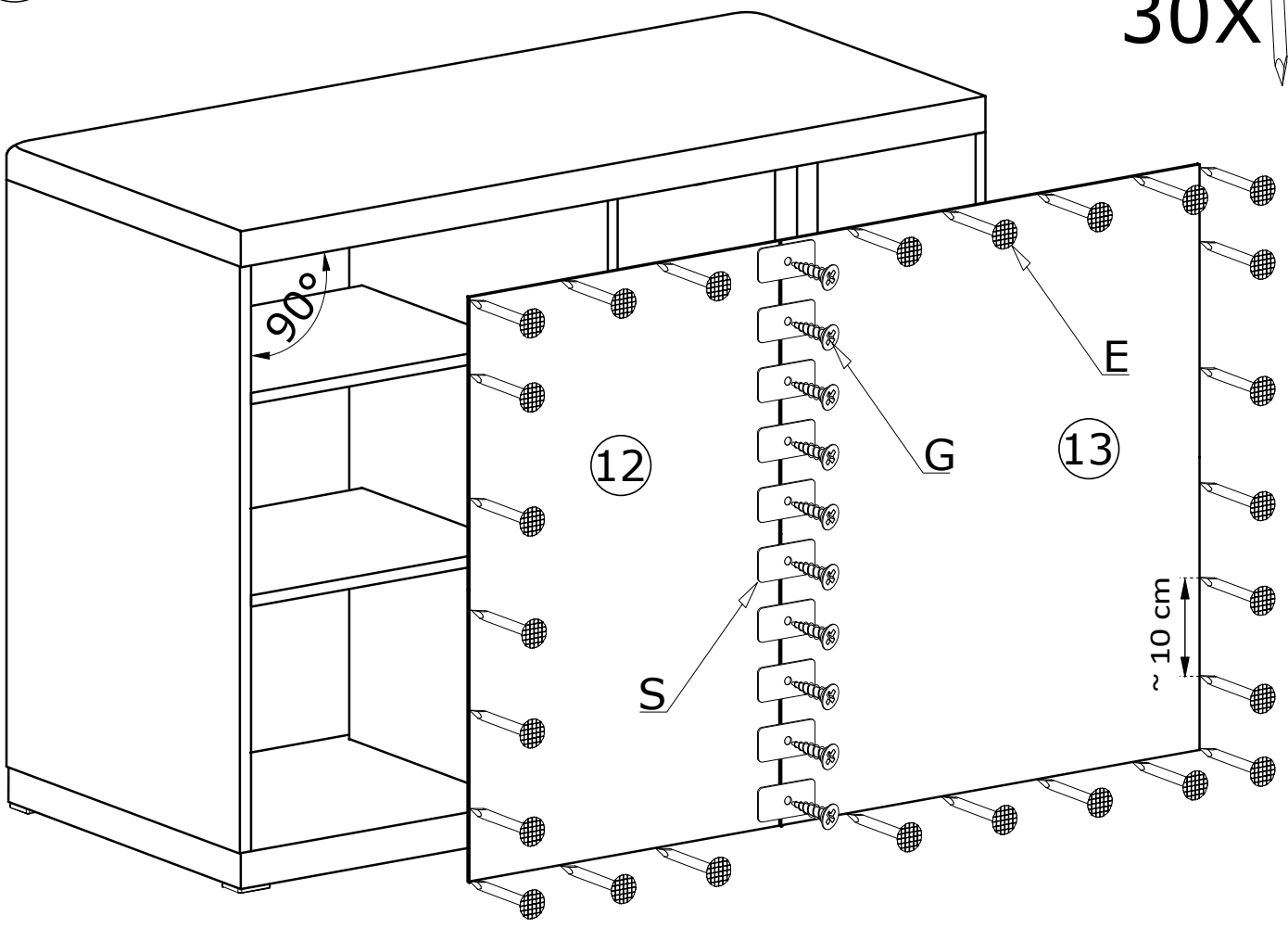

V

