



www.MLMEBLE.pl



www.MLMEBLE.pl

GB assembly instructions / D montageanleitung / CZ montážní návod / SK montážny návod / RUS инструкции по монтажу

GB assembly instructions / D montageanleitung / CZ montážní návod / SK montážny návod / RUS инструкции по монтажу



INSTRUKCJA MONTAŻU

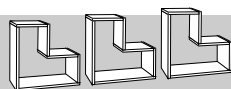

PÓŁKI L
↑50 →50 ↗20





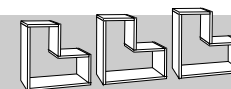



INSTRUKCJA MONTAŻU

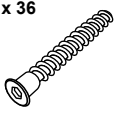



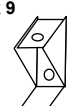

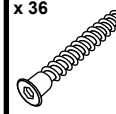

PÓŁKI L
↑50 →50 ↗20

akcesoria / accessories / zubehör / příslušenství / příslušenstvo / аксессуары :

x 36  KT 7/60	x 36  ZAK	x 1  kluczyk / key / schlüssel / klíč / klúč / ключ	x 9  WT 3,5x16	x 9  PK 25	x 2  ZS Ø5
---	--	--	---	---	---

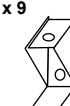
akcesoria / accessories / zubehör / příslušenství / příslušenstvo / аксессуары :

x 36  KT 7/60	x 36  ZAK	x 1  kluczyk / key / schlüssel / klíč / klúč / ключ	x 9  WT 3,5x16	x 9  PK 25	x 2  ZS Ø5
--	--	--	---	---	---

do montażu potrzebne są:
are needed for assembly:
sind erforderlich für die montage:
jsou potřebné pro montáž:
которые необходимы для сборки:

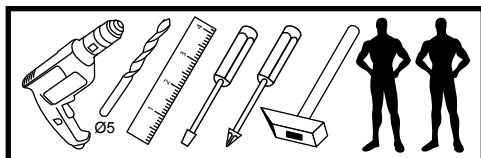

do montażu potrzebne są:
are needed for assembly:
sind erforderlich für die montage:
jsou potřebné pro montáž:
которые необходимы для сборки:

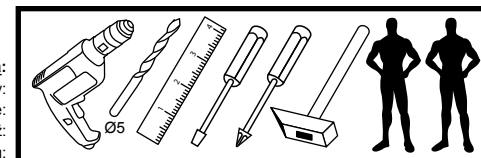

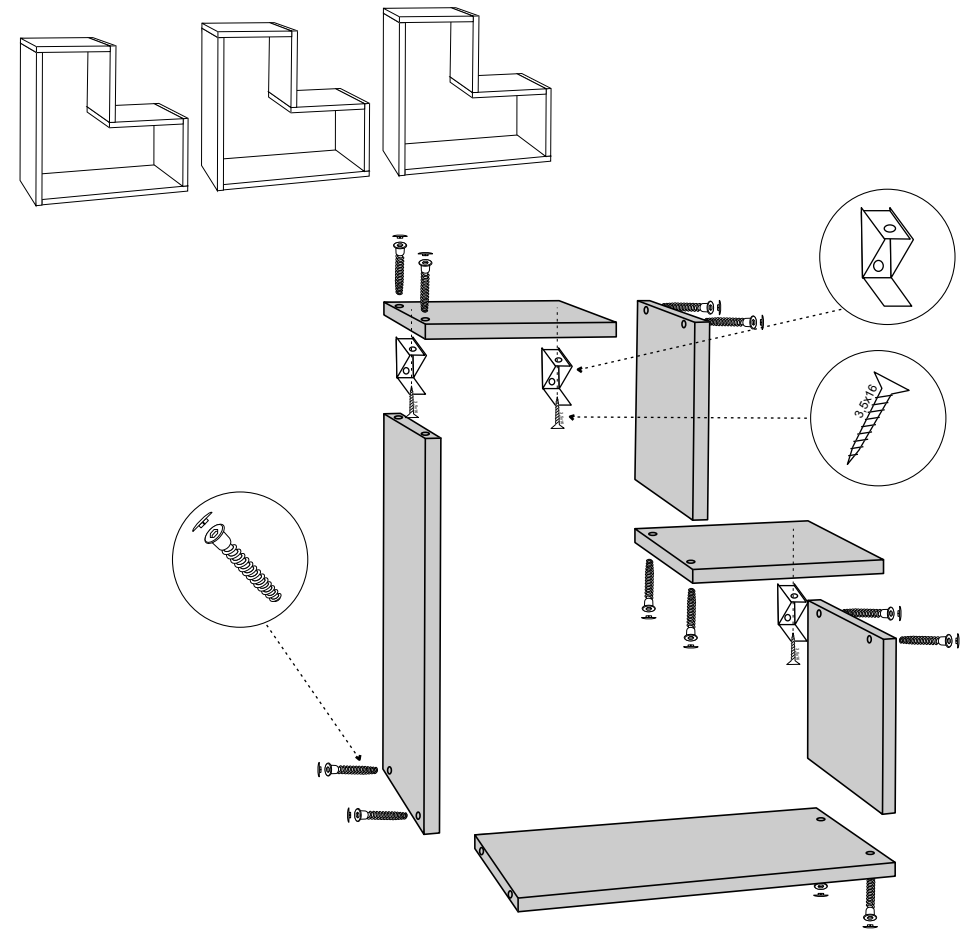
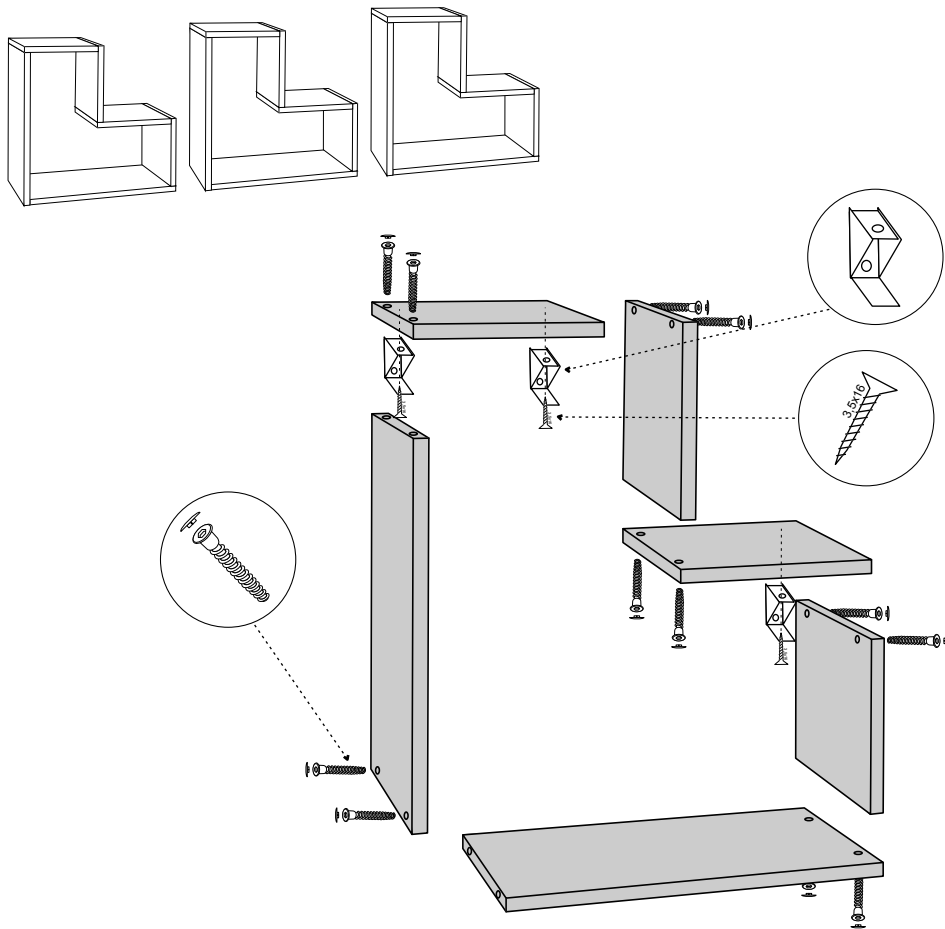

- PL** Możliwość zmontowania ze sobą półek po wcześniejszym samodzielnym wywierceniu otworu Ø5 w miejscu łączenia.
- GB** Opportunity to assemble the shelves together to advance independent Ø5 drilling the hole at the joint.
- D** Gelegenheit, die Regale zu versammeln, unabhängige Ø5 Bohren des Loches auf dem Gemeinschaftsstand Voraus.
- CZ** Možnost sestavit police společně prosazovat nezávislé Ø5 vyvrtání otvoru v kloubu.
- SK** Možnosť zostaviť police spoločne presadzovať nezávislé Ø5 vyvrtanie otvoru v kľbe.
- RUS** Возможность собирать полки сообща на благо независимой Ø5 бурение отверстий в суставе.

- PL** Możliwość zmontowania ze sobą półek po wcześniejszym samodzielnym wywierceniu otworu Ø5 w miejscu łączenia.
- GB** Opportunity to assemble the shelves together to advance independent Ø5 drilling the hole at the joint.
- D** Gelegenheit, die Regale zu versammeln, unabhängige Ø5 Bohren des Loches auf dem Gemeinschaftsstand Voraus.
- CZ** Možnost sestavit police společně prosazovat nezávislé Ø5 vyvrtání otvoru v kloubu.
- SK** Možnosť zostaviť police spoločne presadzovať nezávislé Ø5 vyvrtanie otvoru v kľbe.
- RUS** Возможность собирать полки сообща на благо независимой Ø5 бурение отверстий в суставе.

