

...twoja przestrzeń
www.meblolux.eu









Fabryka
 Mebli



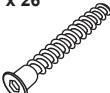



INSTRUKCJA MONTAŻU

Biurko „IRYS”

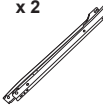
wys.: 87 szer.: 106 gł.: 55 cm

Akcesoria do montażu w zestawie:

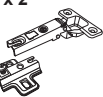
x 26  kołek	x 26  konfirmat	x 24  zaślepka konf.	x 8  ślizg	x 6  mimośród	x 28  wkręt 3,5x16	x 4  wkręt 4x35	x 1  mufa Ø 10
--	--	---	---	--	---	--	---

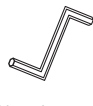
x 2  prowadnica L350	x 2  uchwyt L96	x 40  gwoździe	x 4  euro	x 2  zawiasa	x 1  klej	x 1  śruba M6	x 1  kluczyk
---	--	---	--	---	--	--	---

x 2  reling Ø 60

Potrzebne narzędzia do montażu:

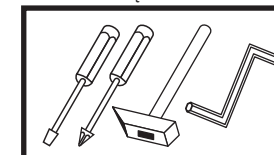

Liczba osób do montażu:



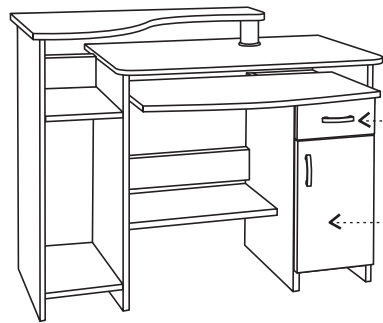

A

B

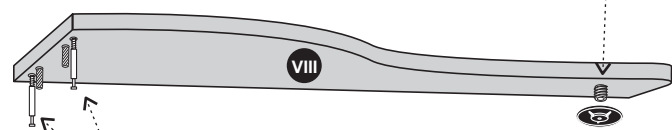

UWAGA !!!
 Kołki wbijaj w pierwszej kolejności w blaty oraz boki.

ATTENTION !!!
 Strike the pegs into flanks and blades in the first place.

ВНИМАНИЕ !!!
 Болты вбивай в первую очередь в плиты и боки.

