

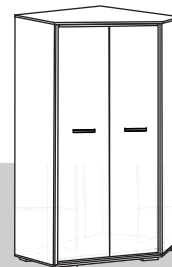

www.MLMEBLE.pl



GB assembly instructions / D montageanleitung / CZ montážní návod / SK montážny návod / RU инструкции по монтажу / LT surinkimo instrukcija



# INSTRUKCJA MONTAŻU

**BONTI 01**

↑190 →92 ↘92

akcesoria / accessories / zubehör / příslušenství / prislušenstvo / аксесуары / furnitūra :

x 18  KK 8/32	x 18  KT 6,3/50	x 100  GZ 1,4/25	x 11  MD	x 9  ZAM	x 4  UB 0	x 24  PA Ø5	x 32  WT 3,5x16	x 4  WT 4x27	x 21  WT 4x30	x 12  WT 4x35
x 6  ZA 45°	x 6  PK H-2	x 12  WE 6,3x13	x 24  BDP	x 2  drażek / stick / stock / hůl / palica / трость / styvas	x 1  LT	x 2  UTO	x 7  ST BI-150	x 1  klej / glue / kleber / lepidlo / lepido / kney / kljaj	x 1  kluczyk / key / schlüssel / klíč / kľúč / kľuch / raktas	

do montażu potrzebne są:

are needed for assembly:  
sind erforderlich für die montage:  
jsou potřebné pro montáž:  
sú potrebné pre montáž:  
которые необходимы для сборки:  
Surinkimui reikės:

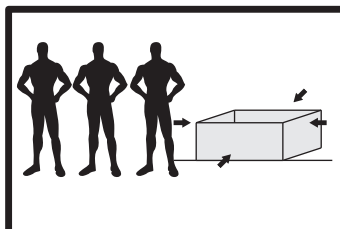
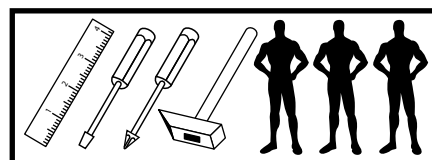

**UWAGA !** - mebel należy składać w pozycji poziomej  
**WARNING!** - furniture should be submitted in a horizontal position  
**WARNUNG!** - Möbel sollten in einer horizontalen Position vorzulegen  
**POZOR!** - Nábytek by měl být předložen ve vodorovné poloze  
**POZOR!** - Nábytok by mal byť predložený vo vodorovnej polohe  
**ВНИМАНИЕ!** - Мебель должна быть представлена в горизонтальном положении  
**DĚMESIO!** - Baldą surenkame horizontalioje padėtyje

**UWAGA !** - w pierwszej kolejności wbijamy akcesoria „KK” i „MD” w błąty oraz boki.  
**WARNING!** - The first accessory sticks "KK" and "MD" in the tops and sides.  
**WARNUNG!** - Die erste Accessoire-Sticks "KK" und "MD" in den Spitzen und an den Seiten.  
**POZOR!** - První příslušenství holi "KK" a "MD" v korunách a boky.  
**POZOR!** - Prvé príslušenstvo palíc "KK" a "MD" v korunách a boky.  
**ВНИМАНИЕ!** - Первый аксессуаров палочки "KK" и "MD" по верхинам и по бокам.  
**DĚMESIO!** - Pirmiausiai furnitūrą KK ir MD įkalame į stalviršį ir šonus.

Nr/No	Szt/Qty
1	1
2	2
3	1
4	2
5	1
6	1
7	1
8	1
9	1
10	1
11	3
12	1
13	3
14	1
15	2

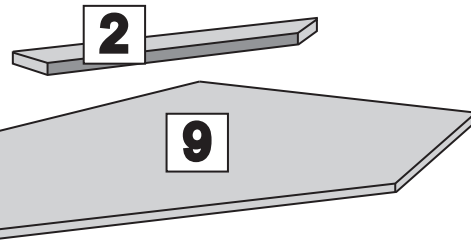
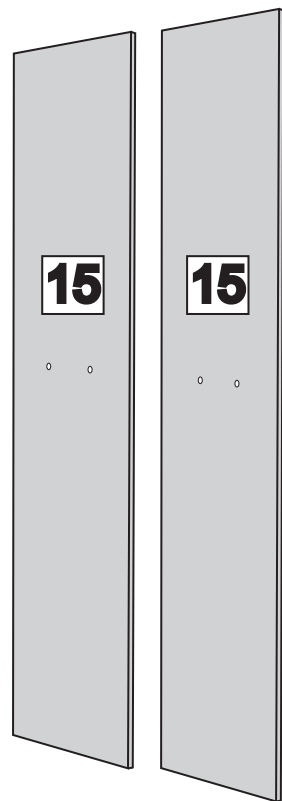
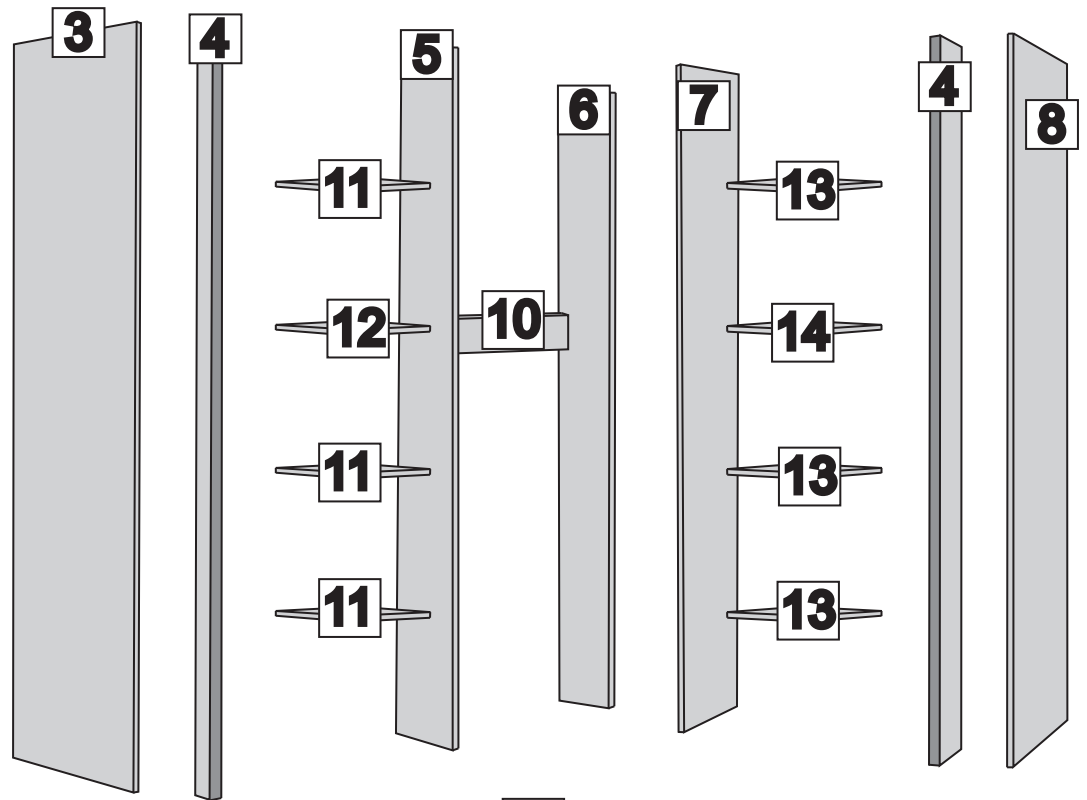
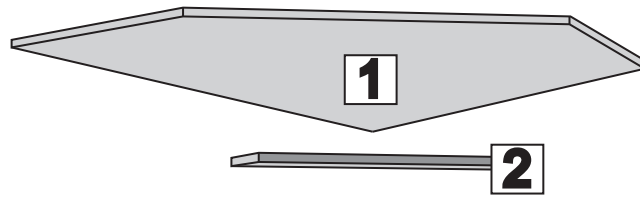

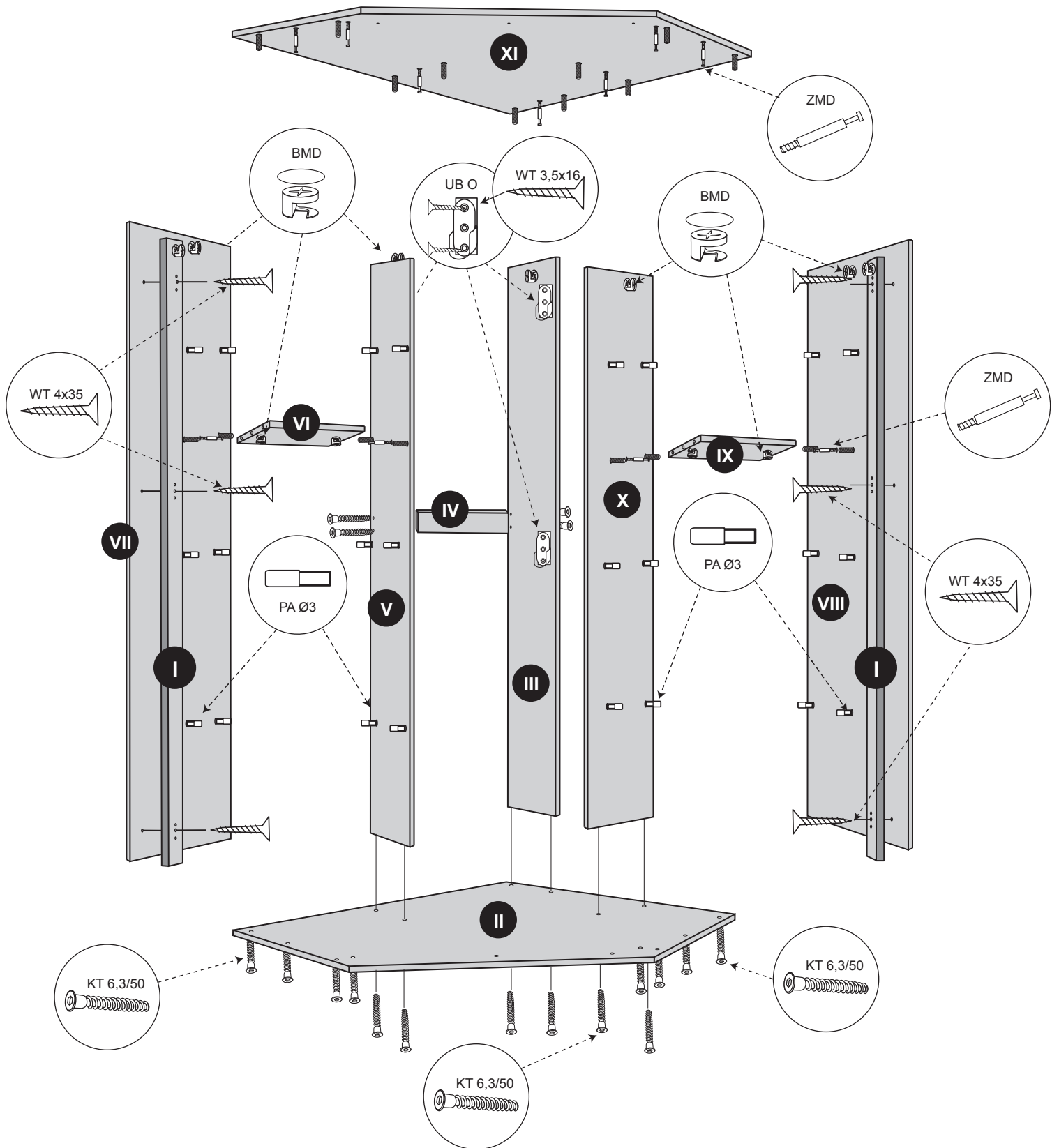

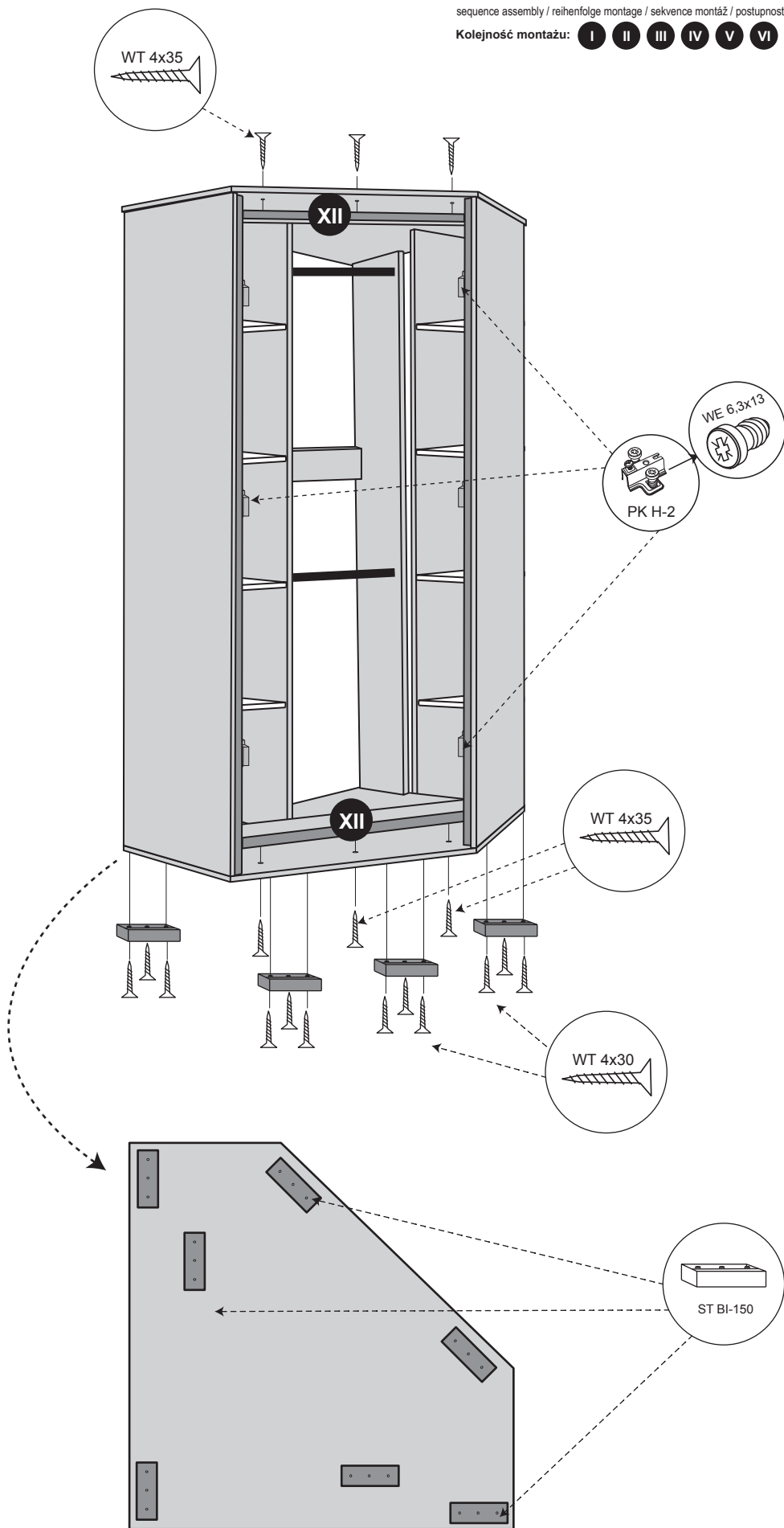

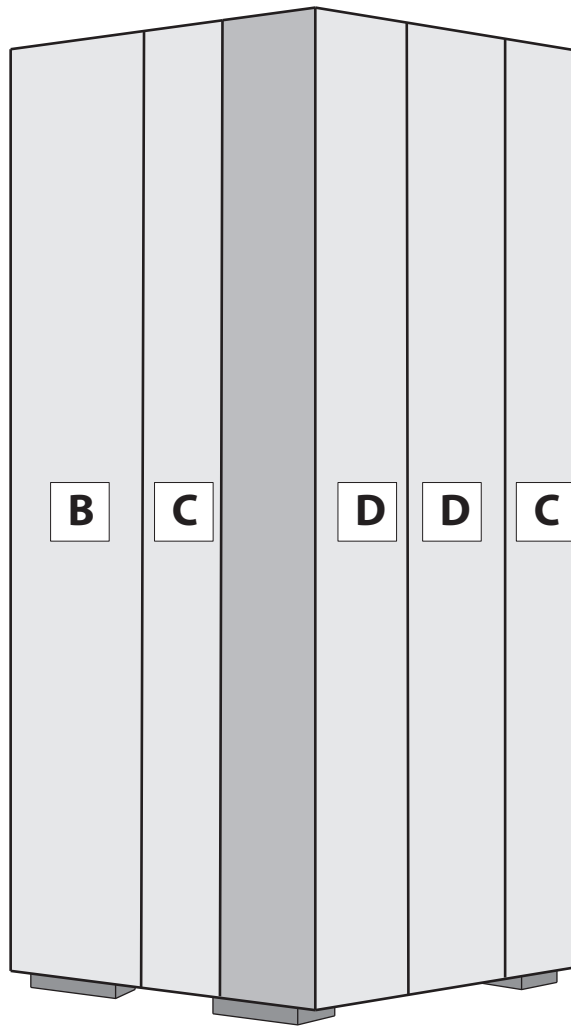

- B** 1865x353
- C** 1865x292
- D** 1865x307

