

2

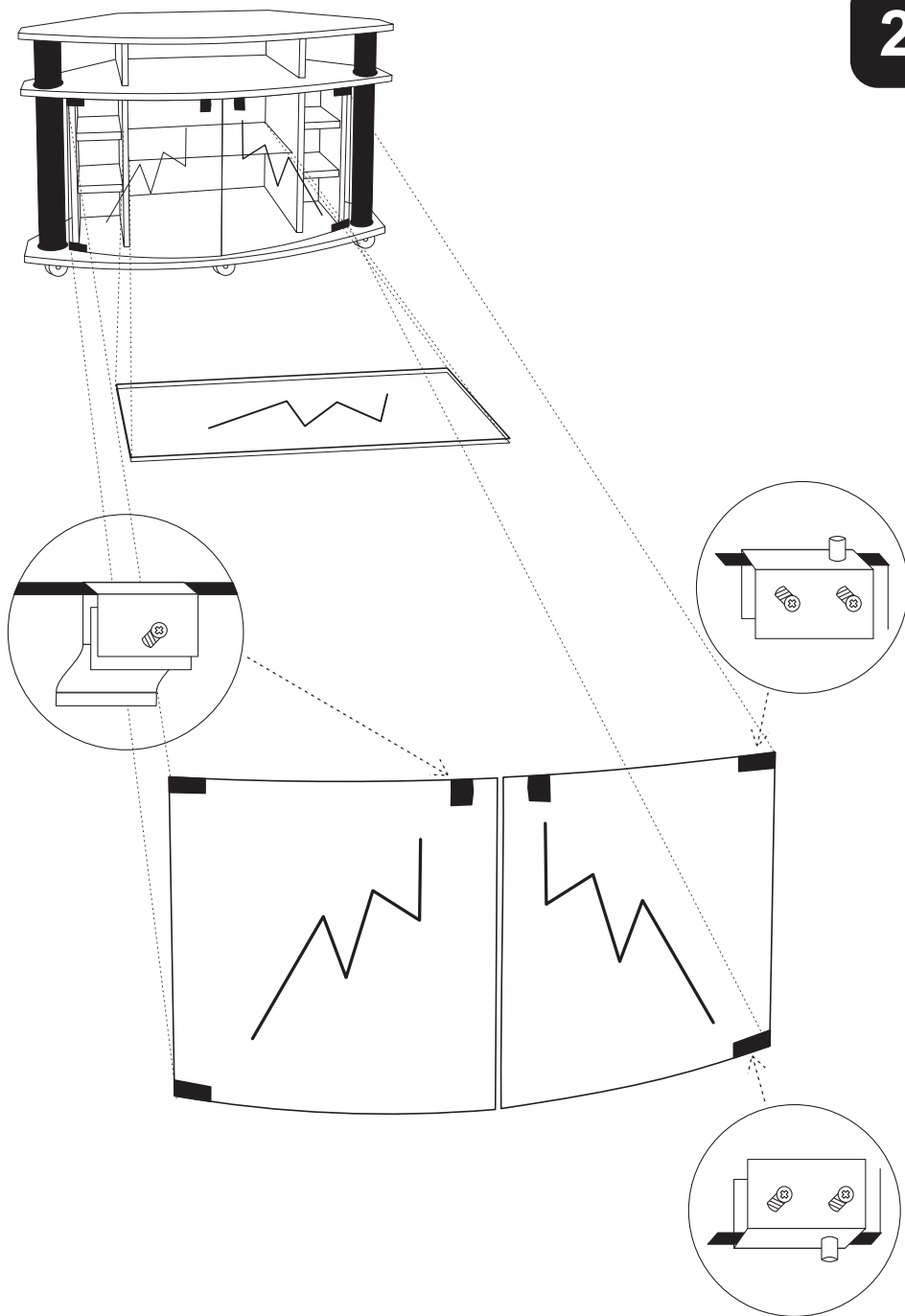

Fabryka Mebli



MEBLOLUX

# INSTRUKCJA MONTAŻU

Stolik RTV „ROBI II”

Akcesoria do montażu w zestawie:

x 24	x 20	x 30	x 10	x 5	x 2	x 1	x 2
kolek	podpórka	gwóźdź	wkręt 3x16	kółko	magnez	klej	uchwyt do szyby

x 8	x 8
reling ø 60	euro

Potrzebne narzędzia do montażu:

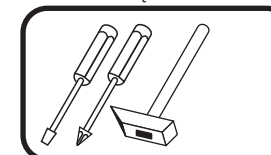

Liczba osób do montażu:

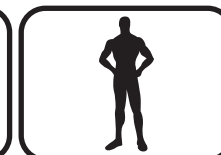

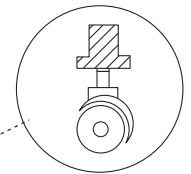
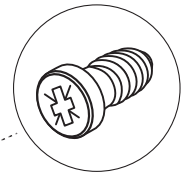
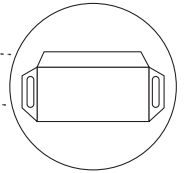
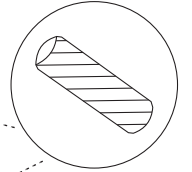
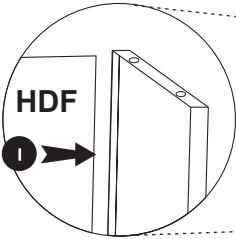
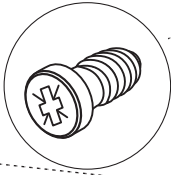
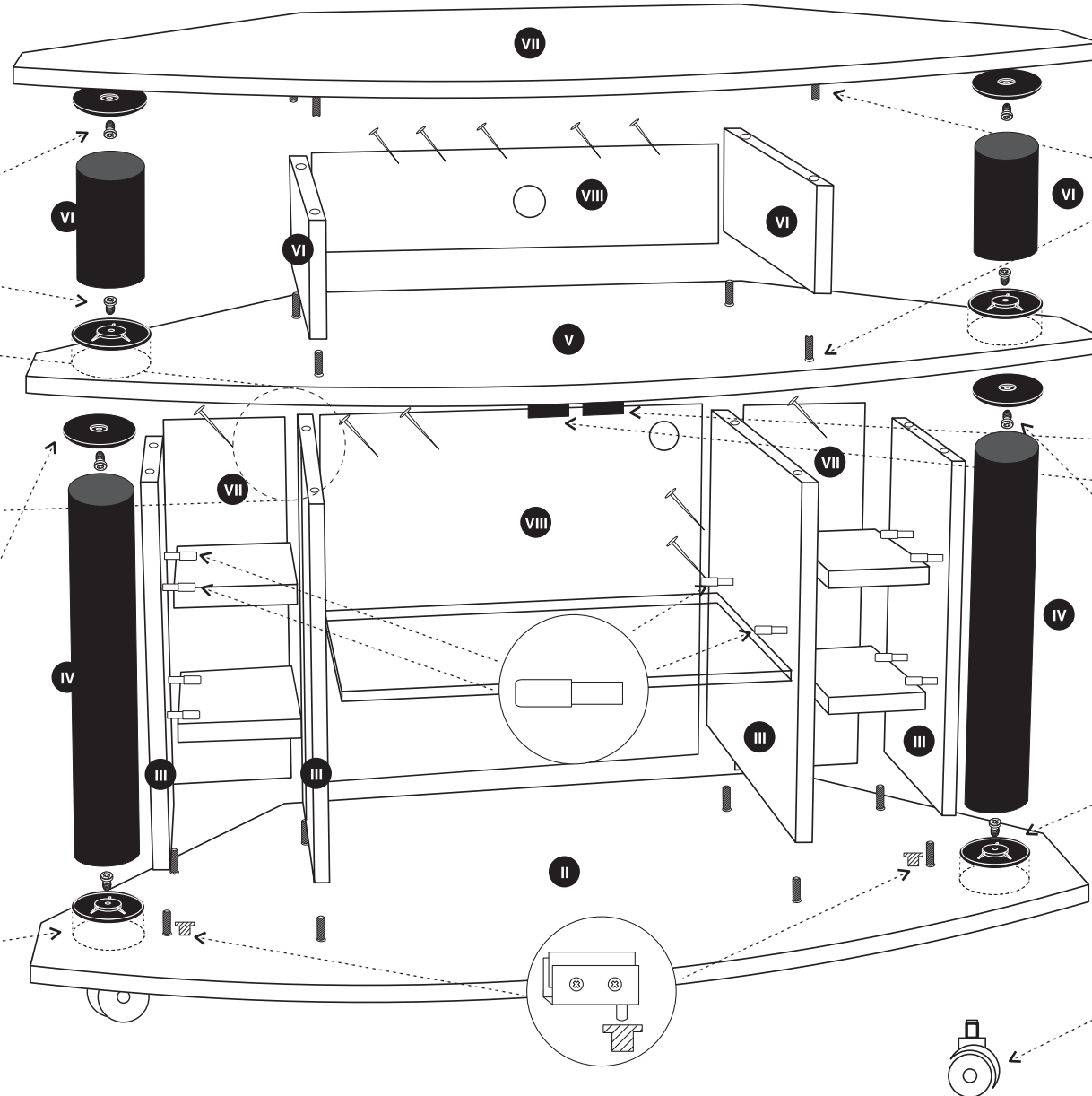
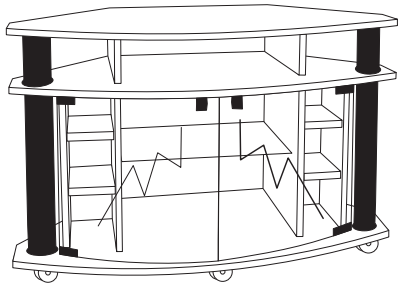

**UWAGA !!!**  
 Kołki wbijaj w pierwszej kolejności w blaty oraz boki.

**ATTENTION !!!**  
 Strike the pegs into flanks and blades in the first place.

**ВНИМАНИЕ !!!**  
 Болты вбивай в первую очередь в плиты и боки.