

PRZED ROZPOCZĘCIEM MONTAŻU ZAPOZNAĆ SIĘ Z INSTRUKCJĄ

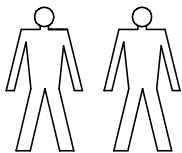

Narzędzia niezbędne do montażu (nie dostarczane przez producenta)

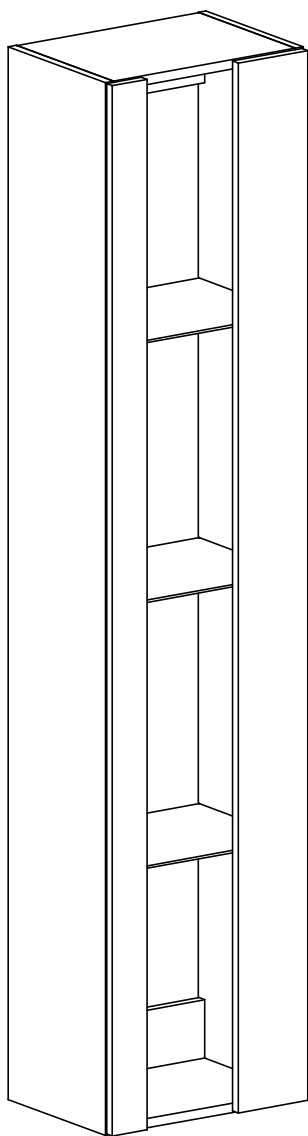
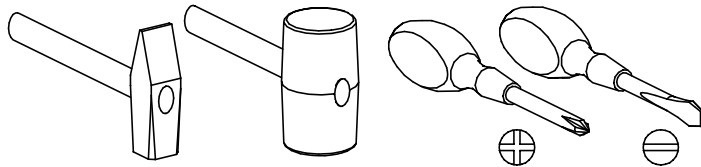

# VIGO II

Witryna

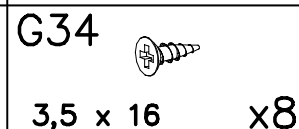
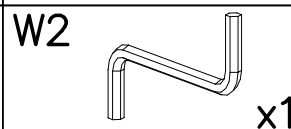
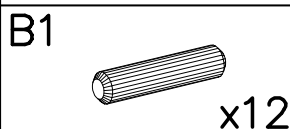
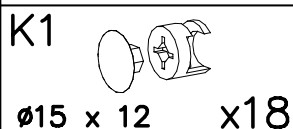
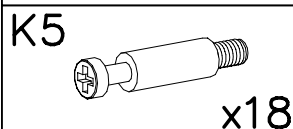
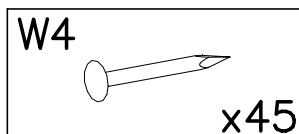
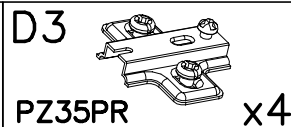
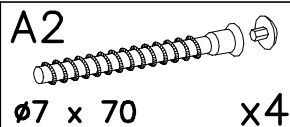
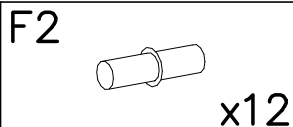
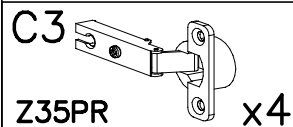

I

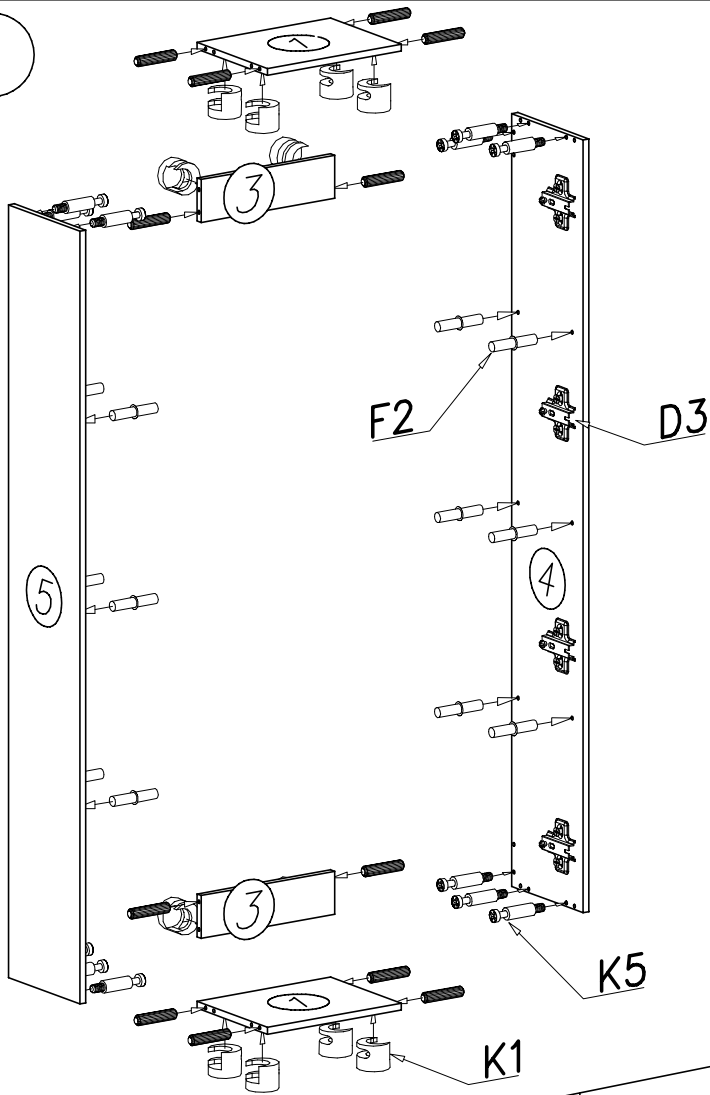

II

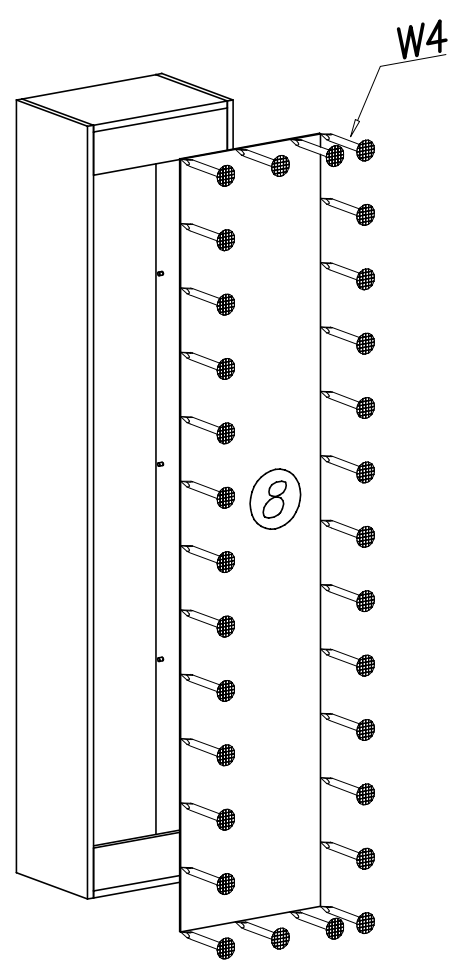

III

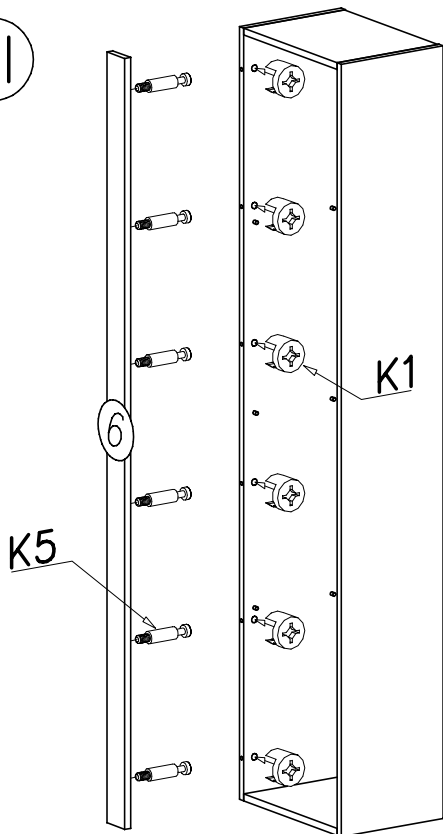

IV

