

Meblóścianka ENTER

GAŁA MEBLE Sp. z o. o.
ul. Oleśnicka 1
56-416 Twardogóra

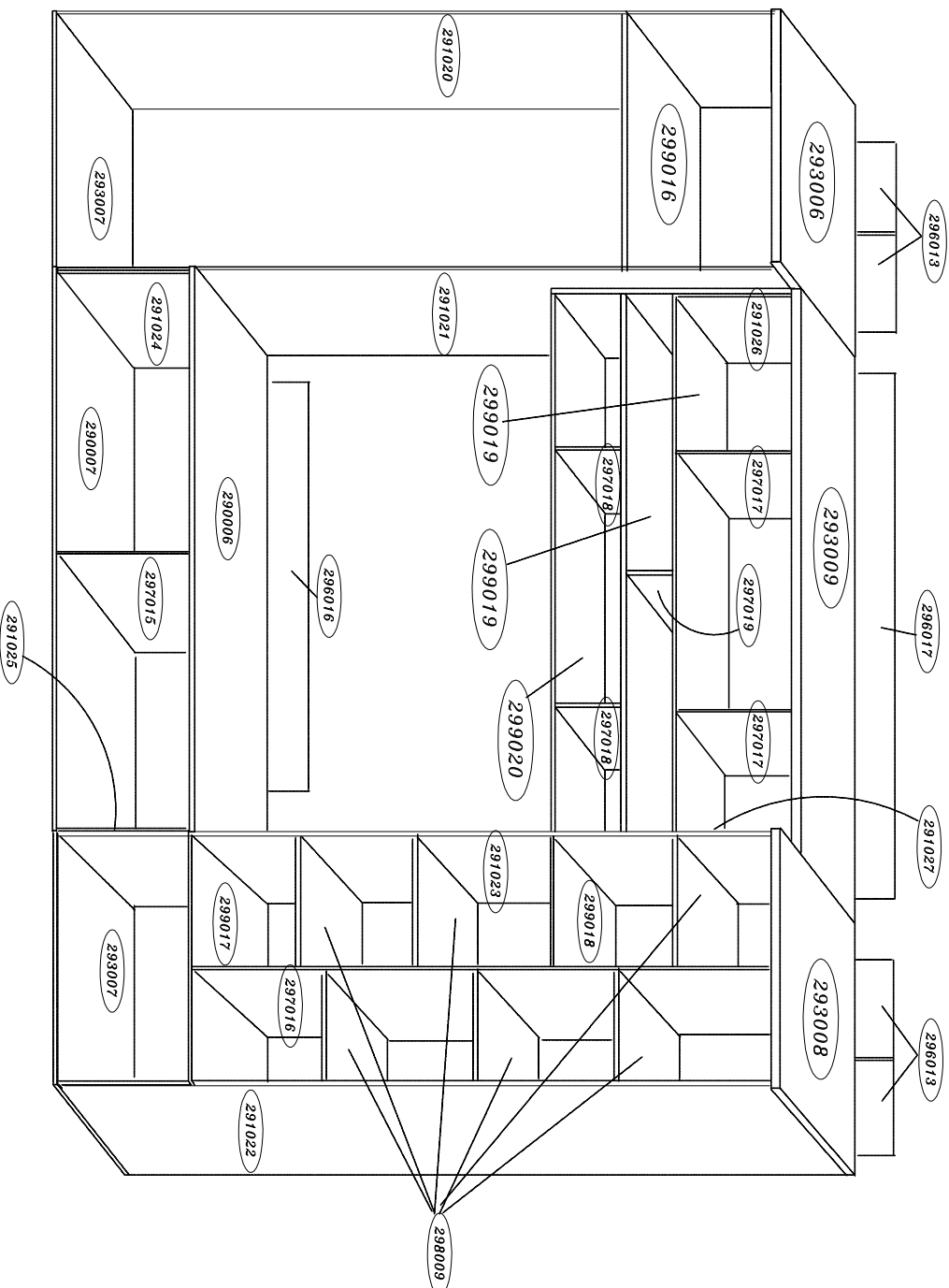





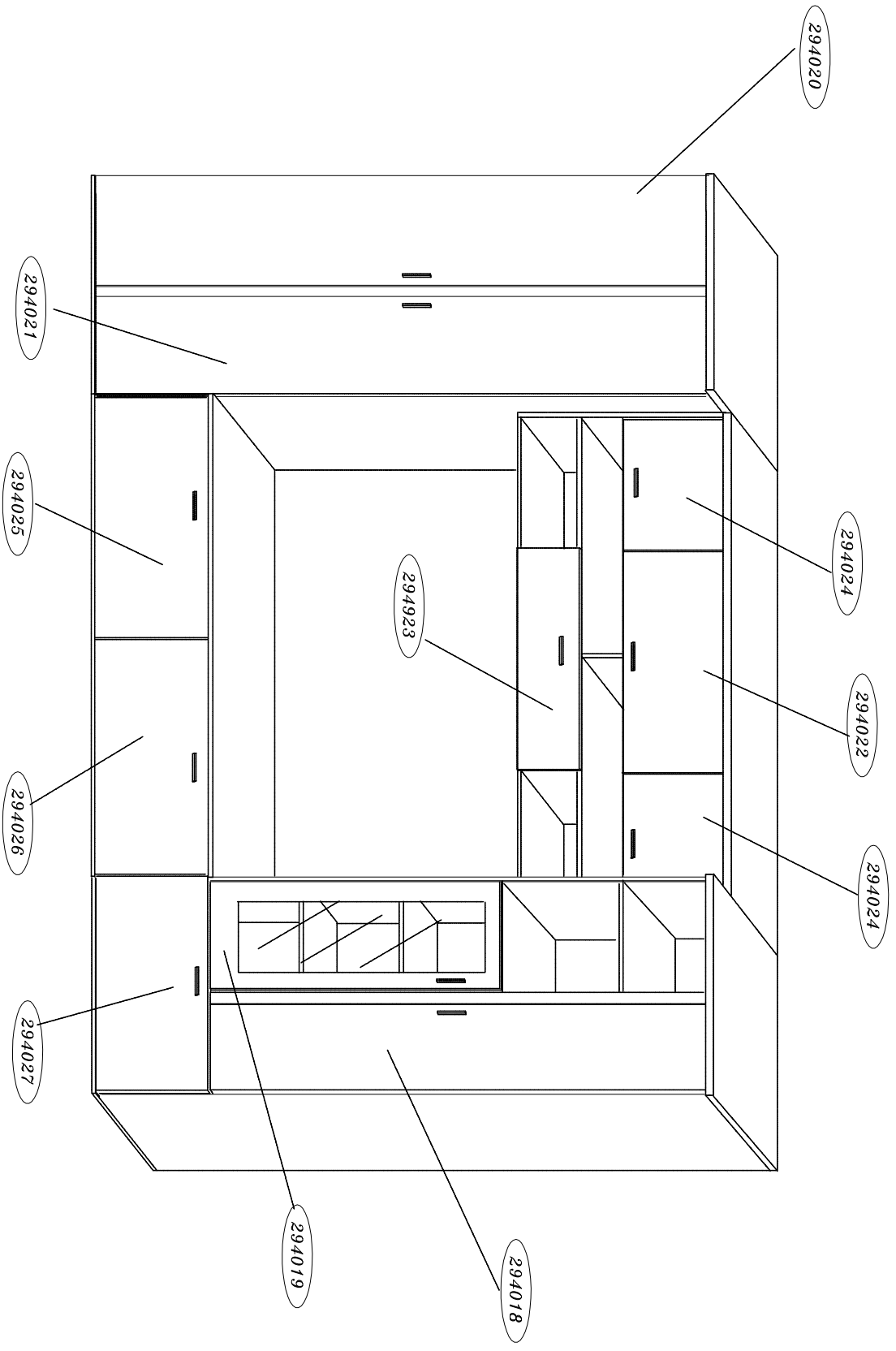









UWAGA!

Zwrot przysięgnięciem do montażu może przetrwać dobitnie ingerencja do a konstrukcji. Umieszczenie
podstawy w innych miejscach może być niebezpieczne dla zdrowia i życia.



SEGMENT 1

- A = 12 SZT 
- B = 12 SZT 
- C = 12 SZT 
- D = 2 SZT 
- E = 6 SZT 
- F = 6 SZT 
- G = 2 SZT 
- H = 50 SZT 
- I = 12 SZT 
- J = 2 SZT  3,5X13
- K = 24 SZT  3,5X16
- L = 4 SZT  4X25
- M = 1 SZT 
- Z = 1 SZT 
- W = 4 SZT 



KROK 1

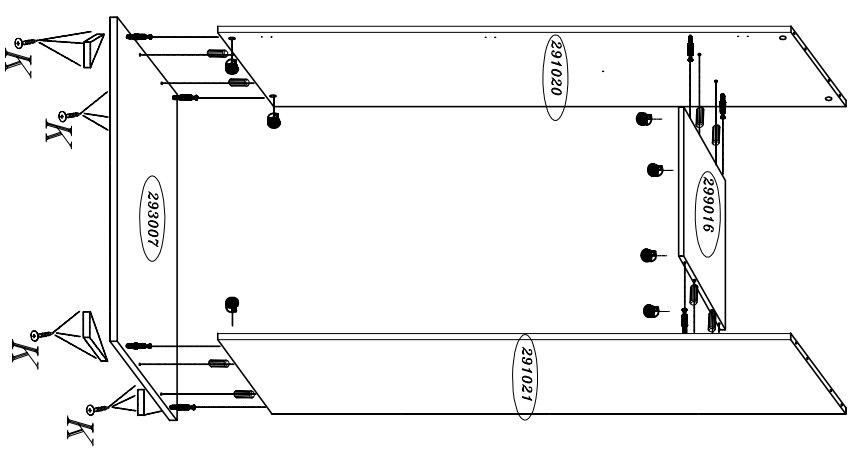

KROK 2

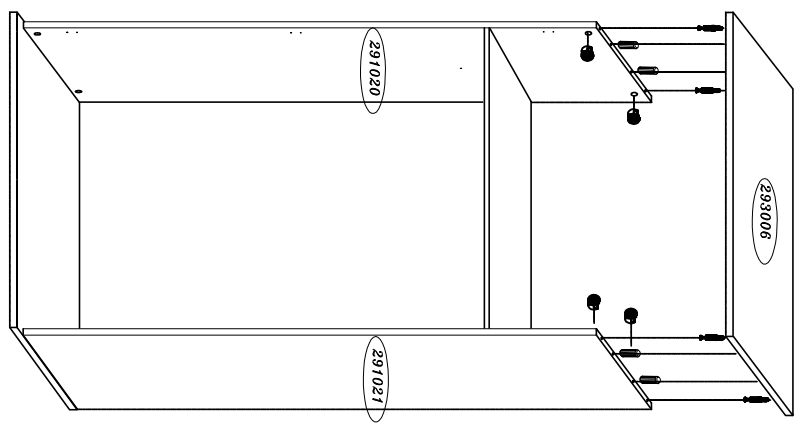

KROK 3

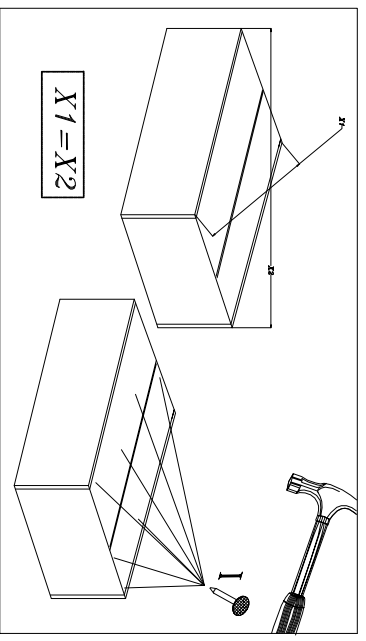
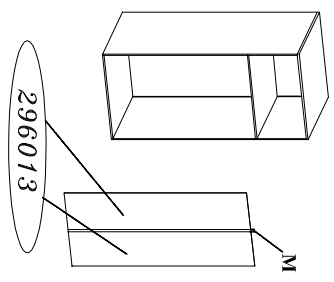
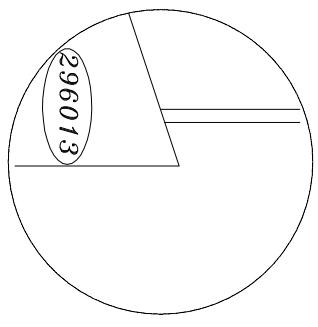
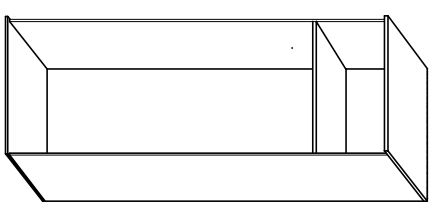

KROK 4

III

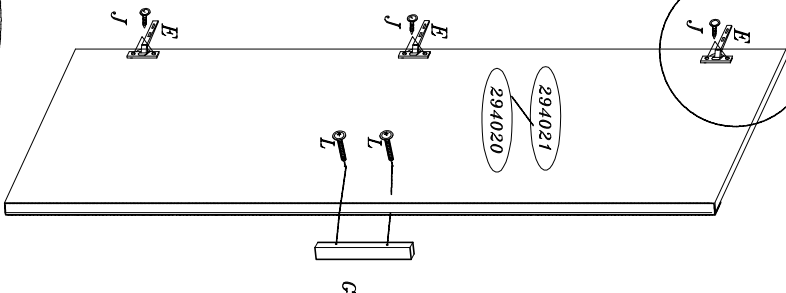
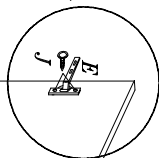
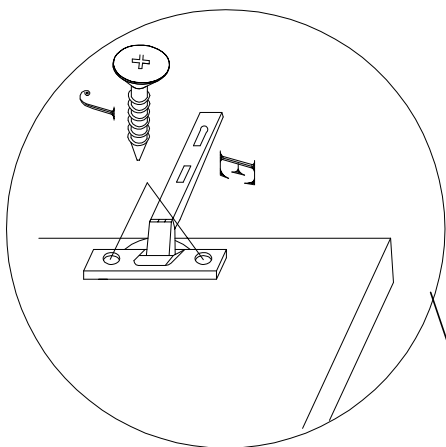
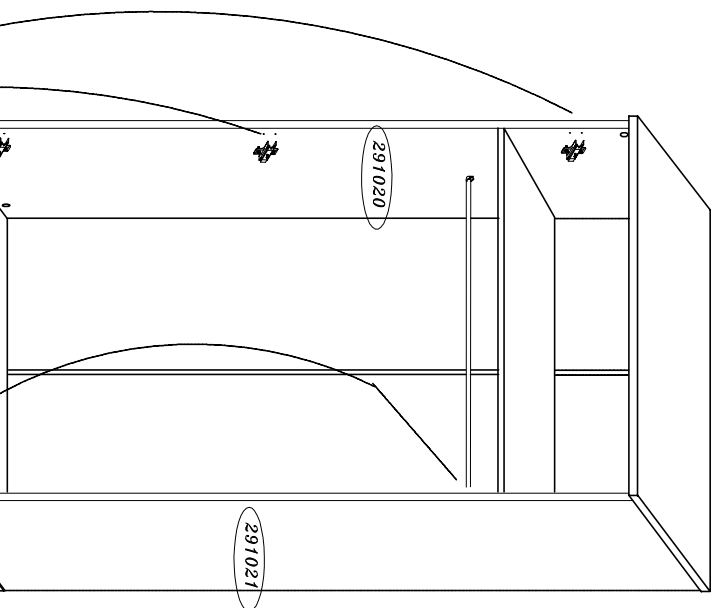

I

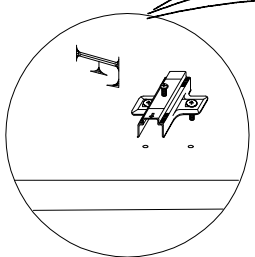

II

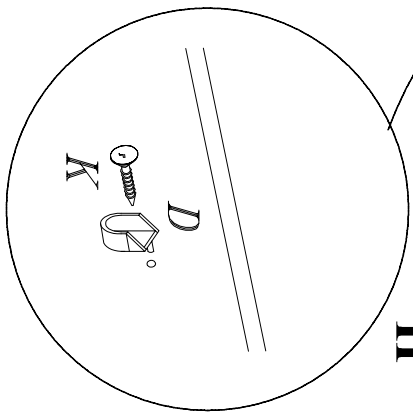



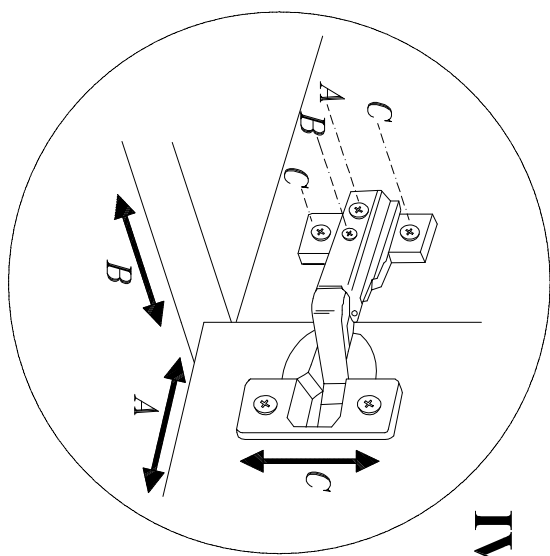











IV



SEGMENT 2

KROK 5

- A = 16 SZT 
- B = 16 SZT 
- C = 16 SZT 
- D = 8 SZT 
- E = 2 KPL 
- F = 2 SZT 
- G = 40 SZT 
- H = 16 SZT 
- I = 30 SZT 
- J = 12 SZT 
- K = 4 SZT 
- L = 2 SZT 
- Z = 1 SZT 
- W = 6 SZT 



KROK 6

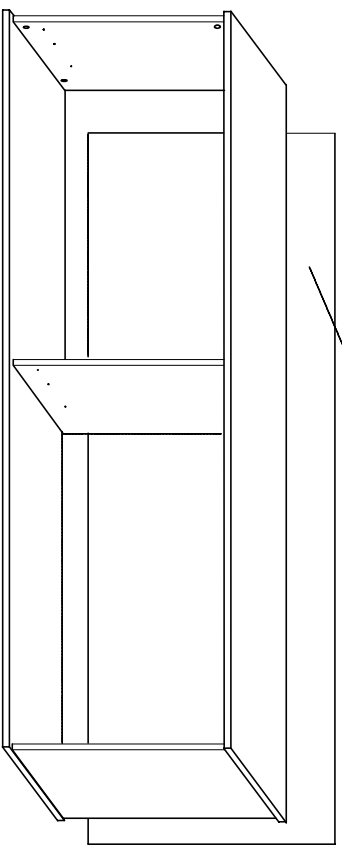

296016

KROK 7

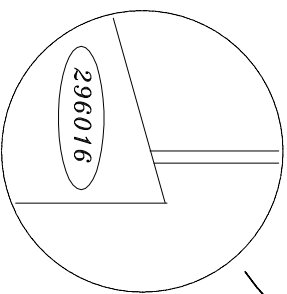
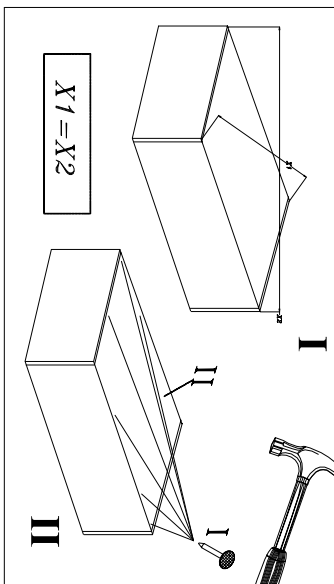
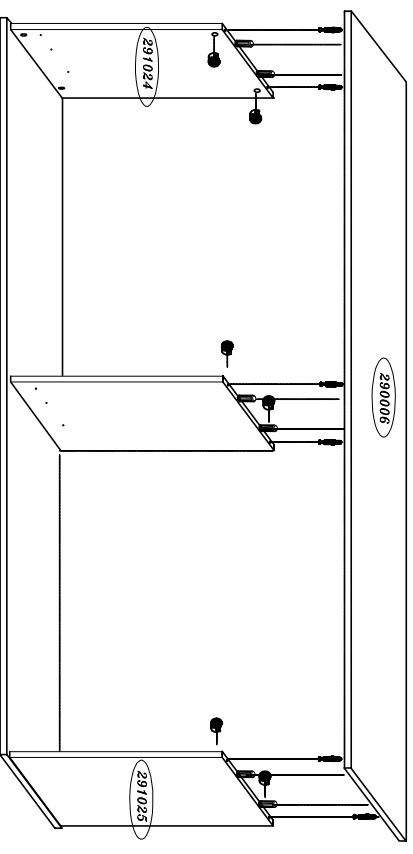

KROK 8

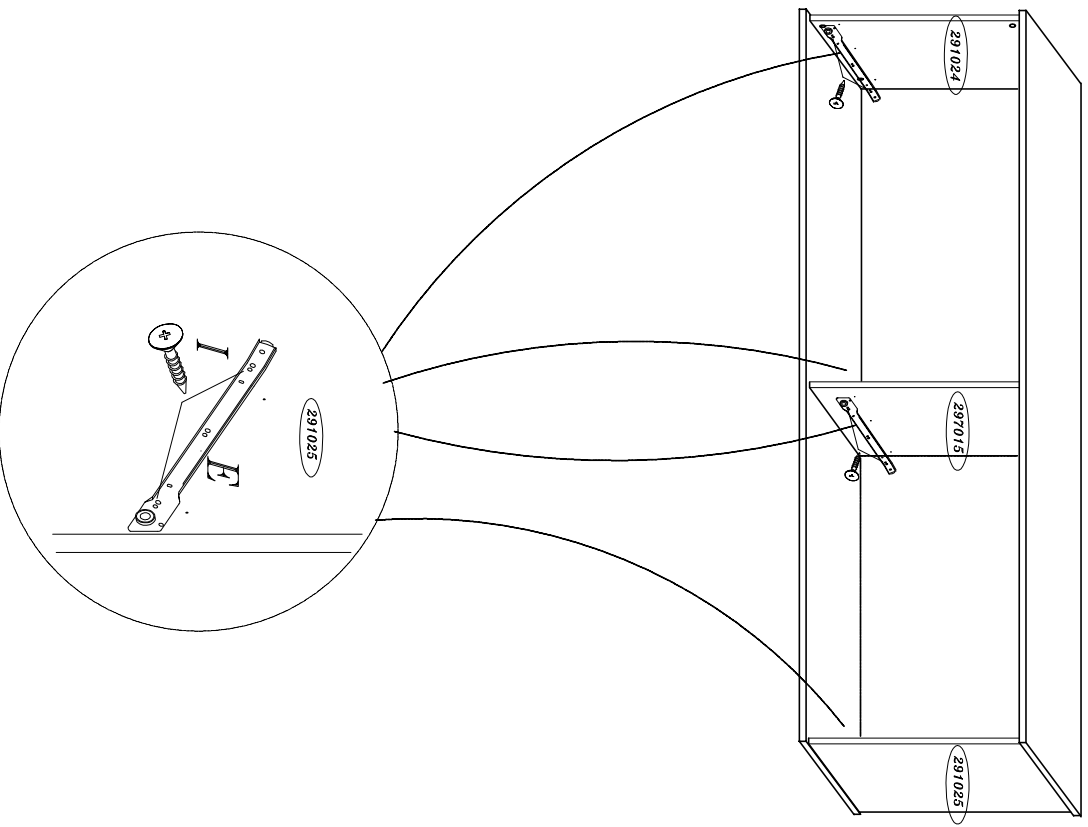

KROK 9

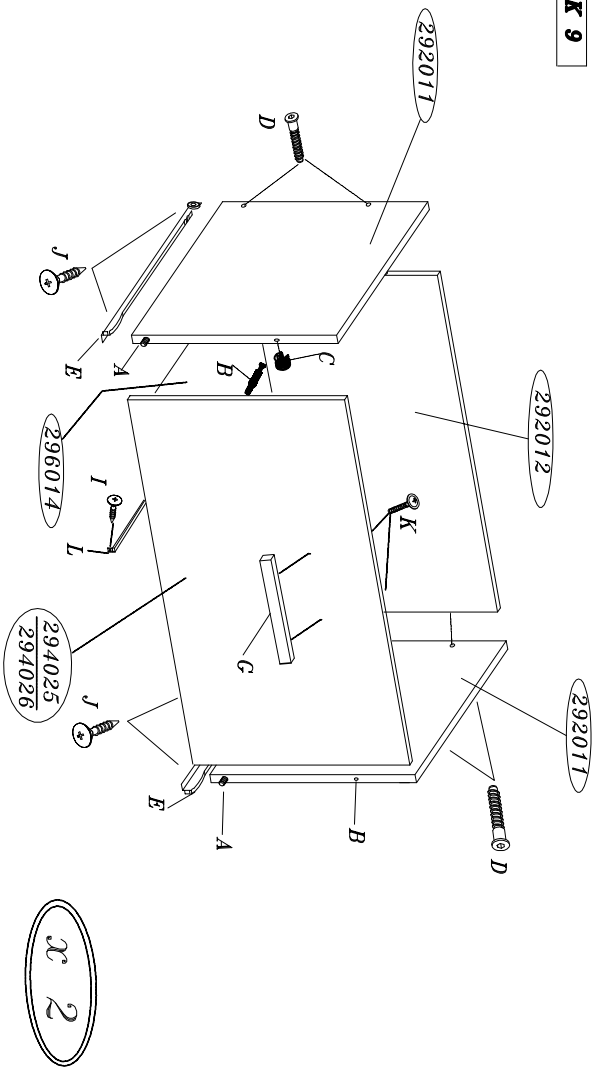



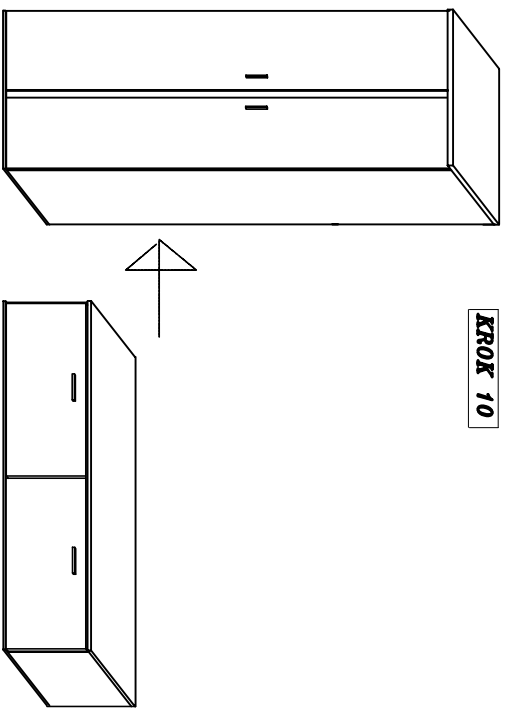











KROK 10



2 2

SEGMENT 3

- | | | | | | | | | | | | | | | | | | | | | | | | | | | | |
|------------|---|------------|---|------------|---|-----------|---|-----------|---|------------|---|-----------|---|-----------|---|------------|---|------------|--|-----------|---|-----------|---|----|---|----|---|
| A = 32 SZT |  | B = 32 SZT |  | C = 32 SZT |  | D = 4 SZT |  | E = 6 SZT |  | E1 = 2 SZT |  | F = 8 SZT |  | G = 4 SZT |  | H = 40 SZT |  | I = 16 SZT |  | J = 4 SZT |  | Z = 1 SZT |  | B1 |  | B1 |  |
|------------|---|------------|---|------------|---|-----------|---|-----------|---|------------|---|-----------|---|-----------|---|------------|---|------------|--|-----------|---|-----------|---|----|---|----|---|
- 3,5X16
4X25
B1 = 4 KPL



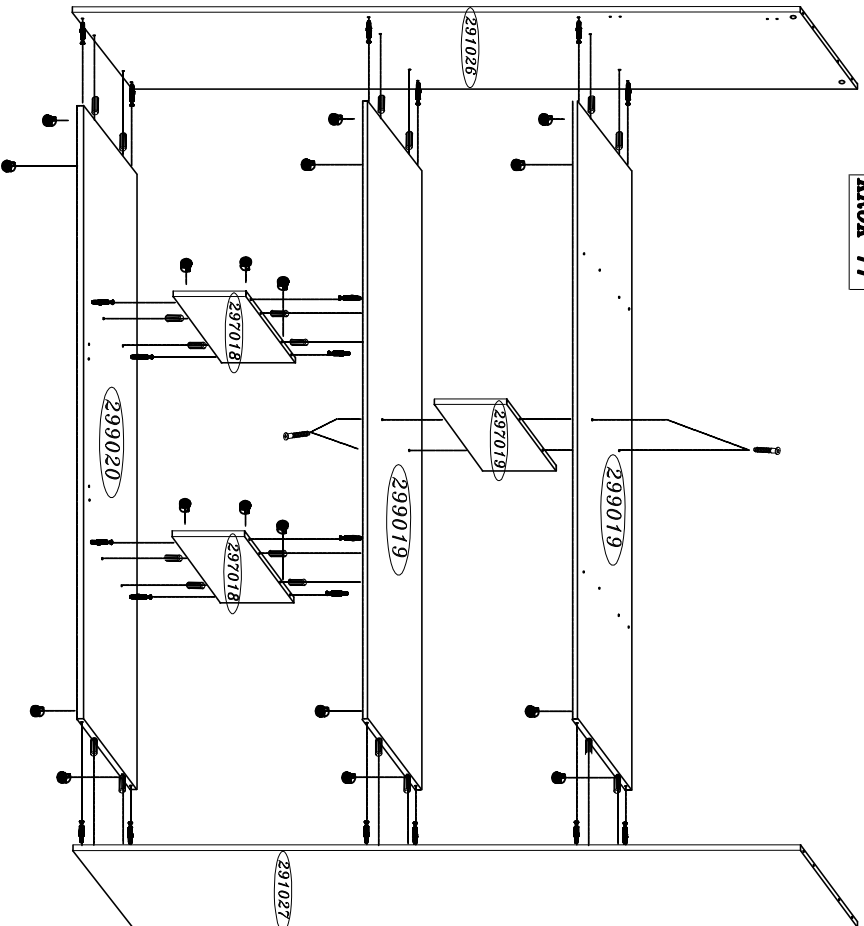



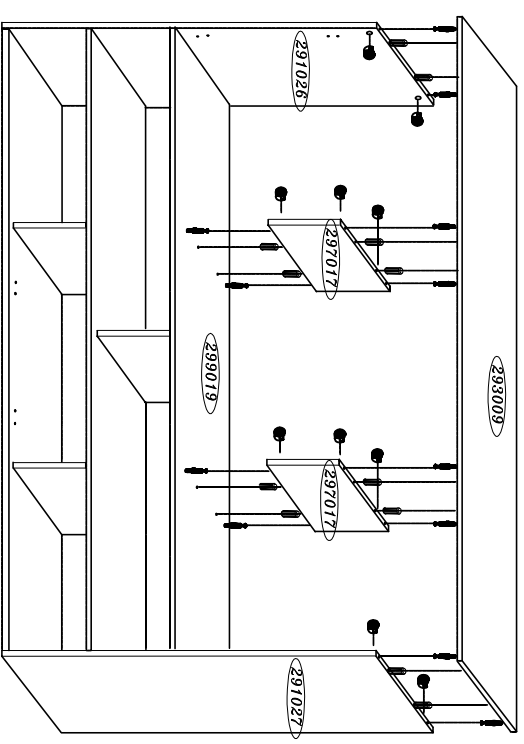











KROK 11



KROK 12



SEGMENT 4

- A = 22 SZT 
- B = 22 SZT 
- C = 22 SZT 
- D = 4 SZT 
- E = 1 KPL 
- F = 24 SZT 
- G = 3 SZT 
- H = 40 SZT 
- I = 22 SZT 
- J = 3,5x16 
- K = 3x25 
- L = 4x25 
- M = 8 SZT 
- N = 1 SZT 
- O = 5 SZT 
- P = 5 SZT 
- Z = 1 SZT 
- W = 4 SZT 



KROK 14

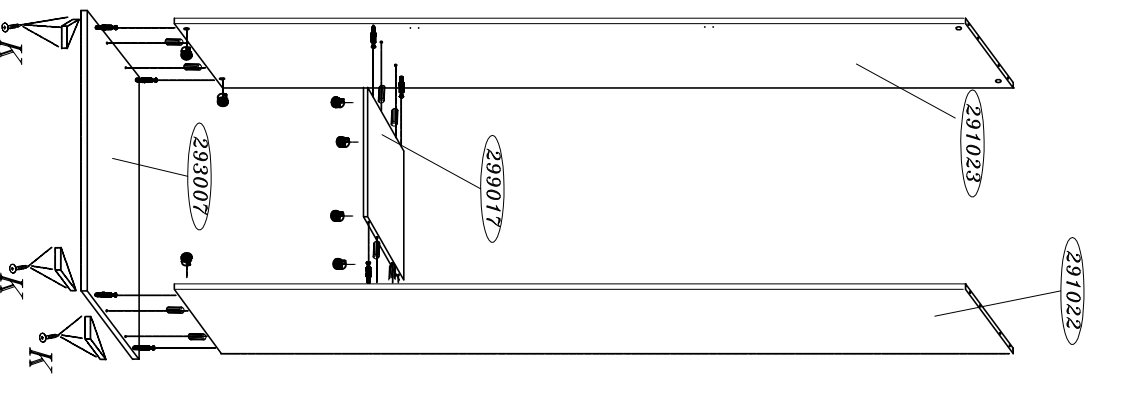

KROK 15

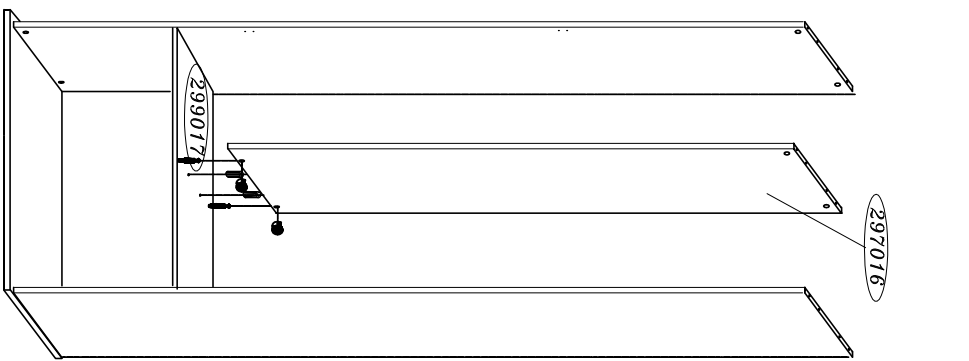

KROK 16

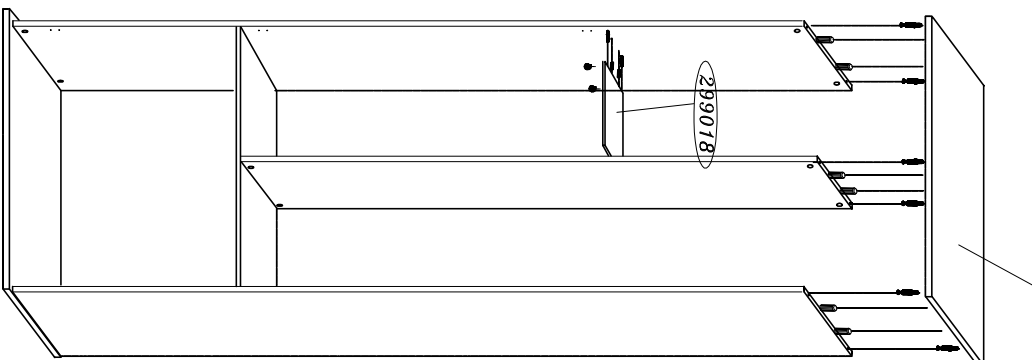

KROK 17

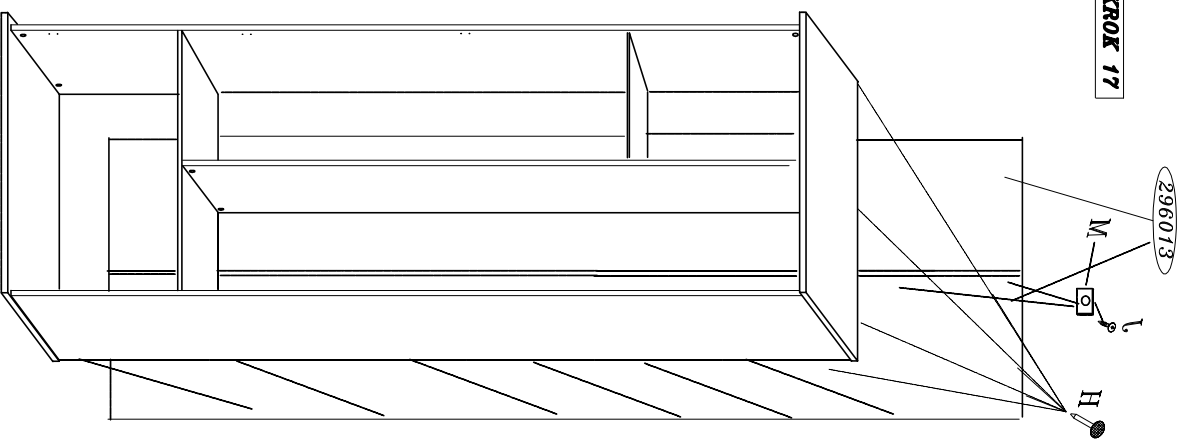

KROK 18

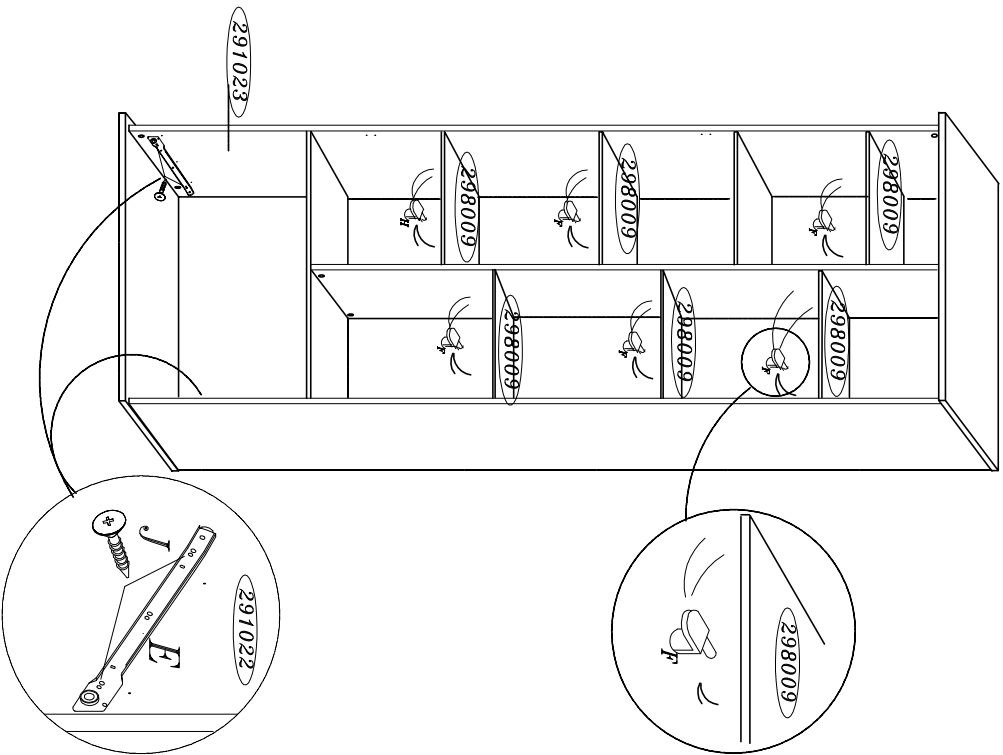

KROK 19

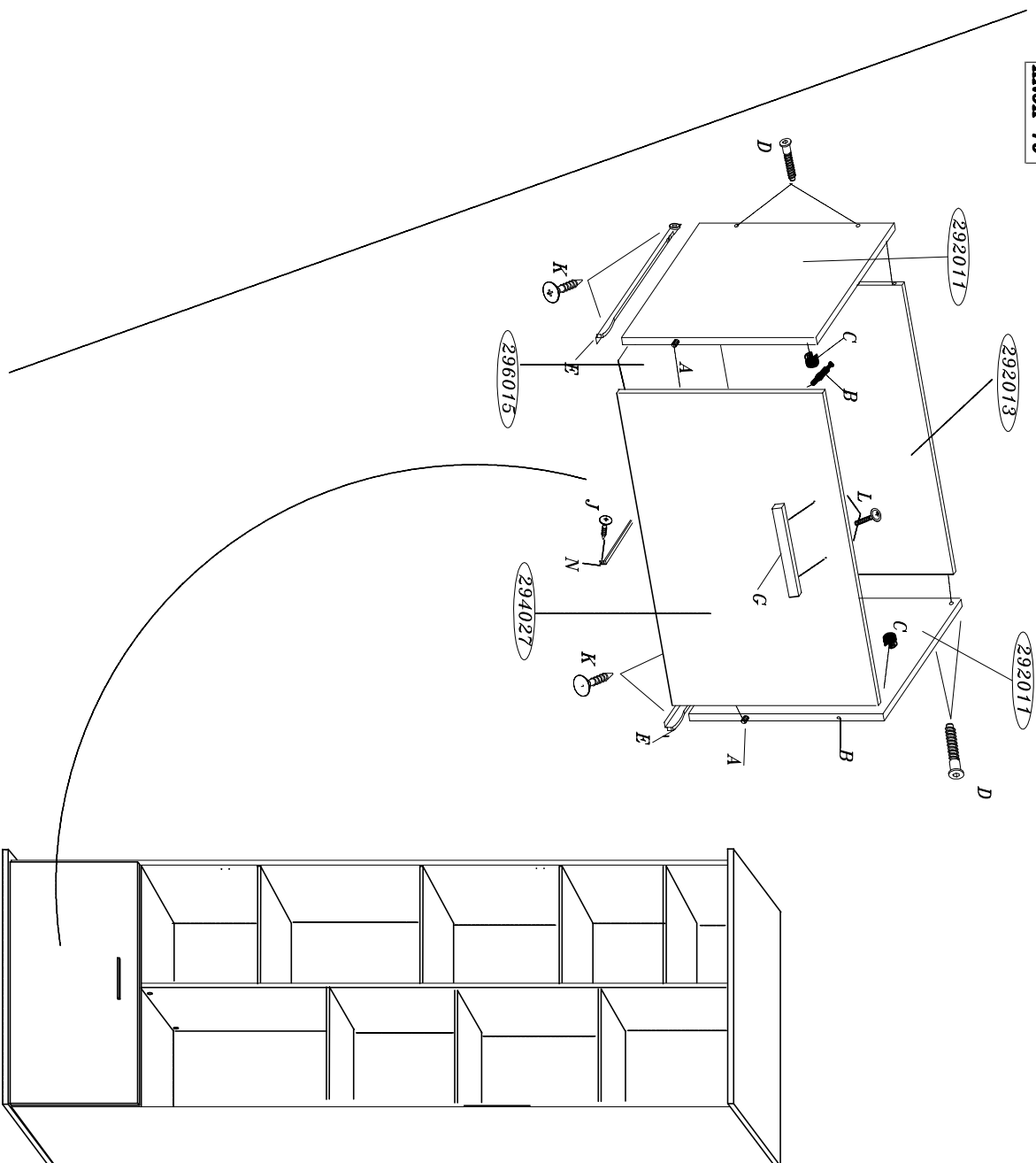

KROK 20

I

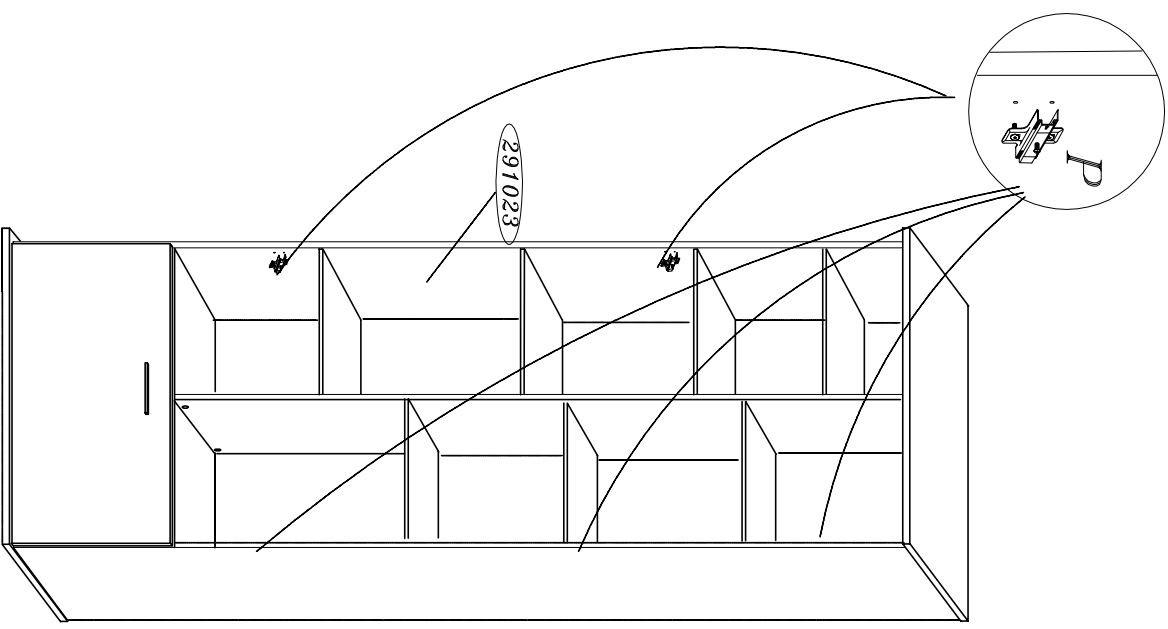

II

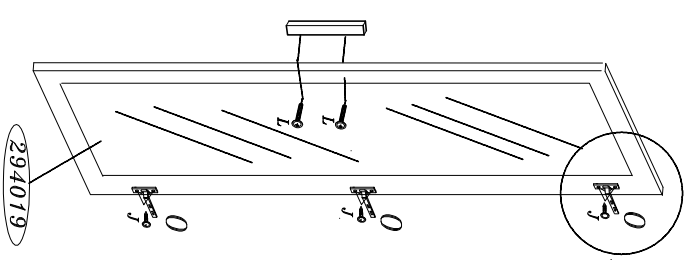

III

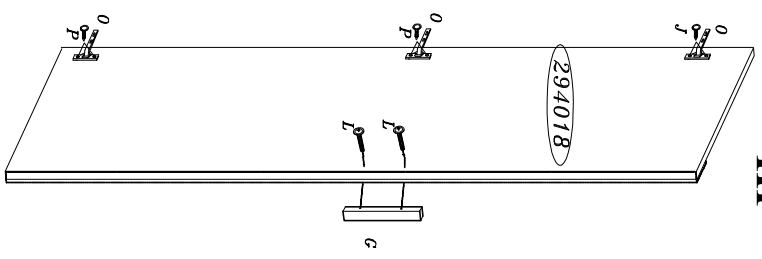

IV

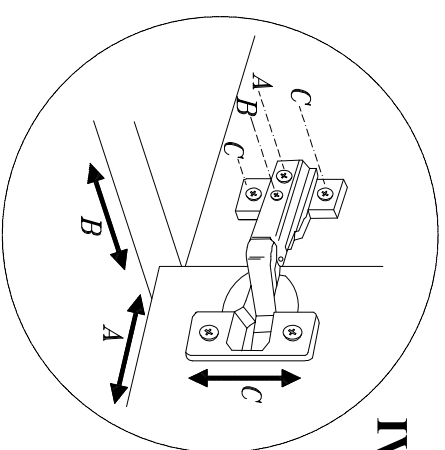

KROK 21

SCHEMAT POŁĄCZENIA NADSTAWKI

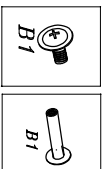
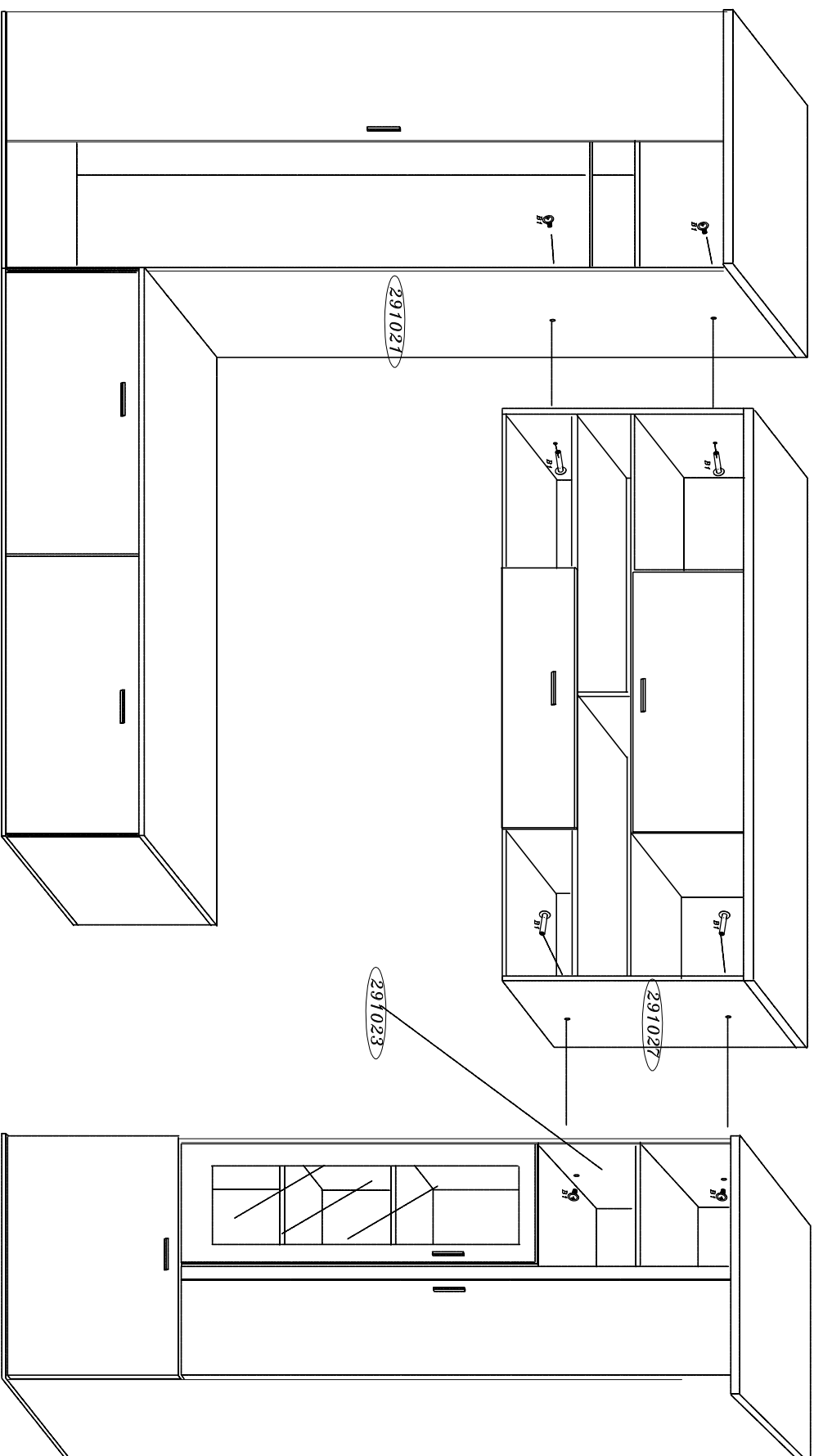

B1 = 4szt.