

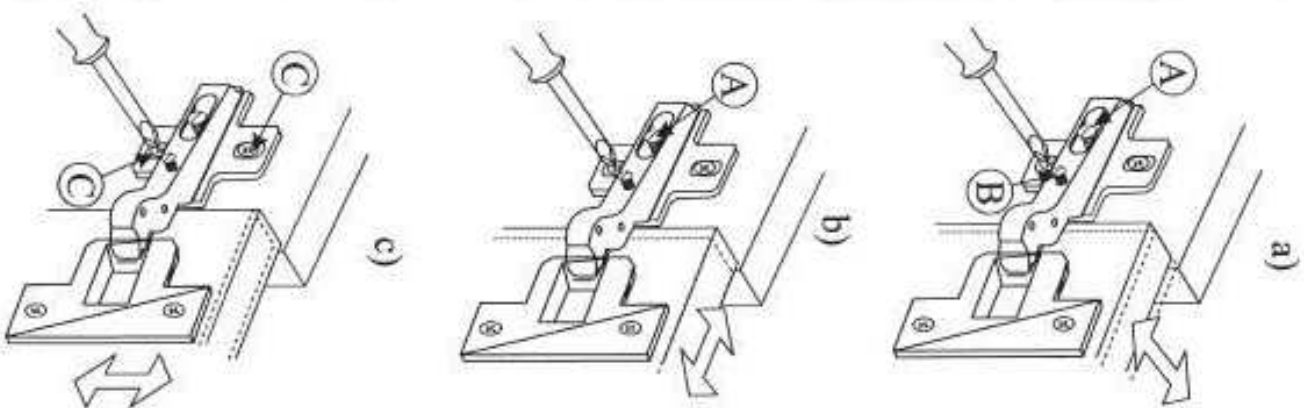

Modelname: **LOGO**  
 Nazwa modelu:

Modelreihe: **29 EMLU** Type: **93**  
 Numer modelu: Type:

strana

7 von: 7  
z:

Montáž závesov

Regulácie závesov

a) regulácia medzery: postupne uvoľňujeme skrutku „A“ a skrutkou „B“ nastavujeme požadovanú medzeru. Po nastavení potrebnej medzery dotiahneme skrutku „A“ na pevno.

b) regulácia hĺbky: uvoľňujeme skrutku „A“, ktorou zároveň nastavíme požadovanú hĺbku závesu. Následne skrutku „A“ dotiahneme.

c) regulácia výšky: uvoľňujeme skrutku „C“ pokiaľ nedosiahneme potrebnú výšku závesu. Následne skrutku „C“ dotiahneme.

Modellname: **LOGO**  
 Název modelu:

Modelreihe: **29 EMILIO** Typ: **20**  
 číslo modelu

Blatt Nr **1** von: **7**  
 strana z:

# MONTAGEANLEITUNG INSTRUKCJA MONTAŻOWA

## Montážny návod

**Pflegehinweis!**  
 Bitte nur mit einem Staubtuch oder einem feuchten Lappen reinigen.  
**KEINE** scheuernde Putzmittel verwenden!

Príprava  
 Pred samotnou montážou sa dôkladne oboznámte s montážnym návodom!  
 Poškodenia vznikajúce nesprávnomu montážu sú vylúčené z reklamácií.  
 Ak pri montáži zistíte poškodené alebo chýbajúce prvky, opíšte z montážneho návodu číslo elementu.

**UPOZORNENIE!**  
 Prosíme šikrný uterák, prachovkú alebo vlnku handričkou. Nepoužívať agresívne čistiace prostriedky!

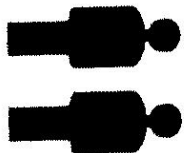

**2 Personen  
 2 Osoby**

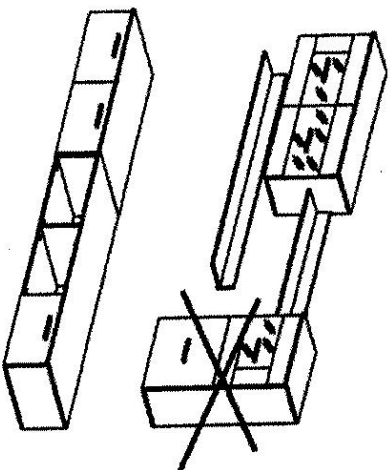
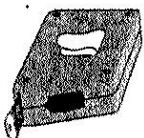

Max. zulässige Belastungen  
 von Einlegeböden in kg:  
 Maksymálne obťaženie póltek w kg:

Länge/Dl. mm	Stärke/Gr.	Spannplatte/Pyta	Glas/Szklko
0<400	15	18	22
401<600	40	40	40
601<800	24	24	40
801<1000	15	30	900 mm/10kg

Maximálne prípustné  
 zatváženie pólčiek

hrúbka	hrúbka	hrúbka
dĺžka	mm	mm
0<400	15	18
401<600	40	40
601<800	24	40
801<1000	15	30

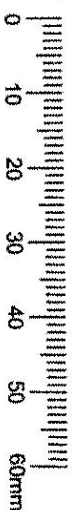
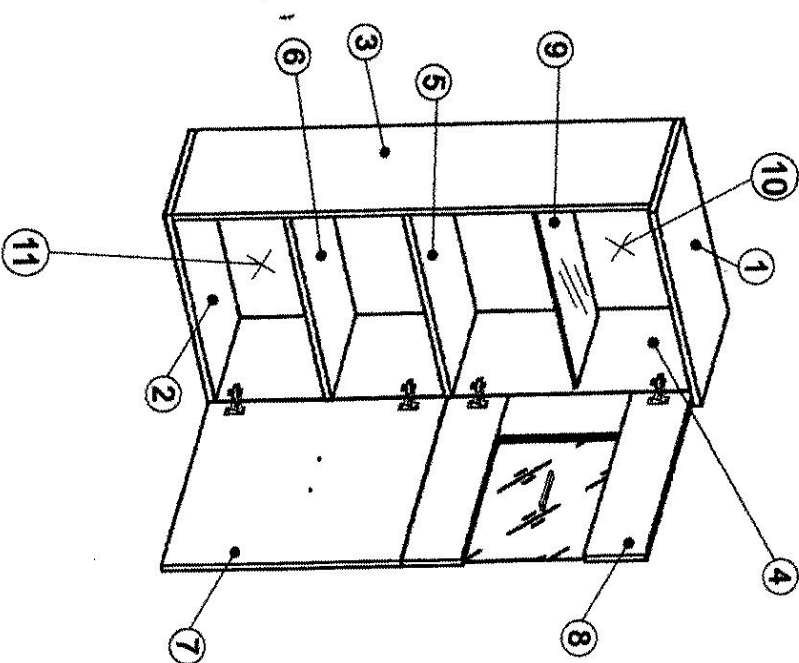

Názov modelu

Modelname: **LOGO**

Modellreihe: **29 FM LO**











Type: **20**





Blatt Nr. **2** von: **7**







strana





Z:

# BESCHLAGLISTE WYKAZ OKUĆ

NR 1	
<b>B1</b>  4.8x28 X12	
<b>M1</b>  X8	
<b>T1</b>  X8	
<b>W2</b>  X4	
<b>W1</b>  X4	
<b>L1</b>  16g X1	
<b>U23</b>  X6	
<b>C2</b>  X8	
<b>F1</b>  X5	
<b>S5</b>  2.5x16 X5	

NR 2	
<b>Y0</b>  435 X4	
<b>S8</b>  4x13 X8	
<b>Y5</b>  X4	
<b>E3</b>  6.3x13 X8	
<b>C3</b>  Ø5 X8	

NR 3	
<b>U34</b>  L=148/Re=128 L=148 X2	
<b>P6</b>  3.5x30 X2	
<b>P19</b>  3.5x20 X2	
<b>G4</b>  X2	
<b>T10</b>  4x40 X2	
<b>B8</b>  X1	

NR 4	
<b>K1</b>  7x50 X4	
<b>G2</b>  X1	
<b>T17</b>  X2	
<b>S4</b>  4x30 X4	

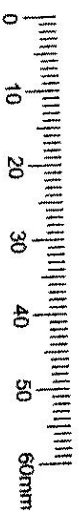

Modelname: **LOGO**

Modelreihe: **29 EMILIO** Type: **30**

Blatt Nr **1** von: **6**  
strana Z.

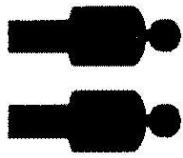

**2 Personen**  
**2 Osoby**

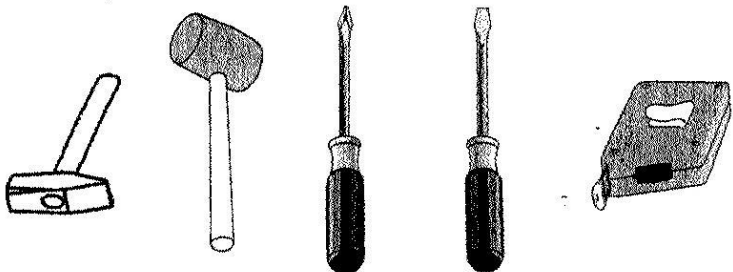

**Pflegehinweis!**  
Bitte nur mit einem Staubtuch oder einem feuchten Lappen reinigen.  
**KEINE** scheuernde Putzmittel verwenden!

**MONTAGEANLEITUNG**  
**INSTRUKCJA MONTAŻOWA**

**Montážny návod**

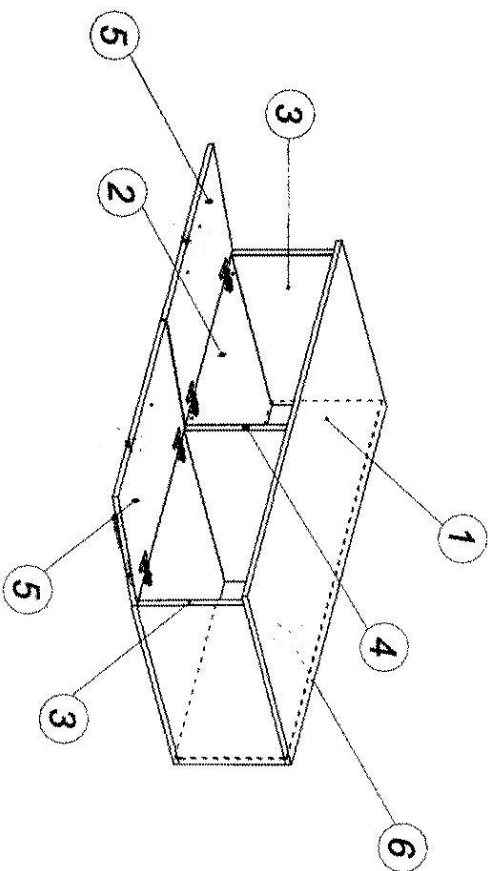
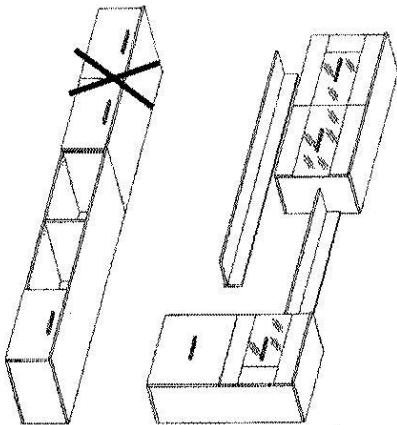

Max. zulässige Belastungen  
von Einlegeböden in kg:

Stärke/Gr.	Spannplatte/Pyta	Glas/Szklo
0-400	15	18
401-600	40	40
601-800	24	40
801-1000	15	30

Länge/Dl./mm	Spannplatte/Pyta	Glas/Szklo
0-400	15	18
401-600	40	40
601-800	24	40
801-1000	15	30

Max. permissible load per shelf in kg

Stärke/Gr.	Spannplatte/Pyta	Glas/Szklo
0-400	15	18
401-600	40	40
601-800	24	40
801-1000	15	30

Länge/Dl./mm	Spannplatte/Pyta	Glas/Szklo
0-400	15	18
401-600	40	40
601-800	24	40
801-1000	15	30



Modelname:  
Názov modelu

**LOGO**

Modelreihe: **29 FM LO**  
číslo modelu: :







Type:  
Typ: **30**

Blatt Nr **2** von: **6**  
strana z:





# BESCHLAGLISTE WYKAZ OKUĆ

Obsah kování

**NR 1**

<b>B1</b>  ø 8x28 X12	<b>M1</b>  X12	<b>C2</b>  X12	<b>TT1</b>  X12	<b>J23</b>  X6	<b>L1</b>  16g X1	<b>B3</b>  ø1,4x25 X5
---	---	---	--	---	---	---



**NR 2**

<b>Y0</b>  ø35 X4	<b>S8</b>  4x13 X8	<b>Y5</b>  X4	<b>E3</b>  6,3x13 X8
--	--	--	--

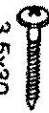
**NR 3**

<b>U34</b>  L=148 L=148/R=128 X2	<b>P6</b>  3,5x30 X4
---	---

**NR 4**

<b>F10</b>  h=25 ø/48 X5	<b>P5</b>  4x25 X5
---	--



Modellname: **LOGO**  
 Nazov modelu:

Modellreihe: **29 EM LO**  
 číslo modelu

Type: **30**  
 Typ:

Blatt Nr **3** von: **6**  
 strana z:

**1**

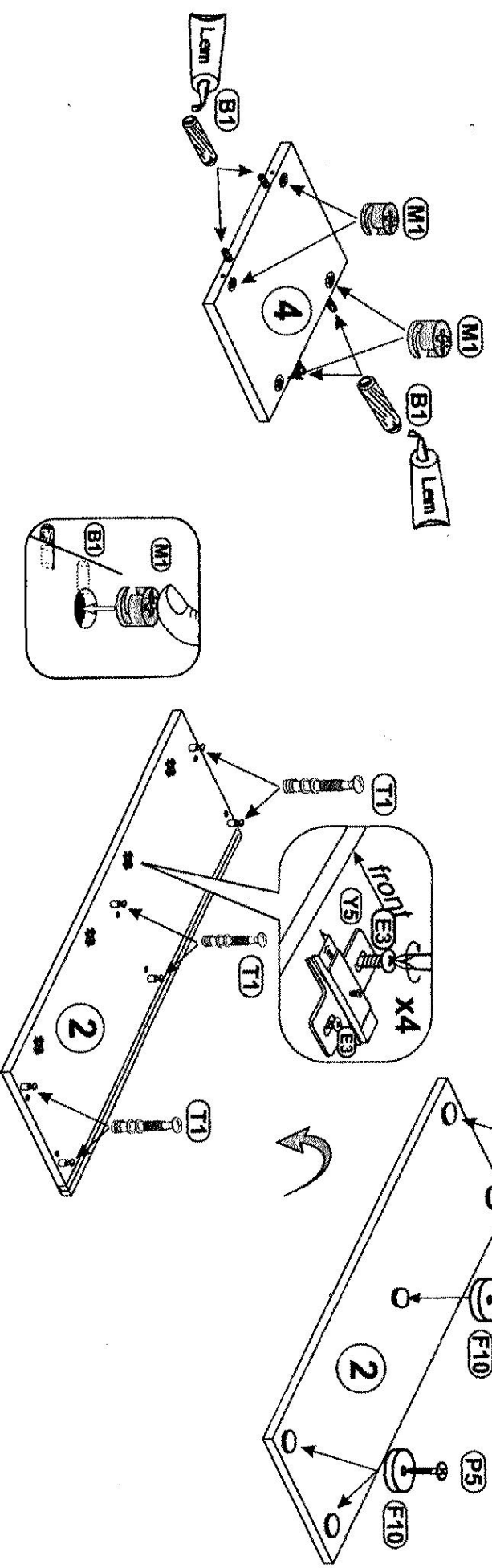
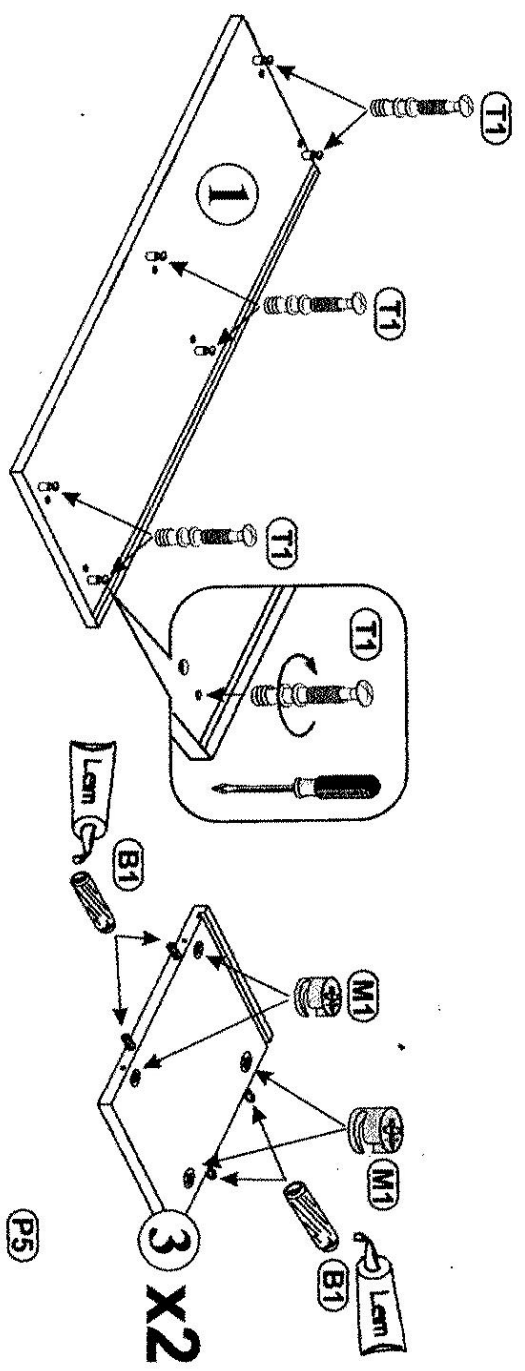

- L1** 10g  
Leim X1
- B1** 8x28 X12
- M1** X12
- T1** X12
- F10** X5
- P5** 4x25 X5
- Y5** X4
- E3** 6.3x13 X8

Modelname: **LOGO**

Názov modelu:

Modelreihe: **29 EM LO**

číslo modelu:

Type: **30**

Typ:

Blatt Nr **4** von: **6**

strana

z:

**2**

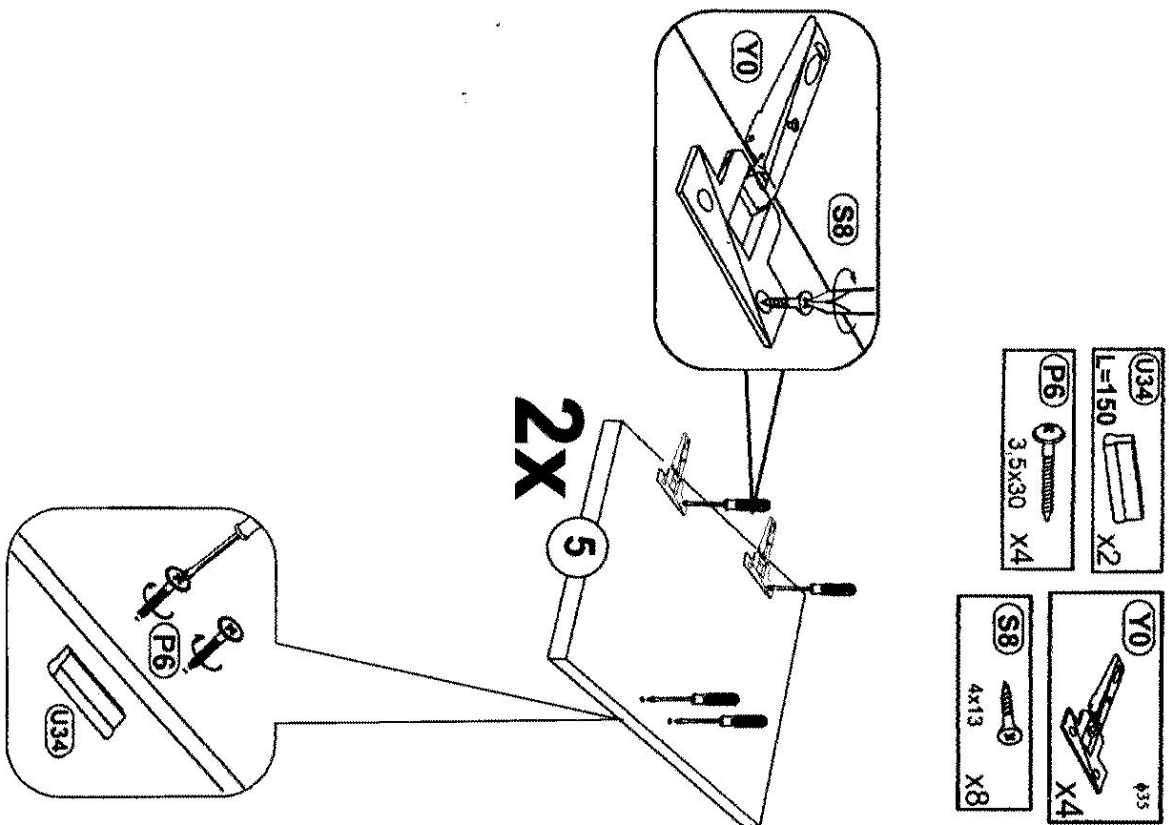

**3**

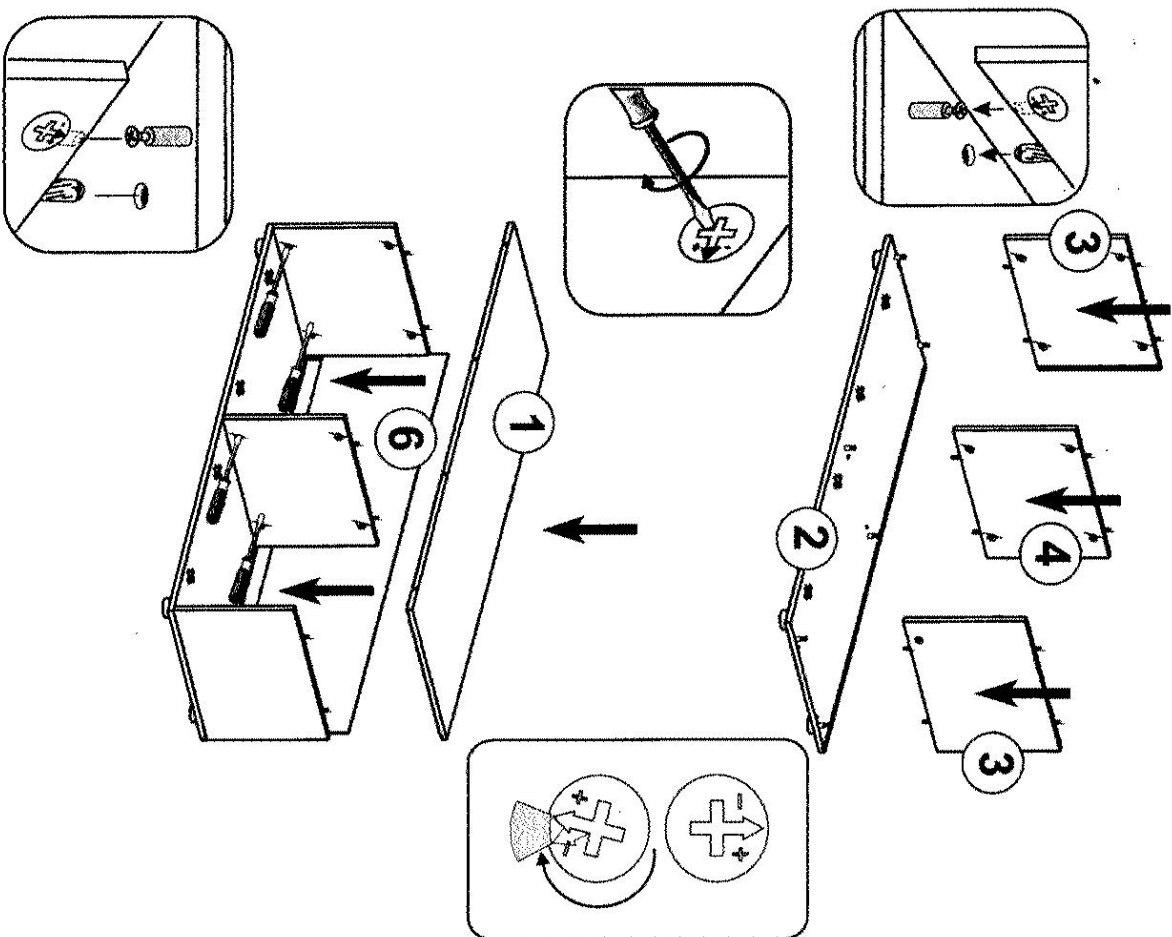



Modelname: **LOGO**  
Nazov modelu :

Modellreihe: **29 EMILIO**  
číslo modelu

Type: **30**  
Typ:

Blatt Nr **5** von: **6**  
strana z:

**4**

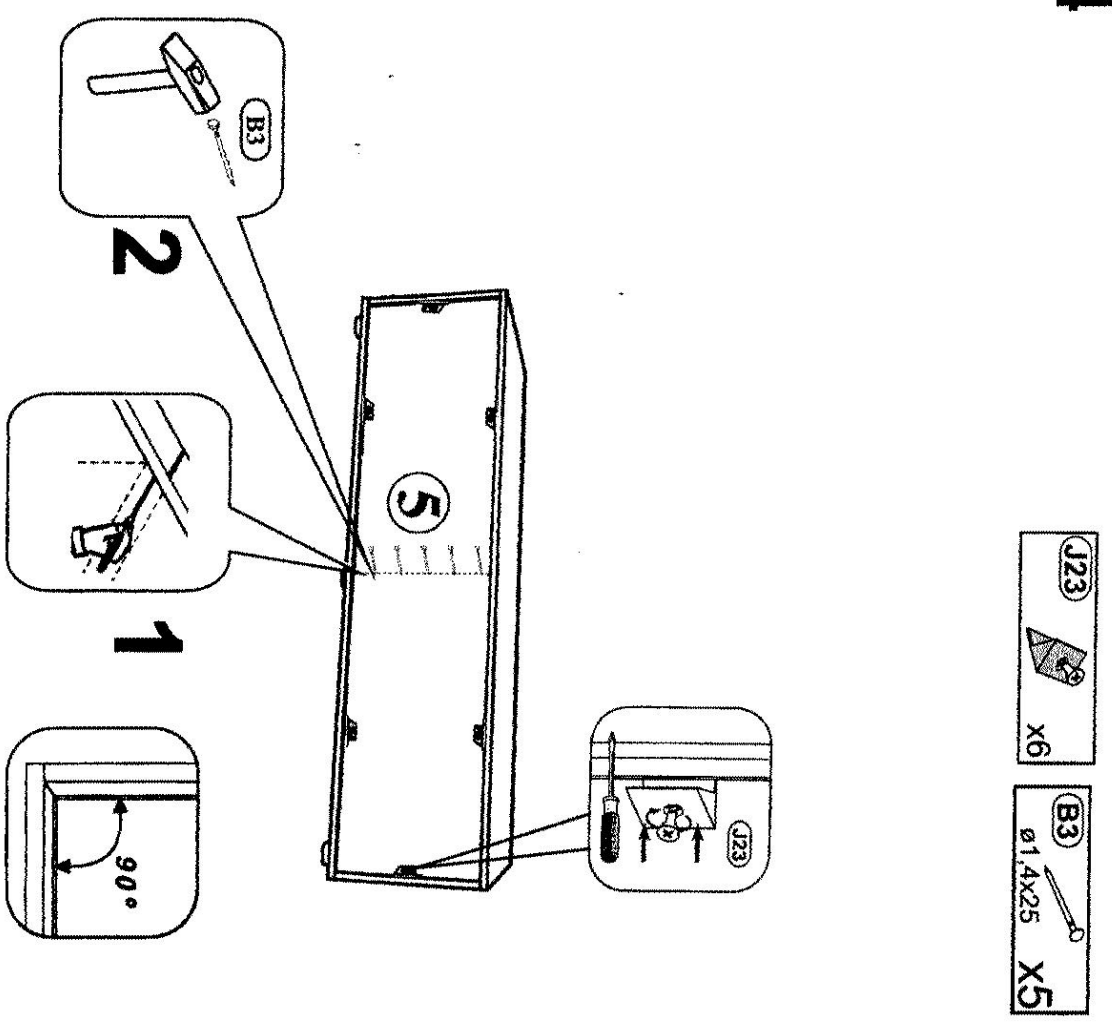

(J23) x6

(B3) ø1,4x25 X5

**5**

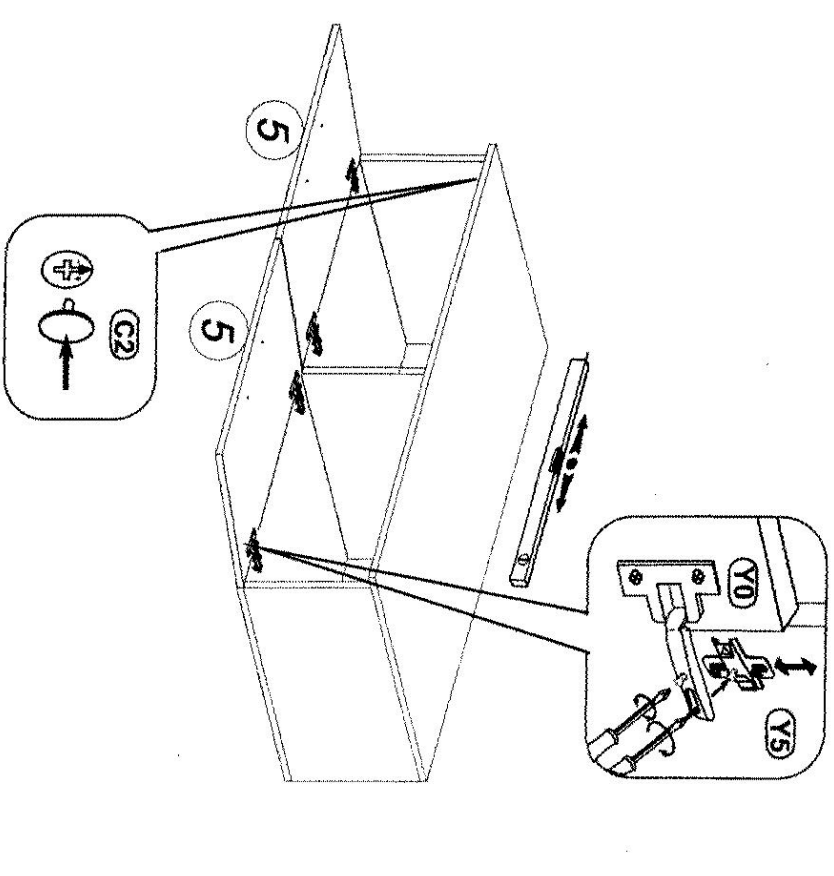

(C2) x12

Modelname:  
 Nazov modelu:

**LOGO**

Modelreihe:  
 číslo modelu

**29 EM LO**

Type:  
 Typ:

**31**

Blatt Nr  
 strana

1 von:  
 6 Z:

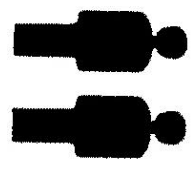

**2 Personen**  
**2 Osoby**

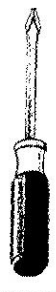

**Pflegehinweis!**

Bitte nur mit einem Staubtuch oder einem feuchten Lappen reinigen.  
**KEINE** schleurende Putzmittel verwenden!

Pezer!

Montážny návod

Nedodržanie postupu pri montáži môže spôsobiť znehodnotenie výrobku.

**MONTAGEANLEITUNG**  
**INSTRUKCJA MONTAŻOWA**

**Montážny návod**

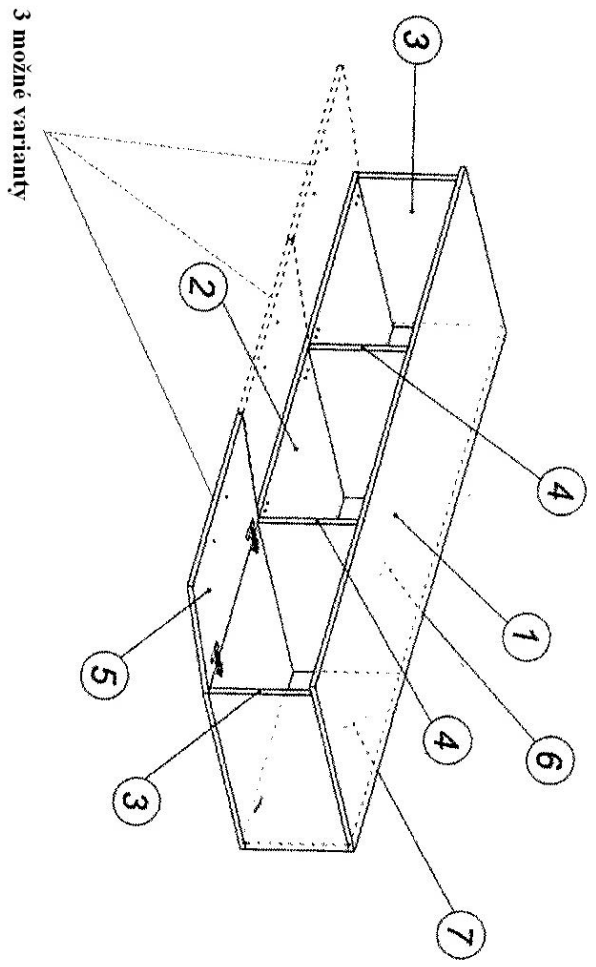
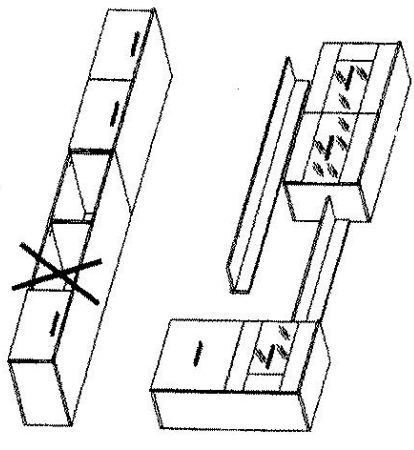

3 možné varianty

Maximálne prípustné zaťaženie políciek

Max. zulässige Belastungen von Einlegeböden in kg:

Maksymalne obciążenie półek w kg:

Stärke/Gf	Spannplatte/Plyta	Glas/Szkló		
Länge/Dl. mm	15	18	22	Länge bis 5/6
0<400				
401<600	40	40	40	Länge bis 600 mm/15kg
601<800	24			Länge bis 900 mm/10kg
801<1000	15	30		

Dicke	Höhe		
	15 mm	18 mm	22 mm
0-400	15	18	22
401-600	40	40	40
601-800	24		
801-1000	15	30	

Modelname: **LOGO**  
Nazov modelu:









Modelreihe: **29 EM LO**  
číslo modelu: Type: **31**  
Typ:

Blatt Nr **2** von: **6**  
Z:  
strana







# BESCHLAGLISTE

Obsah kovania



**NR 1**

- B1**   $\phi$  8x28 X16
- M1**  X16
- C2**  X16
- T1**  X16
- F1**  X3
- S5**  2.5x16 X3
- J23**  X6
- L1**  16g X1



**NR 2**

- Y2**  435 X2
- S8**  4x13 X4
- Y5**  X2
- E3**  6.3x13 X4
- C3**   $\phi$  5 X8
- B3**   $\phi$  1.4x25 X5

**NR 3**

- U34**  L=148/R=128 X1
- P6**  3.5x30 X2
- C4**   $\phi$  40 X3

**NR 4**

- F10**   $\phi$  48 h=25 X8
- P5**  4x25 X8



Modelname:  
Názov modelu:

**LOGO**

Modelreihe:  
číslo modelu

**29 EM LO**

Type:  
Typ:

**31**

Blatt Nr  
strana

**5** von: **6**  
z:

**4**

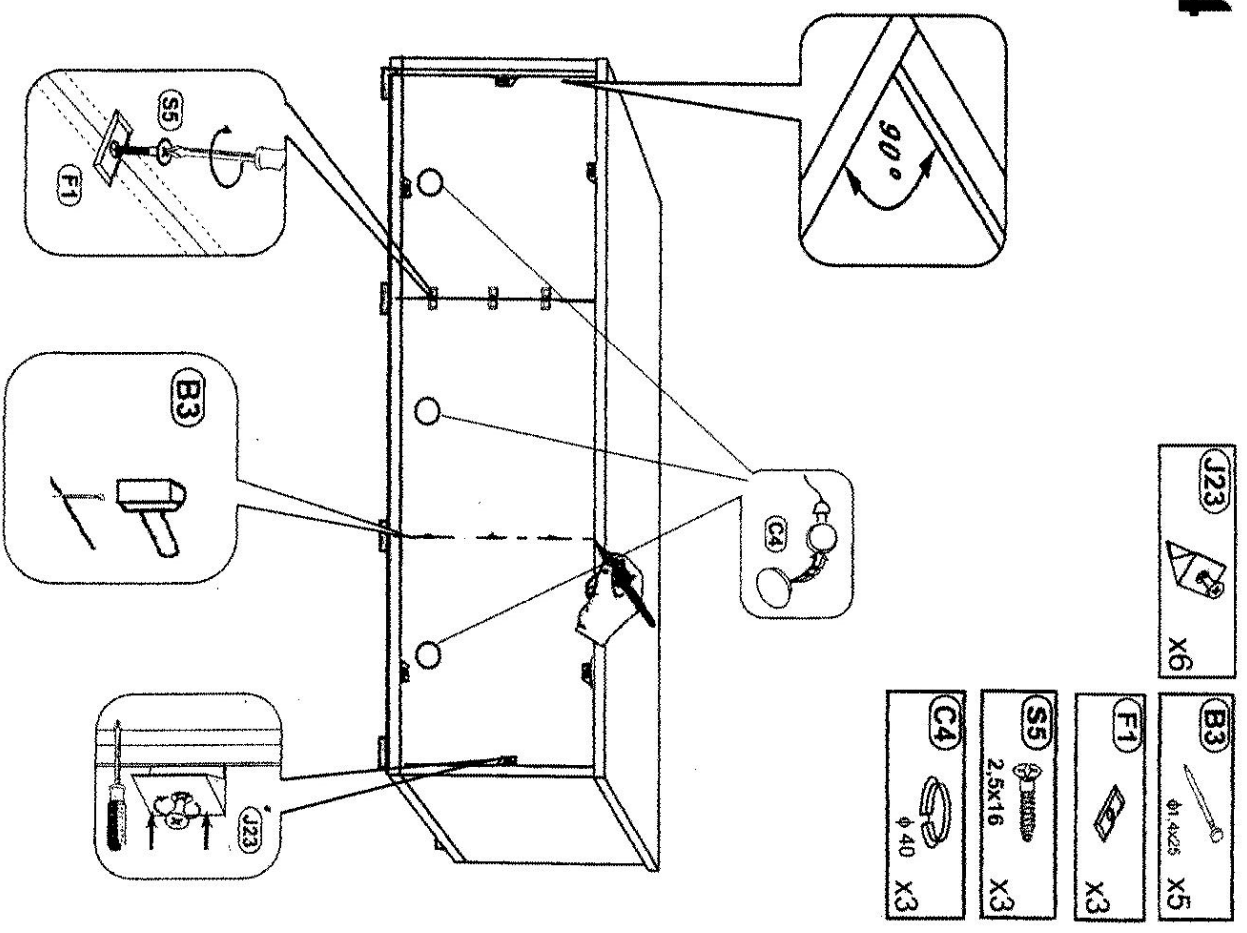

**5**

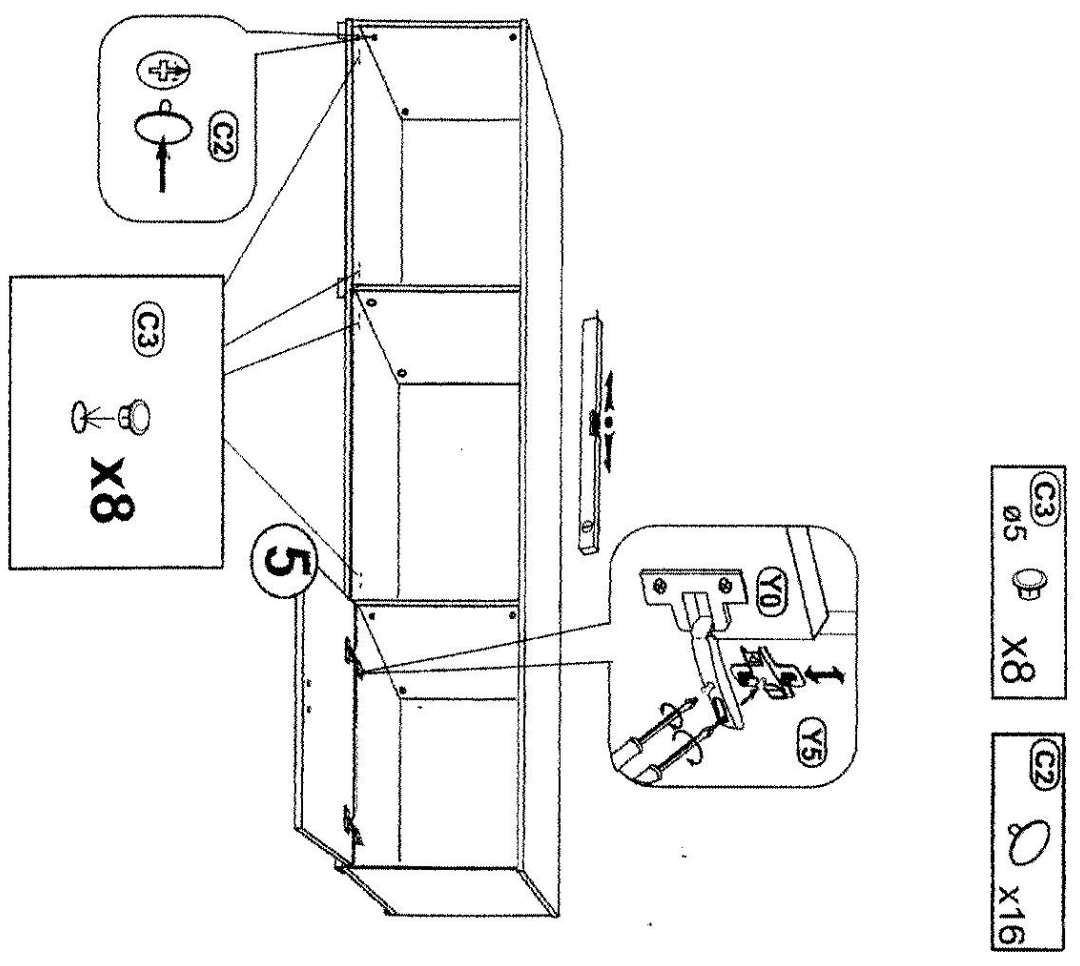

Modelname: **LOGO**

Modellreihe: **29 EM LO**

Type: **80**

Blatt Nr **1** von: **3**

číslo modelu:

strana

Z:

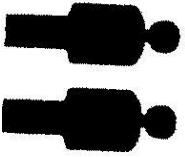

**2 Personen**  
**2 Osoby**

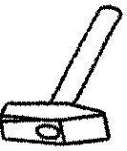
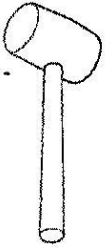
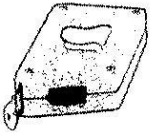

Montážny návod

Nedodržanie postupu pri montáži môže spôsobiť znehodnotenie výrobku.

**Wskazówka dotycząca pielęgnacji!**  
Proszę czyścić tylko suchą lub lekko wilgotną szmatką do kurzu. Nie używać żadnych środków szorstkich!

**MONTAGEANLEITUNG**  
**INSTRUKCJA MONTAŻOWA**

Pozor!

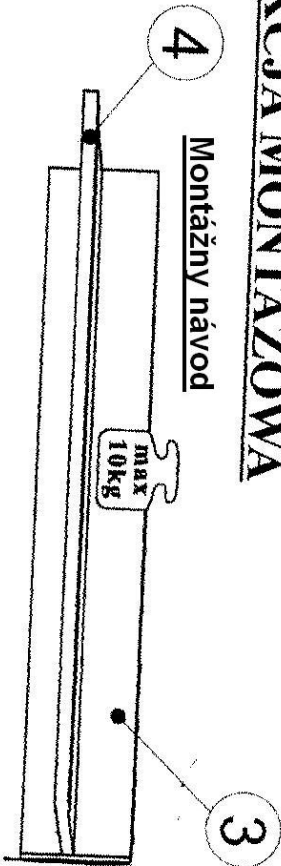
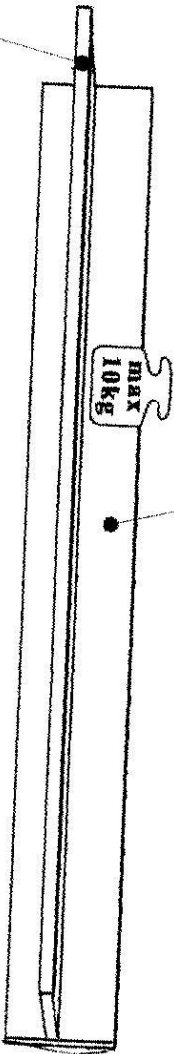

Montážny návod

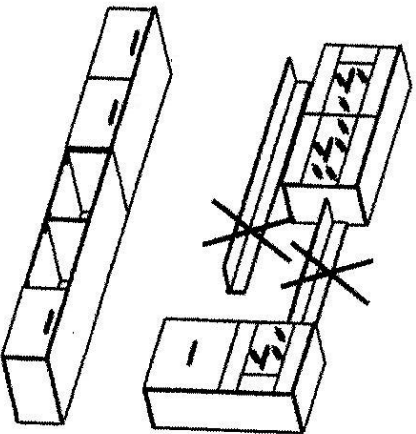

Maximálne prípustné zaťaženie

Von Einlegeböden in kg:

Maksymálne obciążenie pólek w kg:

Stärke/Gr.	Spannplatte/Plyva	Glas/Szklo		
Länge/Dl. mm	15	18	22	5/6
0 < 400				
401 < 600	40	40	40	Länge bis 600 mm/15kg
601 < 800	24			Länge bis 900 mm/10kg
801 < 1000	15	30		

Max. statiský zaťaženie pólky v kg

hrúbka	15	18	22
0-400			
401-600	40	40	40
601-800	24		
801-1000	15	30	

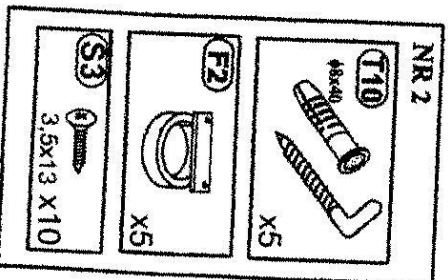
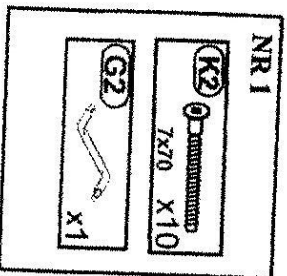

Modelname: **LOGO**  
Názov modelu:

Modellreihe: **29 EM LO**  
číslo modelu:

Type: **80**  
Typ:

Blatt Nr **2** von: **3**  
strana z:

**1**

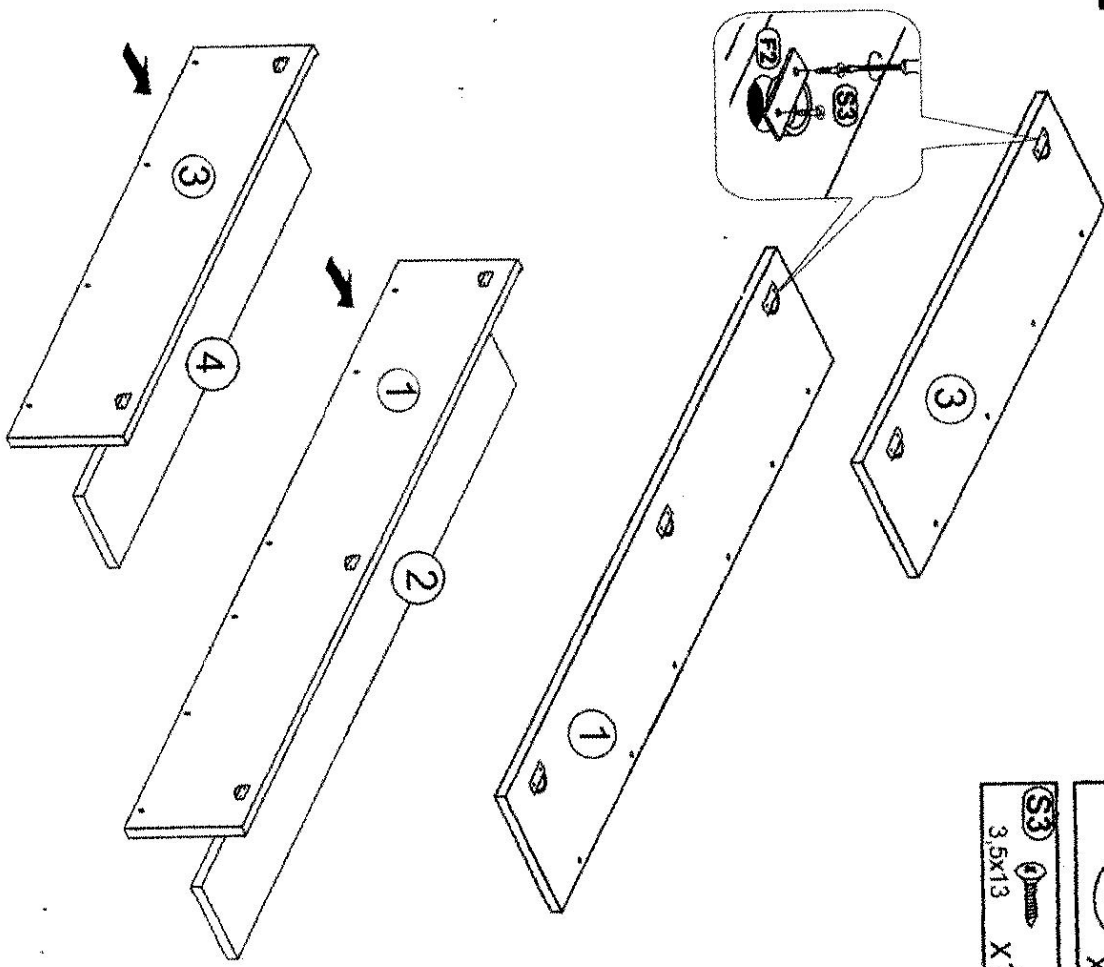

**2**

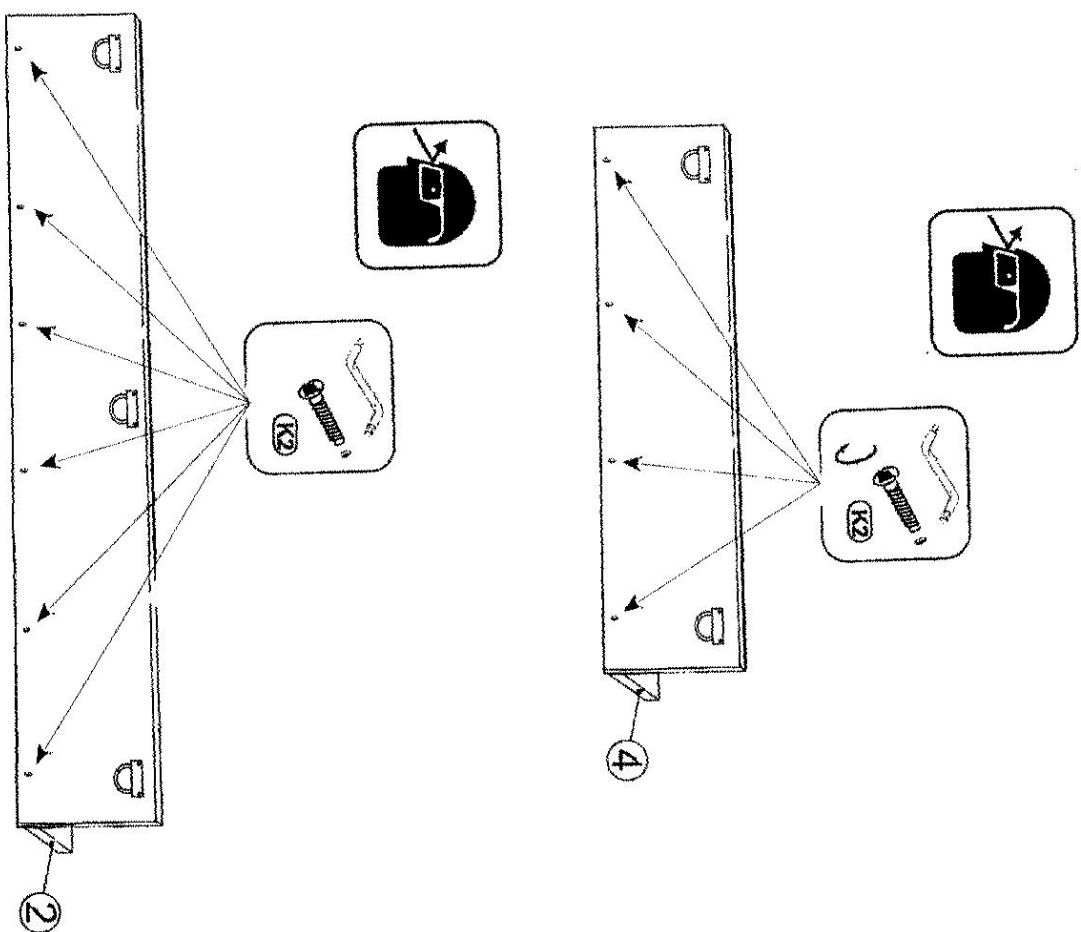



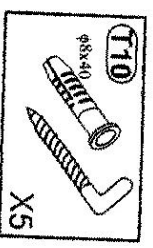
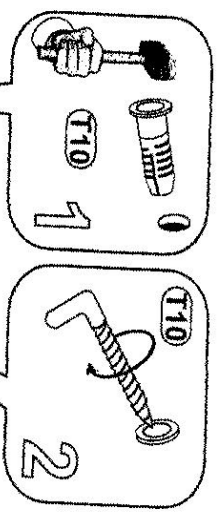
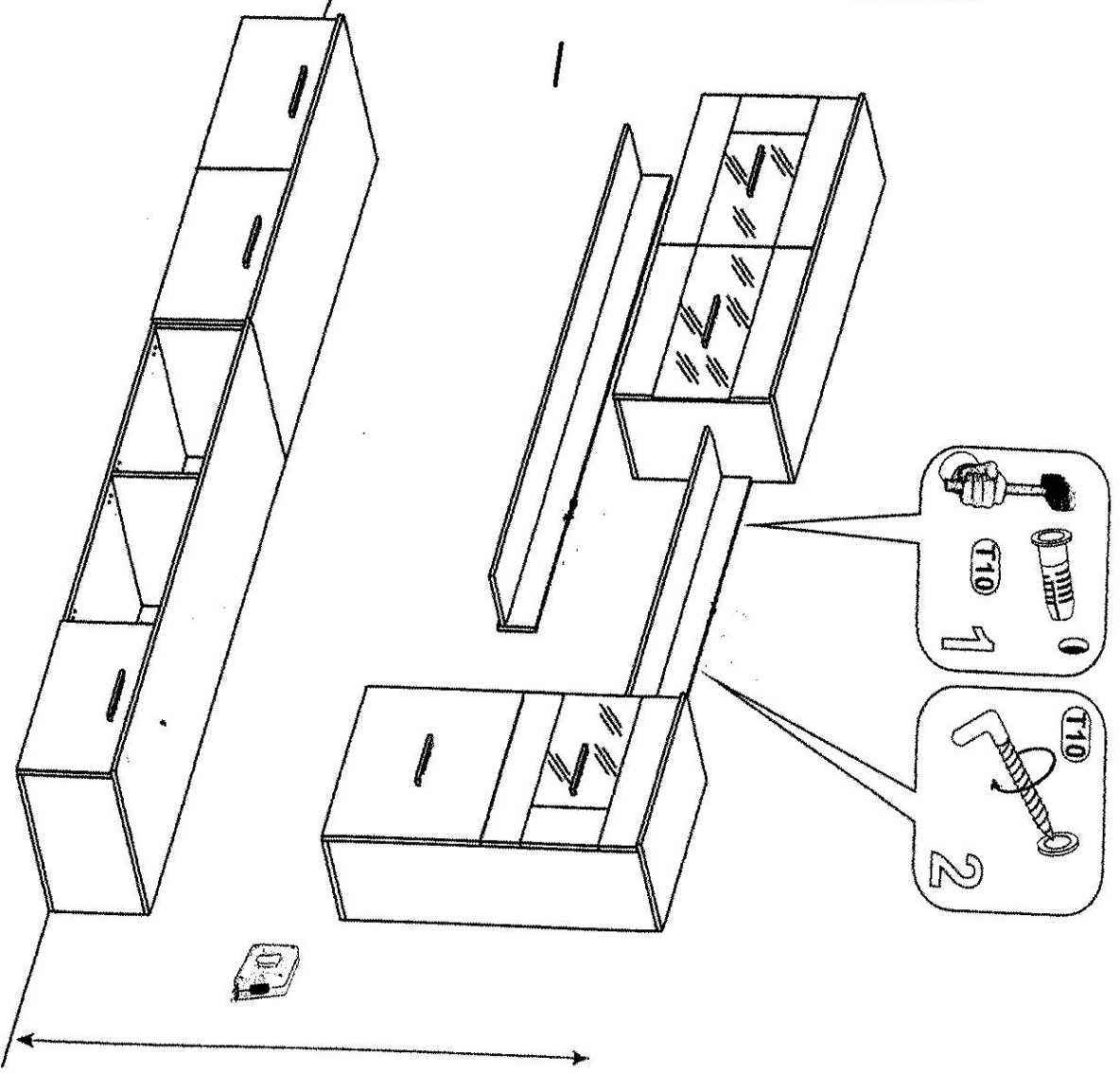

Priložené stránky sú určené do betónových stien, na iný typ stien je potrebné dokúpiť podľa materiálu.

<b>PL</b>	Załączono kółki do zawieszania bryły, do stosowania wyłącznie do ścian betonowych, do innych ścian należy odpowiednio dokupić.
<b>GB</b>	Attached dowels to hang up unit are for concrete walls only. For other types of walls, appropriate dowels must be purchased
<b>D</b>	Die beigefügten Dübel zum Aufhängen des Elements dürfen nur bei Betonwänden eingesetzt werden, bei anderen Wandarten müssen entsprechende Dübel zugekauft werden.
<b>F</b>	Les chevilles jointes, pour pendre l'élément, sont pour les murs bétonnés exclusivement; pour autres murs il faut acheter chevilles adéquates



100cm

50cm

30cm

100cm

150cm

150cm

100cm

115cm

100cm

100cm

50cm

37cm

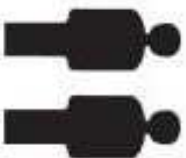

**2 Personen**  
**2 Osoby**



**PRED ZAČIATKOM  
MONTÁŽE, SI POZORNE  
PREŠTUDUJTE  
MONTÁŽNY NÁVOD.**

**UPOZORNENIE!**

Prostriedky skvorny udrerac' len prachovkou alebo vlhkou handričkou. Nepoužívajte agresívne čistiacie prostriedky!

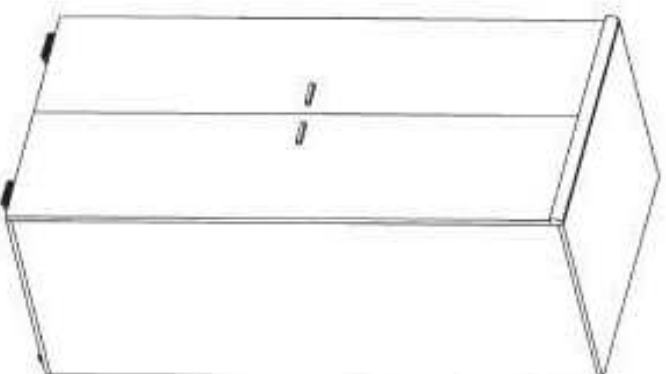

# Montážny návod

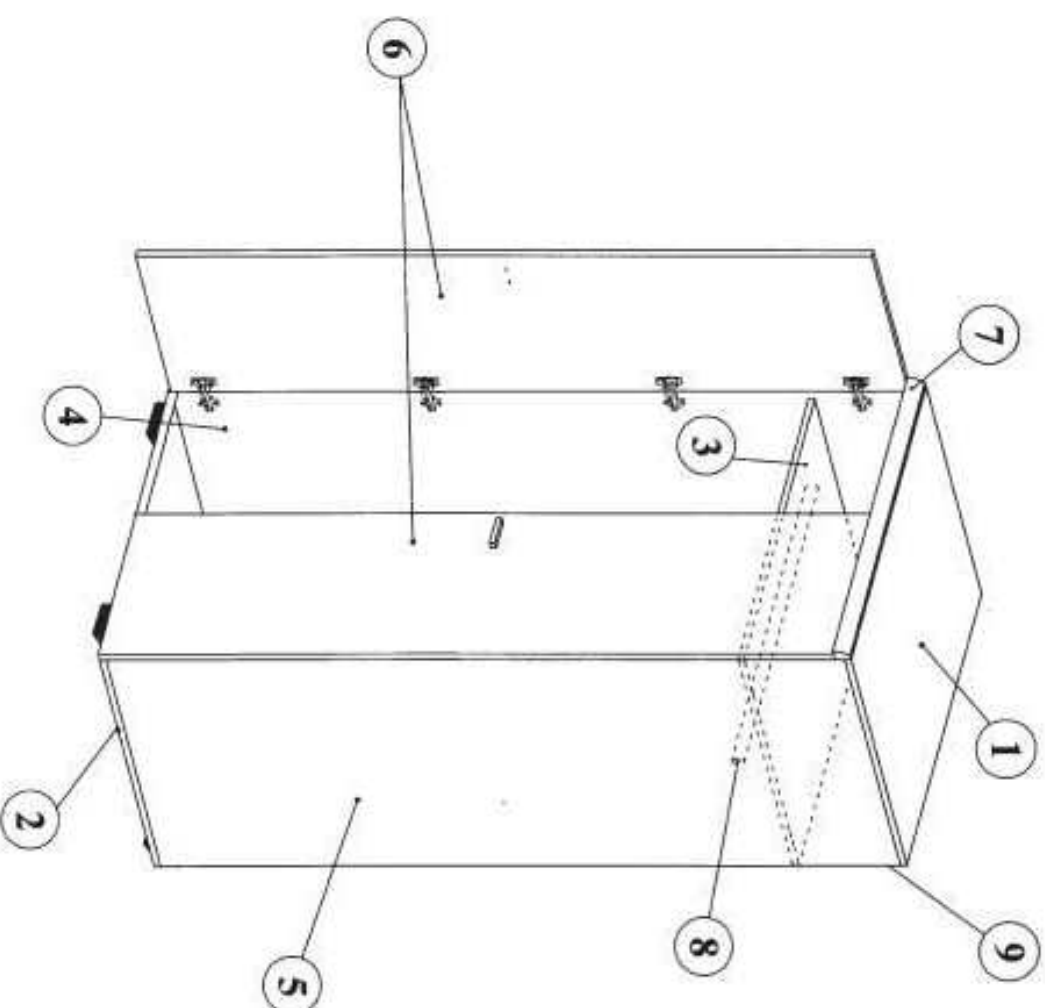

Max. prípustné zaťaženie poličiek v kg:

Dĺžka	Hrúbka		Polička		
	mm		15	18	22
0<400					
401<600			40	40	40
601<800			24		
801<1000			15	30	

Modelname: **LOGO**  
Nazwa modelu:

Modelreihe: **29 EM LU** Type: **93**  
Numer modelu: Typ:

strana

2 von: 7  
Z:

MODEL

ČÍSLO MODELU

# Montážny návod

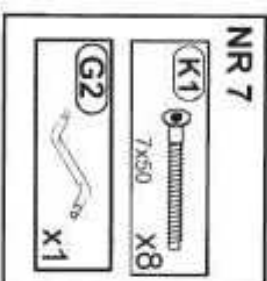
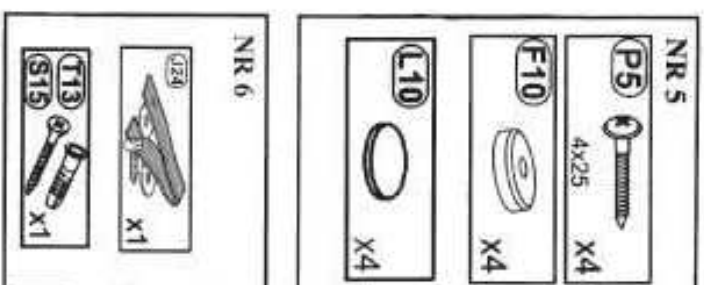
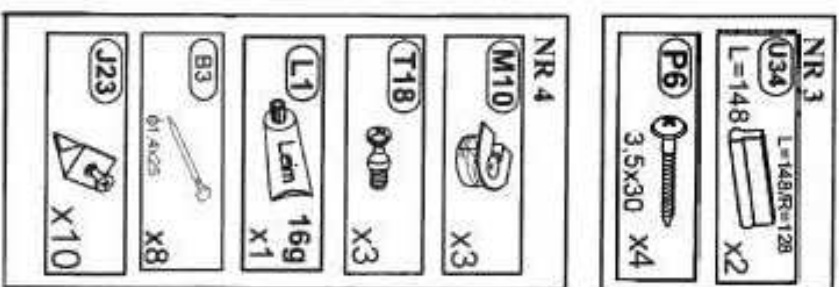
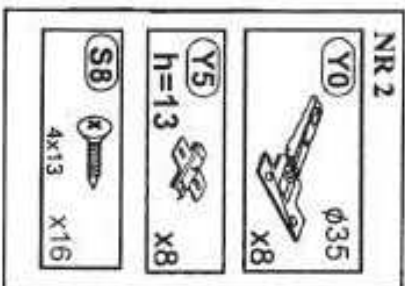
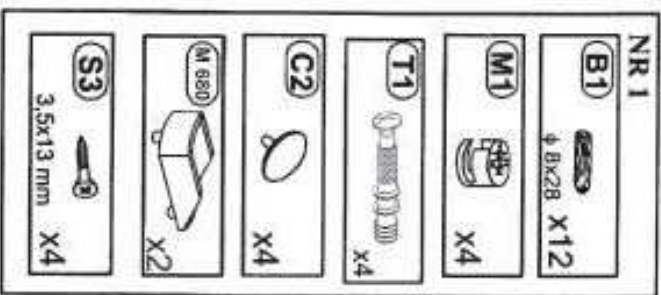



Modelname: **LOGO**  
 Nazwa modelu:

Modelreihe: **29 EMLU** Type: **93**  
 Numer modelu: Typ:

strana: **3** von: **7**  
 z:

**1**

 M 580 x2	 V x1	 P5 4x25 x4	 B1 1,8x28 x12
 S3 3,5x13 mm x4	 Y5 x8	 F10 x4	 M1 x4
		 L1 16g x1	 T1 x4
			 M10 x3

Pozor excentra vbiťat  
 pomocou drevene  
 doštičky

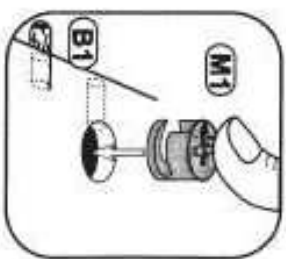
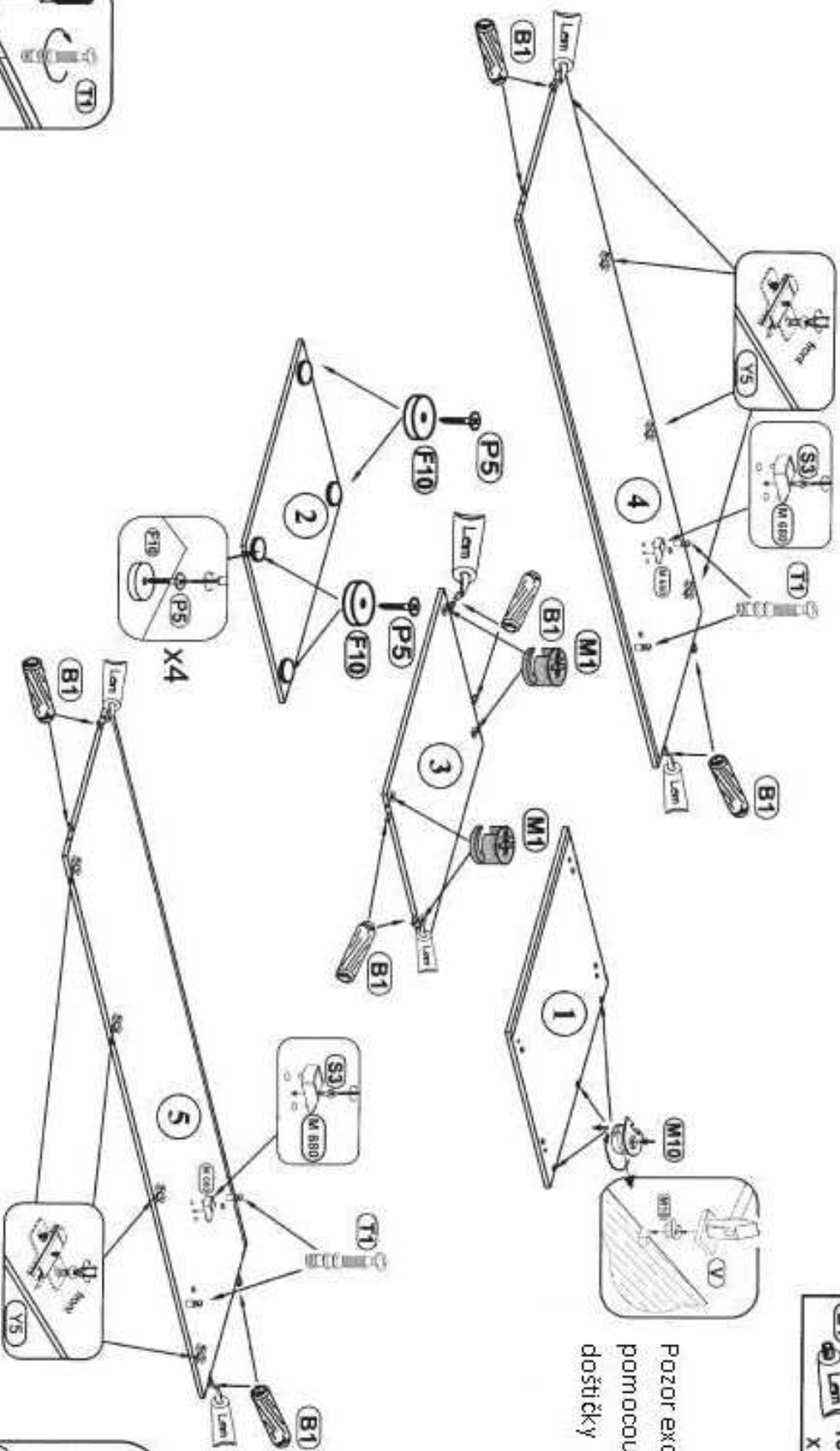

Modelname: **LOGO**  
 Nazwa modelu:

Modelreihe: **29 EM L U** Type: **93**  
 Numer modelu: Typ:

strana: **4** von: **7**  
 z:

**2**

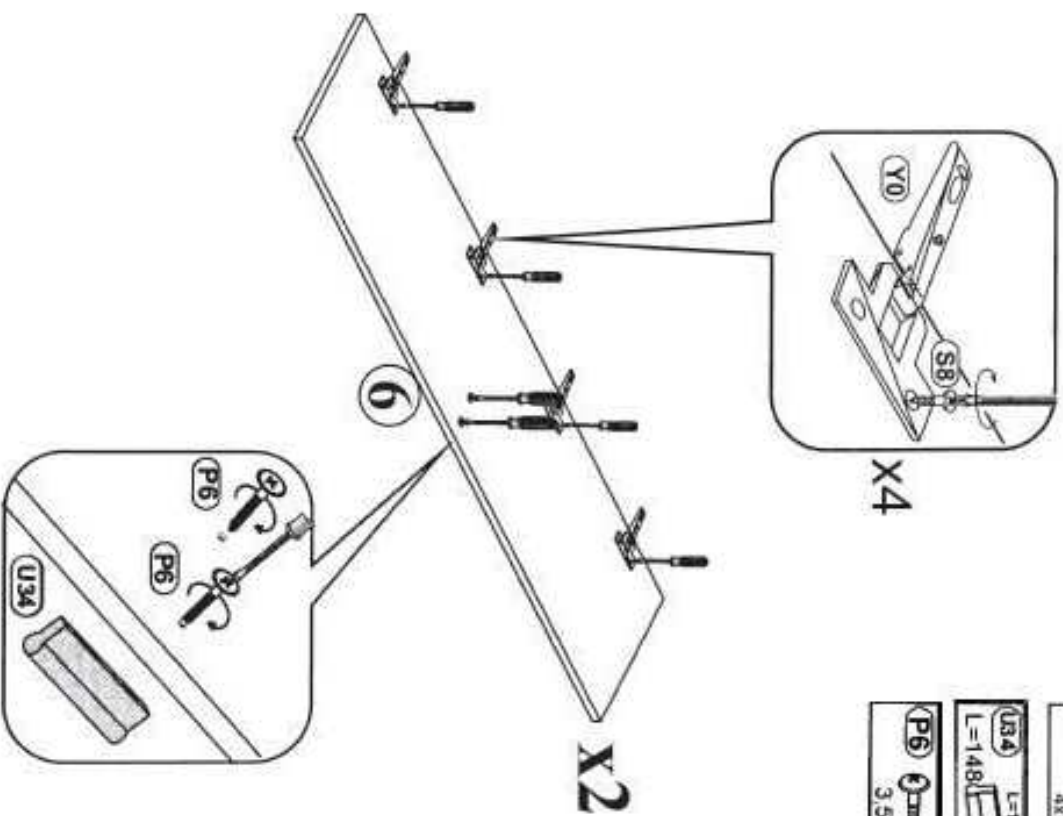

- Y0** \*35 X8
- S8** 4x13 X16
- U34** L=148, R=128 X2
- P6** 3,5x30 X4

**3**

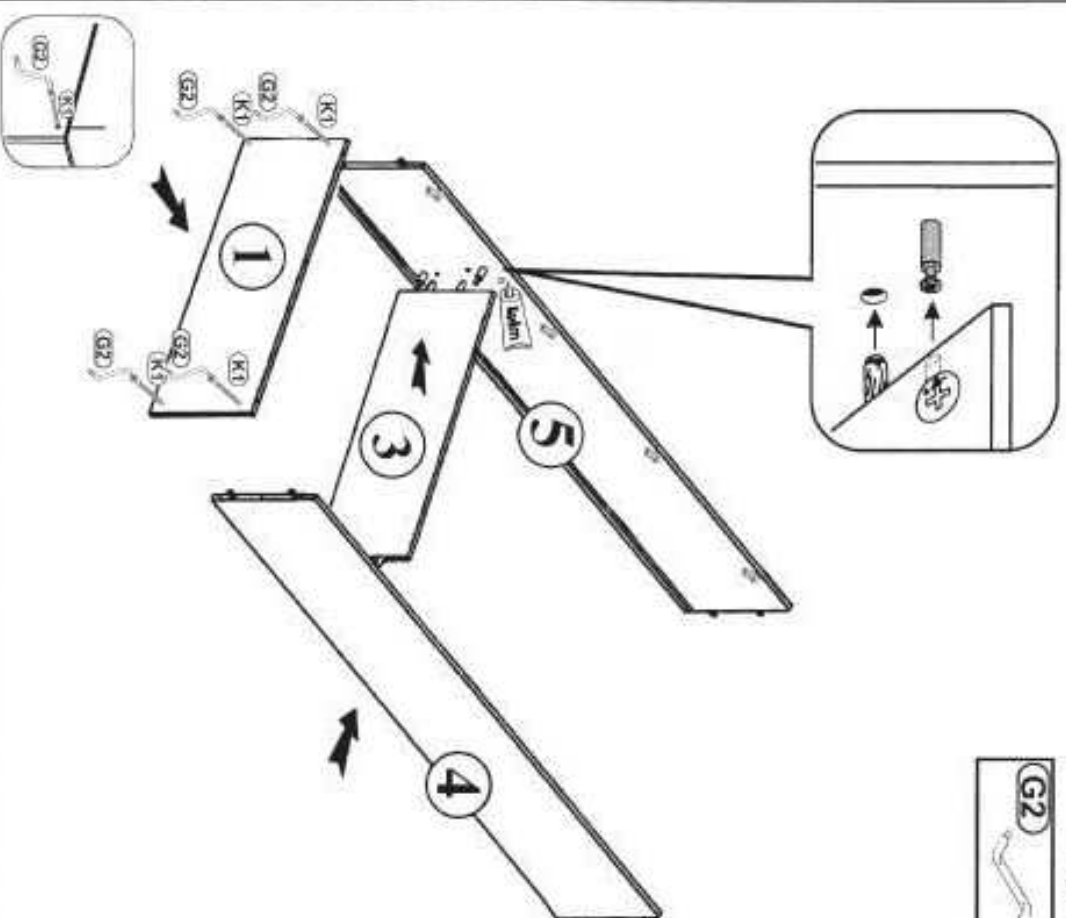

- L1** \*1 X1
- K1** 7x50 X4
- G2** X1



Modelname: **LOGO**  
 Nazwa modelu:

Modelreihe: **29 EMLU**  
 Numer modelu:

strana **5** von **7**  
 z:

**4**

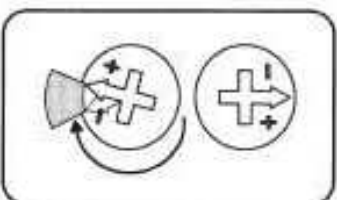
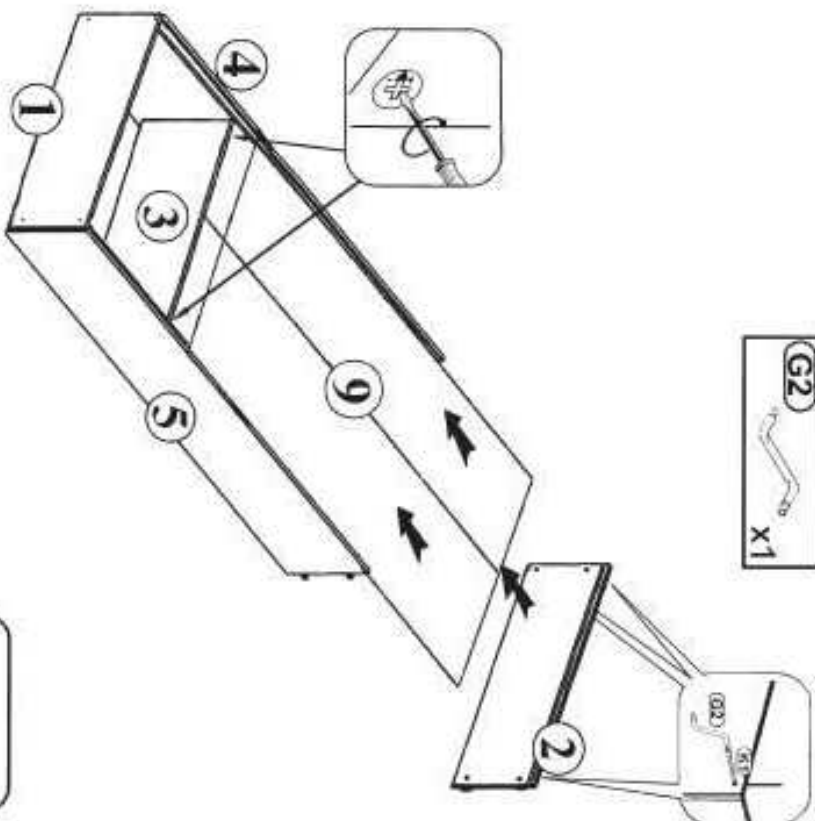
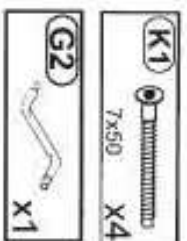

**5**

