

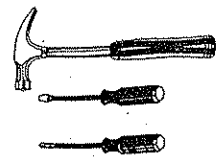









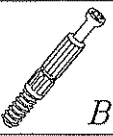

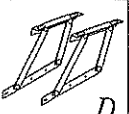
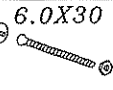
MARIO M-12

DIG-NET®
Jan Lenart
meble



 A	 B	 C	 D	 6.0X30 E	 F	 4.5X20 G
28	28	28	1 KPL	6	38	8
<p>Szanowny kliencie, gdyby brakowało jakiegos części, lub byłaby uszkodzona proszę to oznaczyć na instrukcji montażowej i przestać razem z reklamacją. UWAGA! Jeżeli uszkodzony element będzie zamontowany na stałe reklamacja nie będzie uznana. Proszę czyścić tylko suchą lub lekko wilgotną szmatką do kurzu. Nie używać żadnych środków szorstkich!</p>				 L	 H	 I
				1 KPL	2	1
				 K	 J	
				3.5X13	3.5X40	
				10	4	

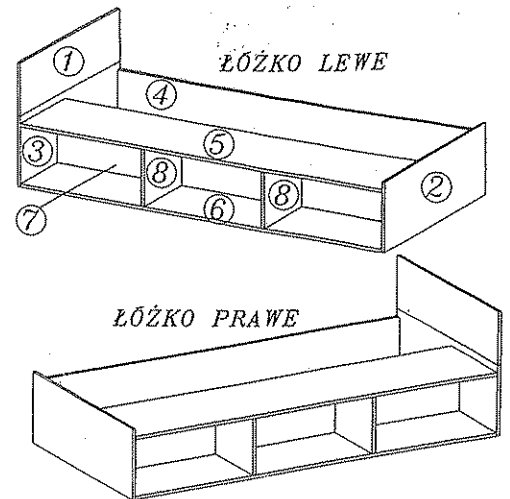

1

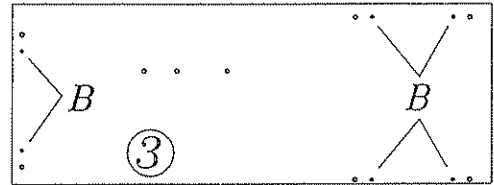
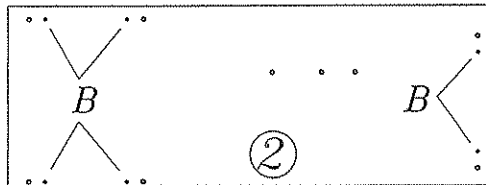

2

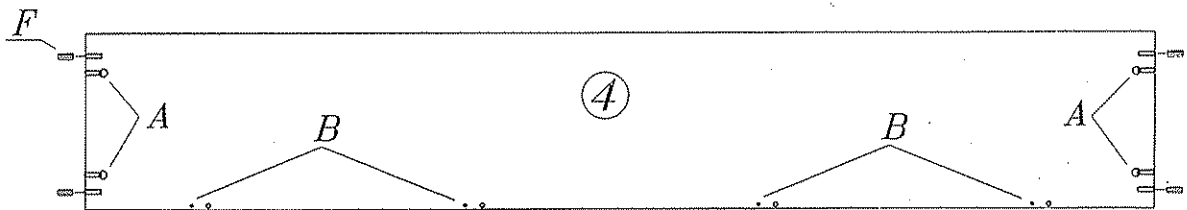

3

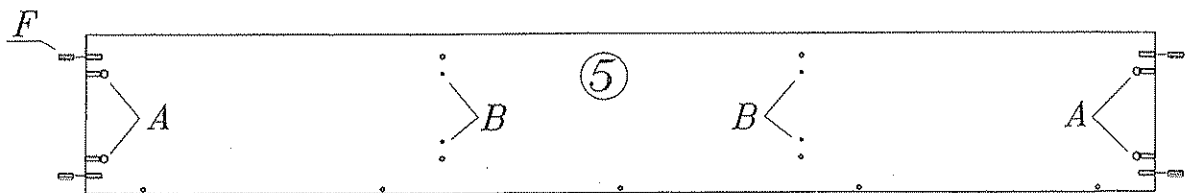

4

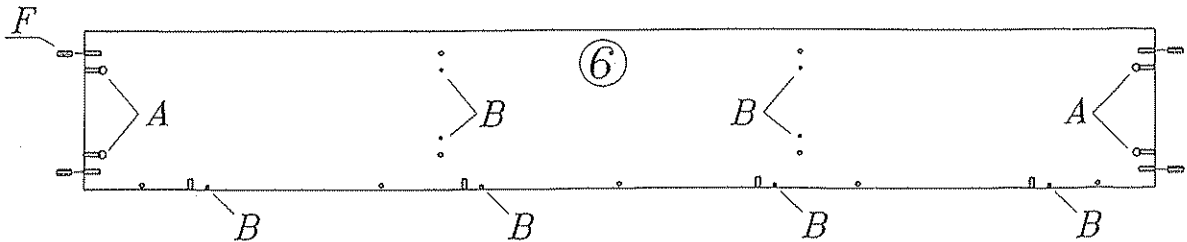

5

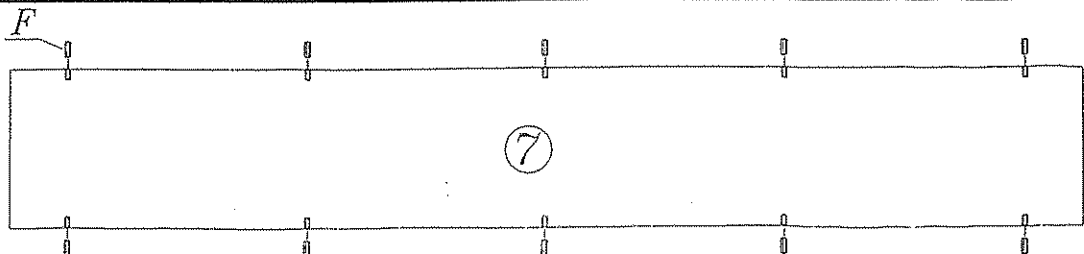

6

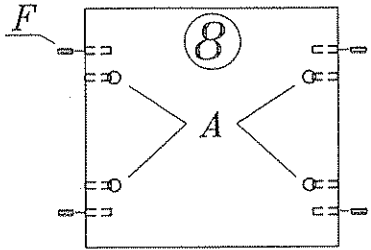

6

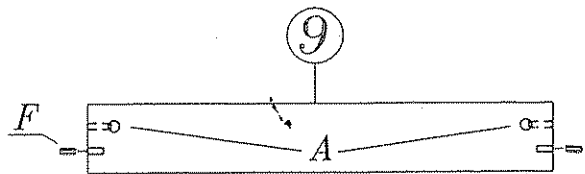

7

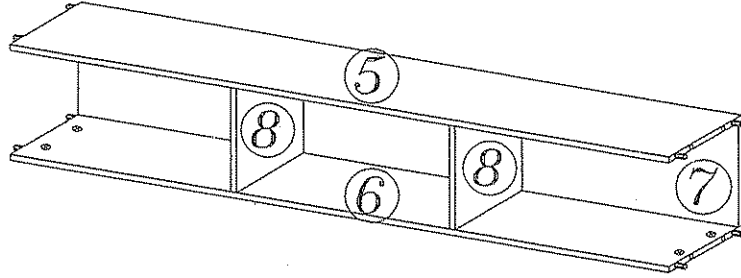
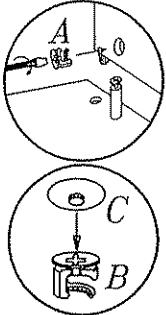

8

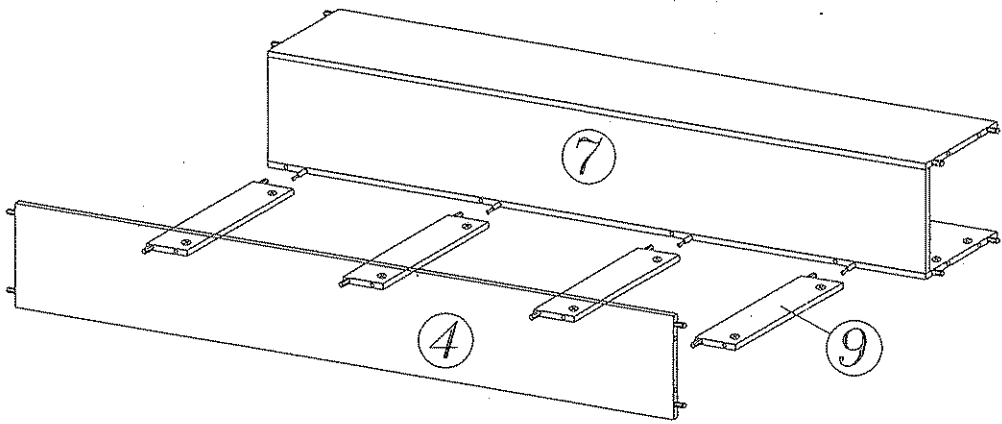
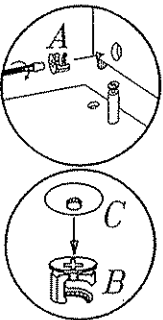

9

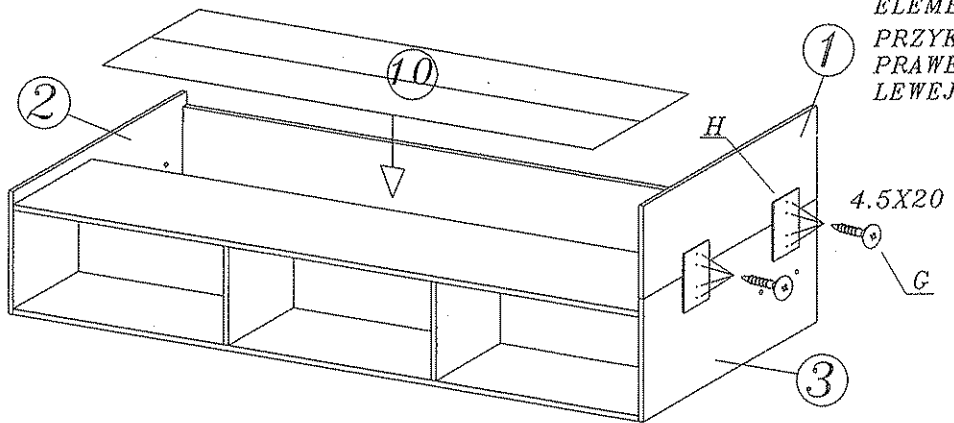
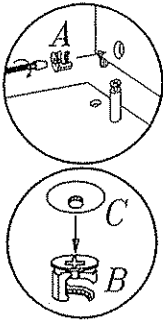

ELEMENT 1 MOŻNA
PRZYKRĘCIĆ Z
PRAWEJ, LUB Z
LEWEJ STRONY

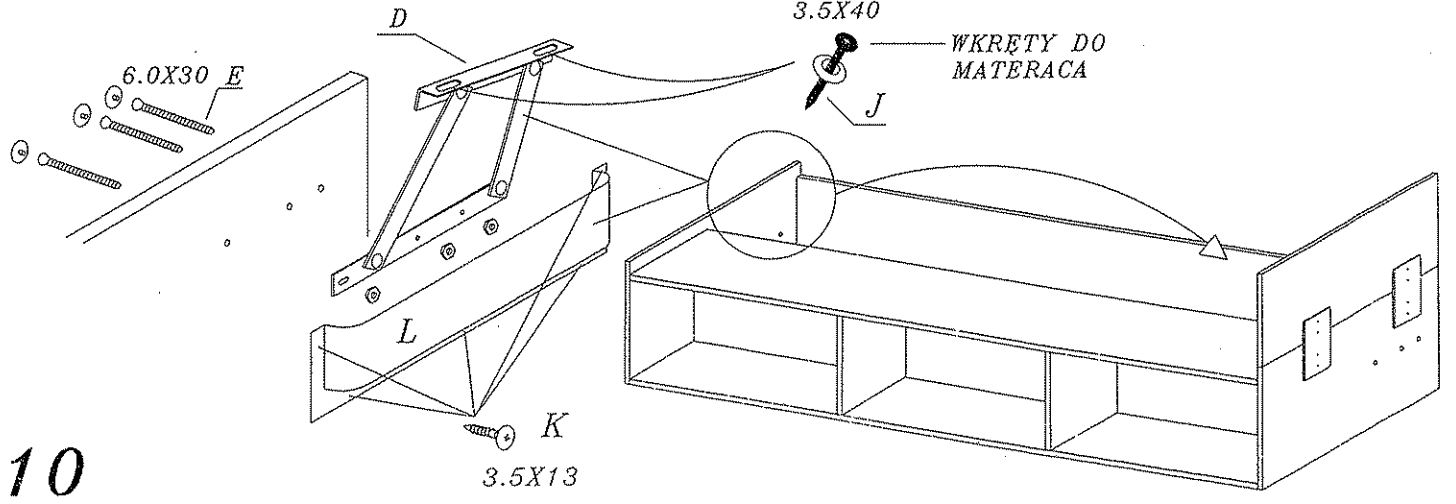

10

WKRETY DO
MATERACA