

		S1		S11	
A	B	C (mm)		D	
1	S229-309	472	384	2/3	
2	S229-310	472	384	2/3	
3	S229-312	471	354	2/3	
4	S229-318	472	364	2/3	
5	S229-405	1917	472	2/3	
6	S229-552	282	356	2/3	
7	S229-553	282	469	2/3	
8	S229-709	767	499	3/3	
9	S229-710	957	499	3/3	
10	S229-711	769	400	1/3	
11	S229-712	769	400	1/3	
12	S229-713	959	400	1/3	
13	S229-714	959	400	1/3	
14	qc11/1			1/3	

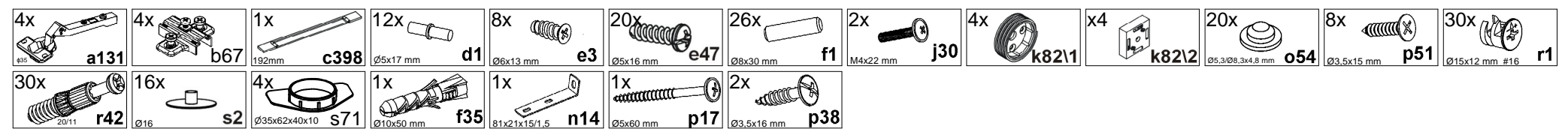

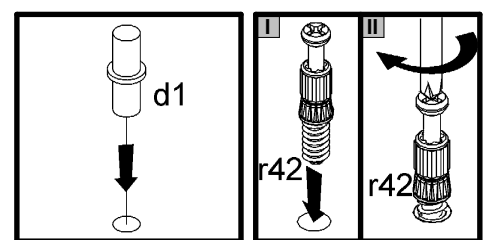

1 §2

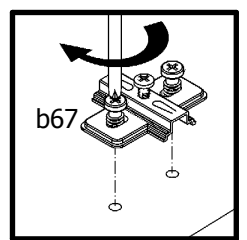
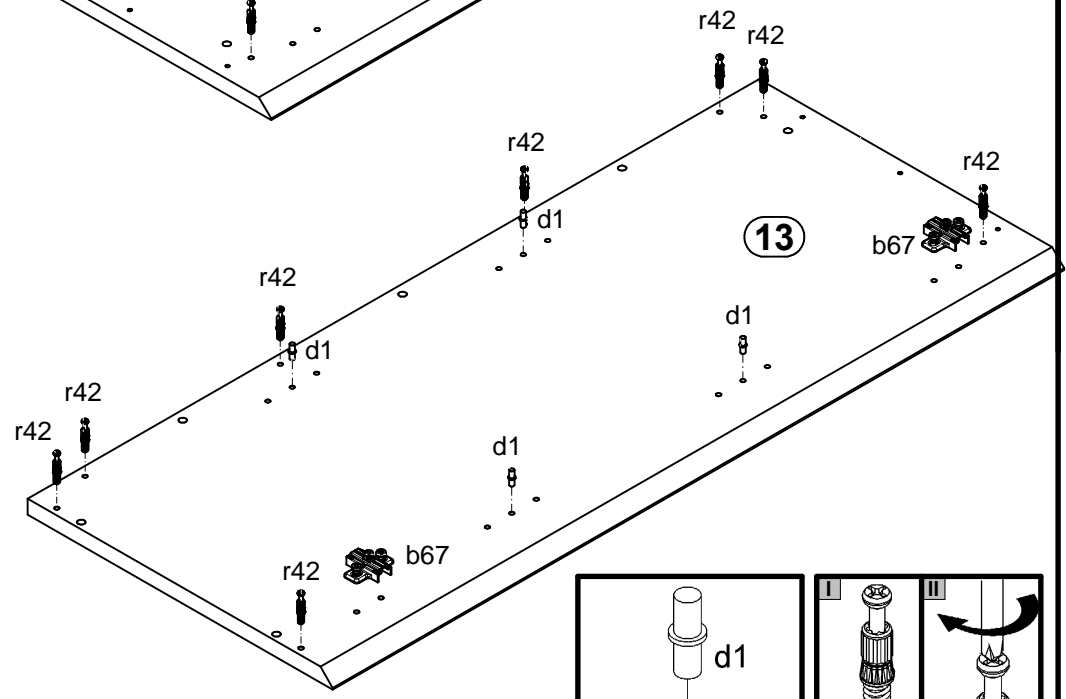
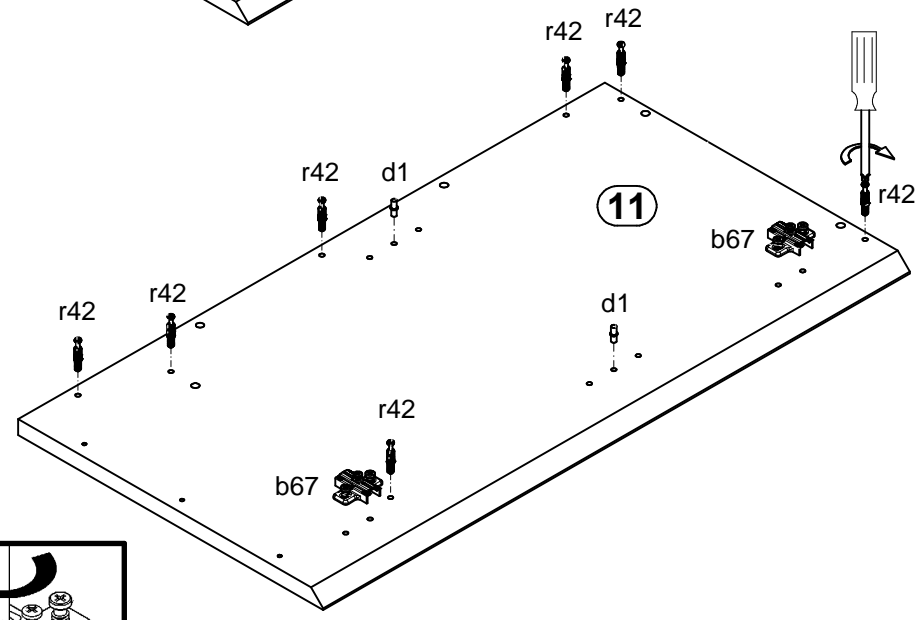
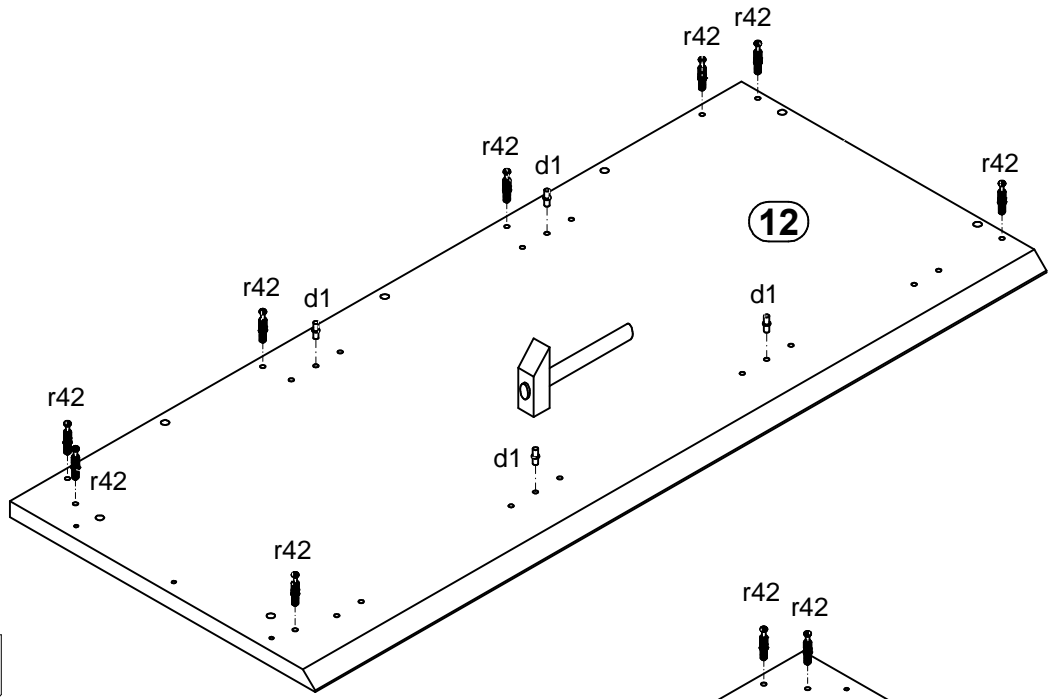
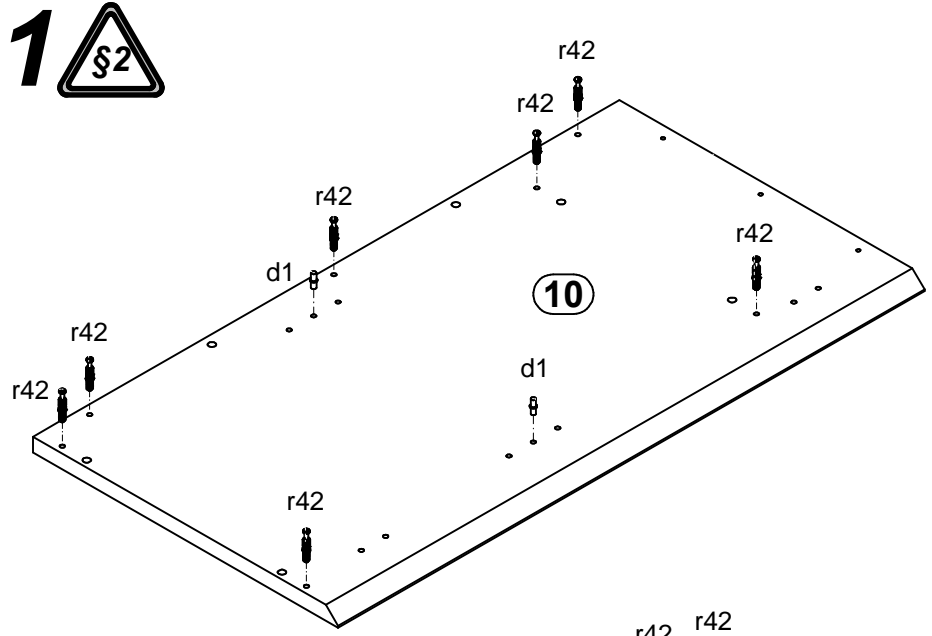
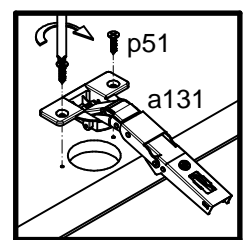
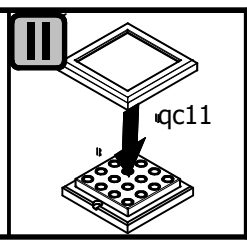
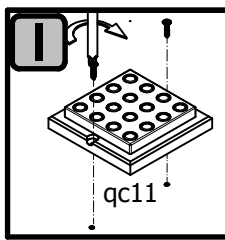
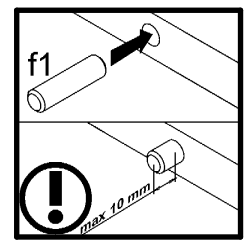
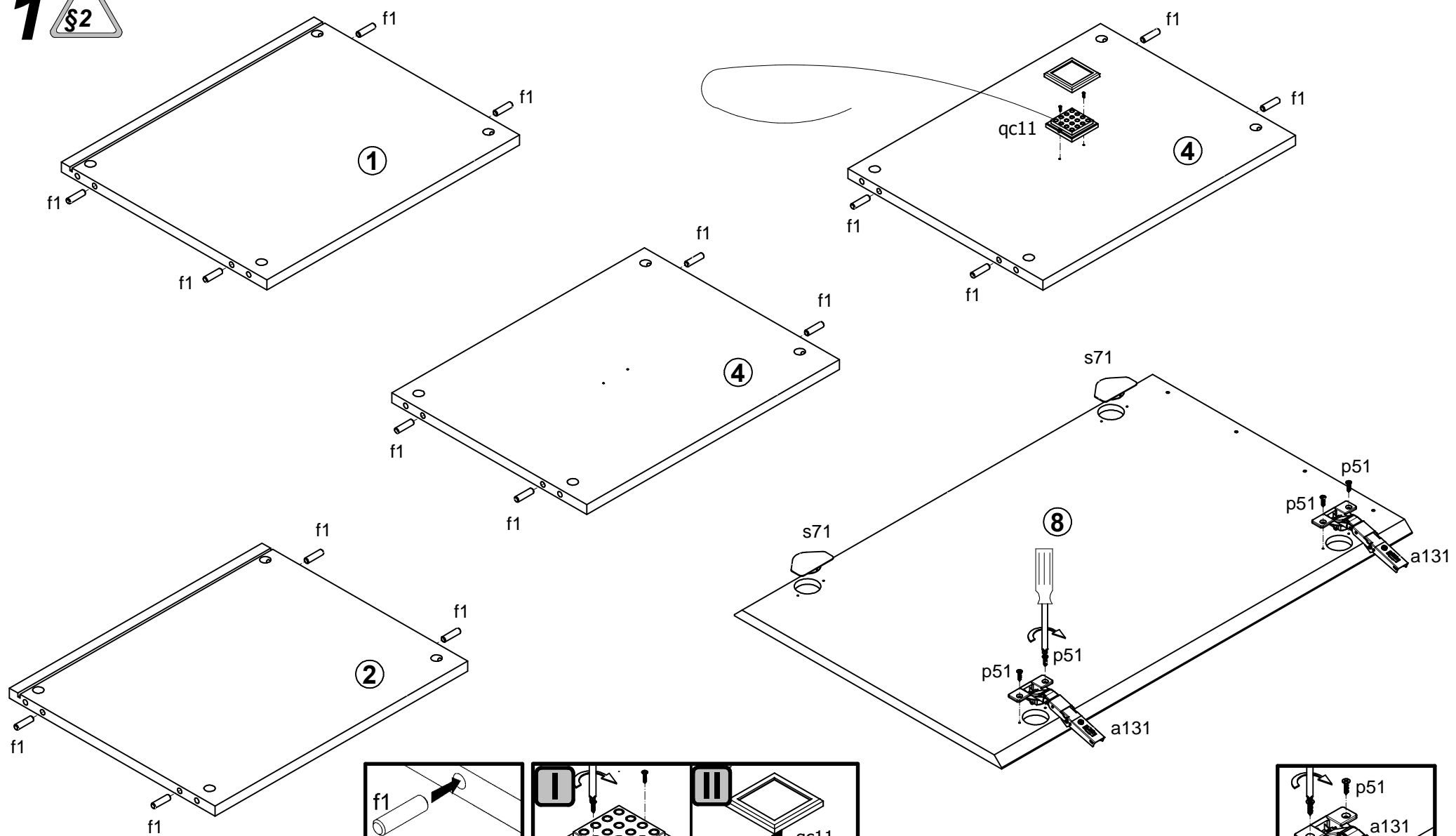

1 §2

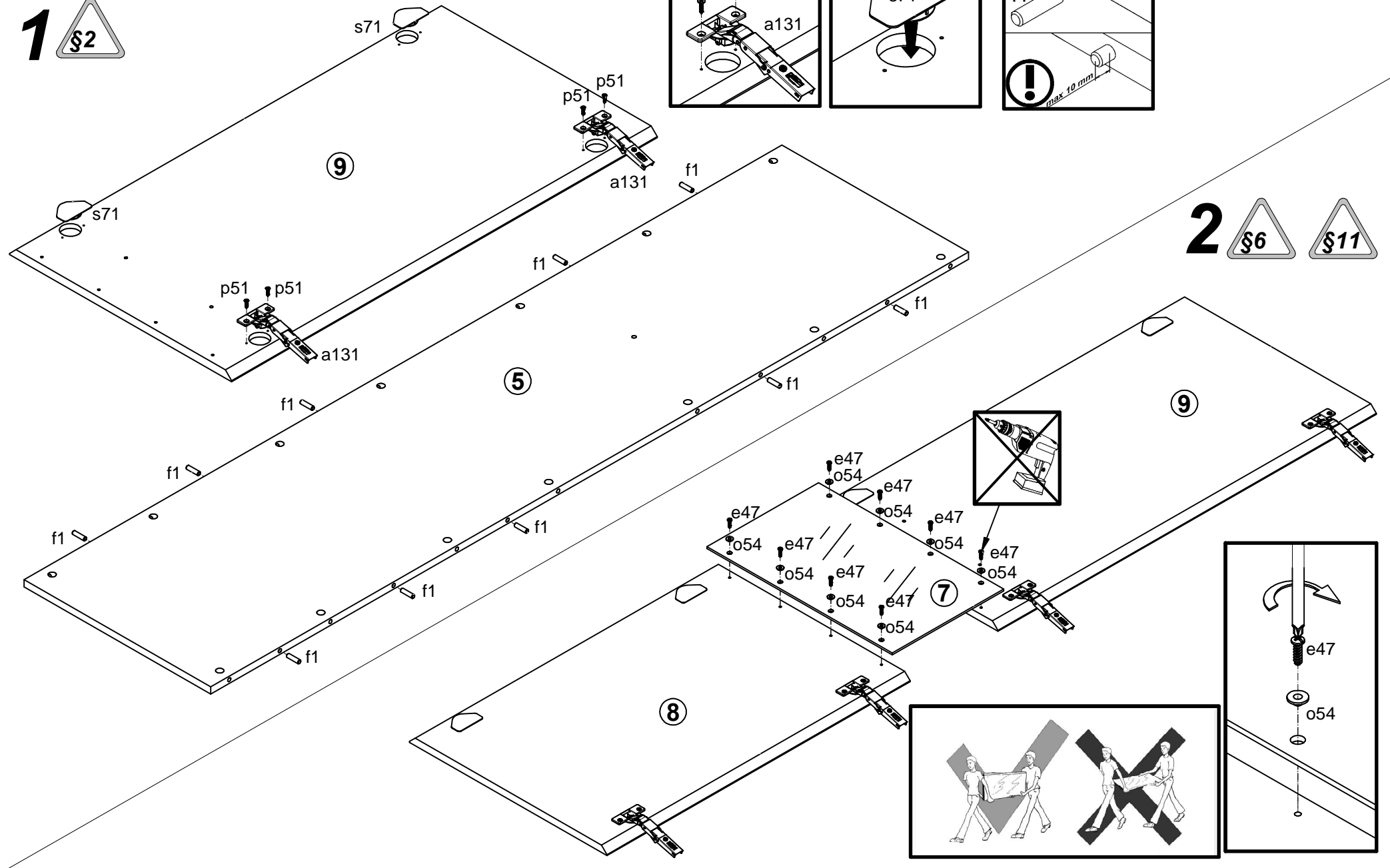
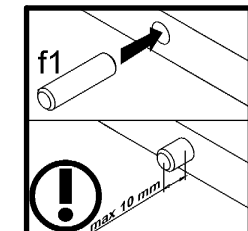
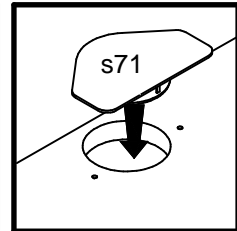
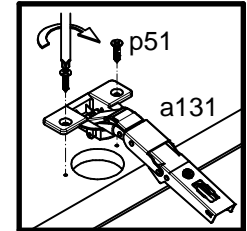

2 §6 §11

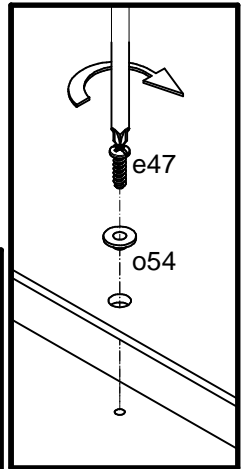
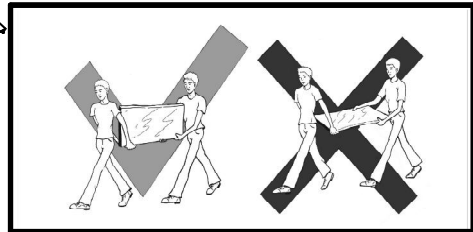
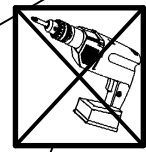

3 §6 §11

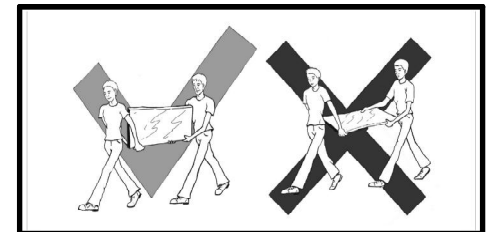
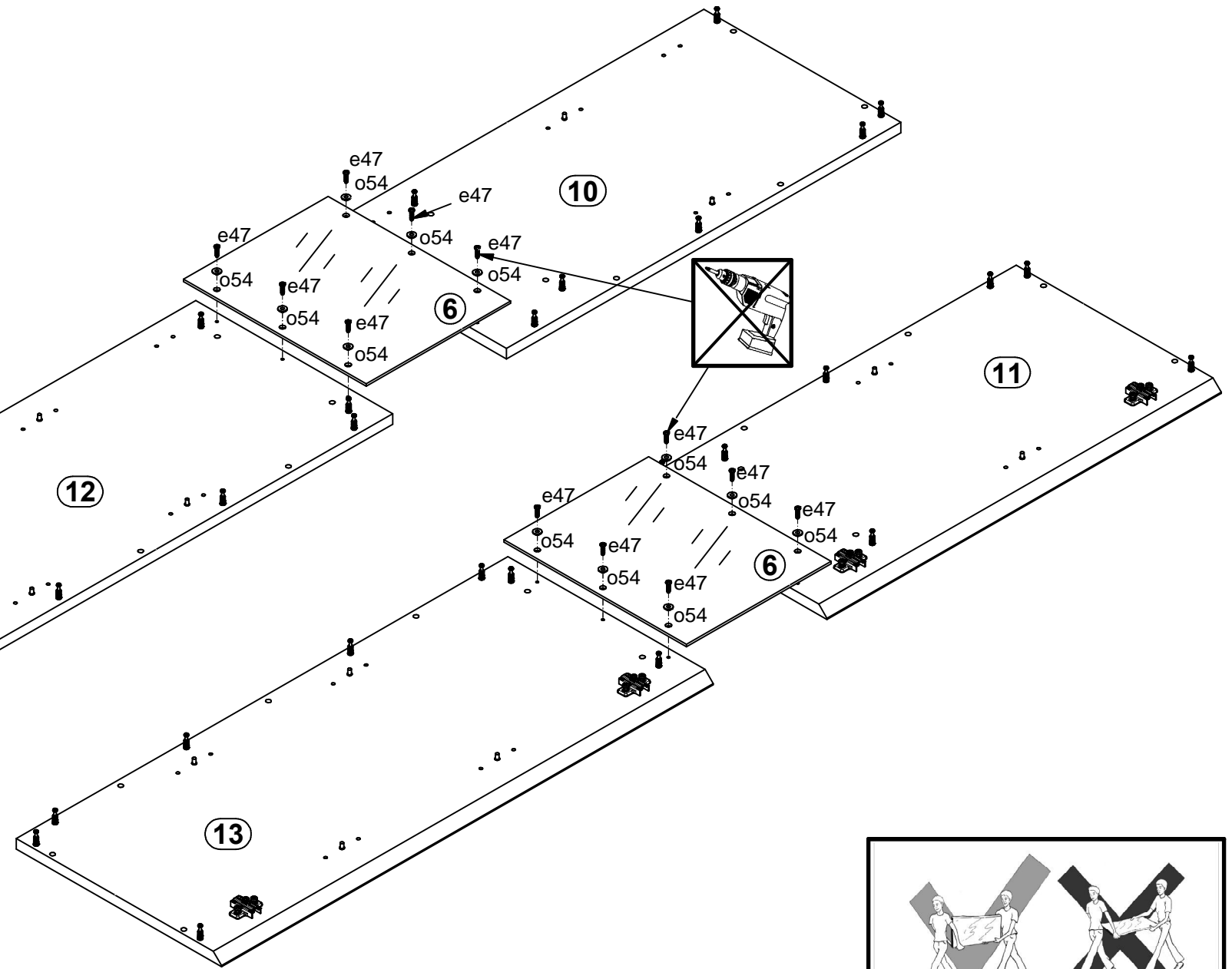
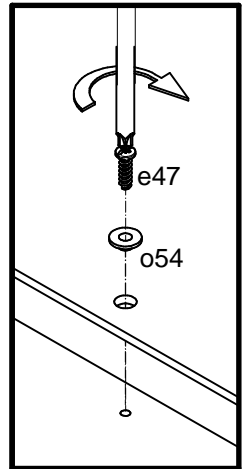

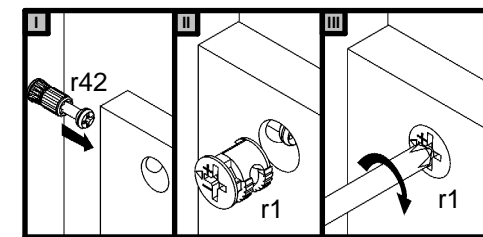
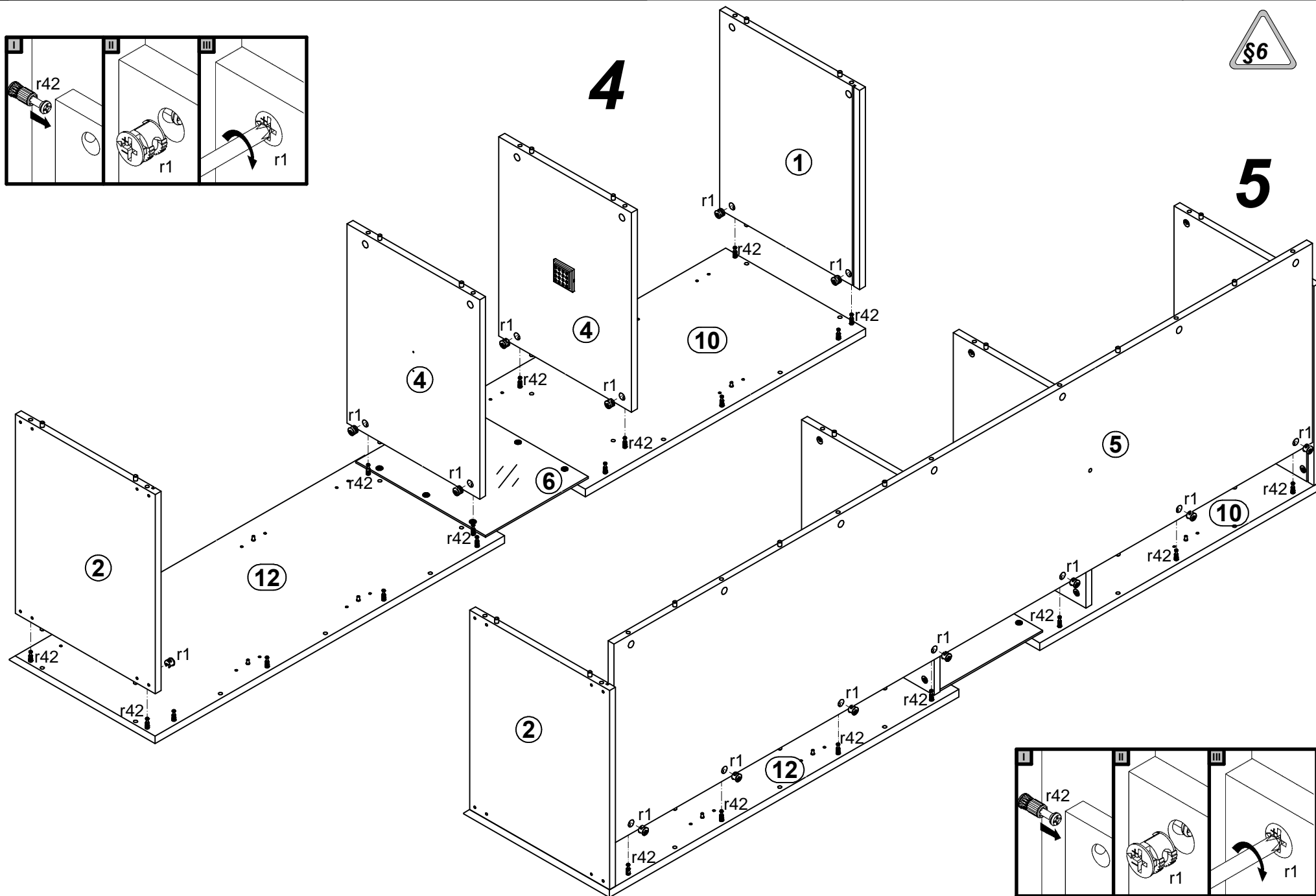
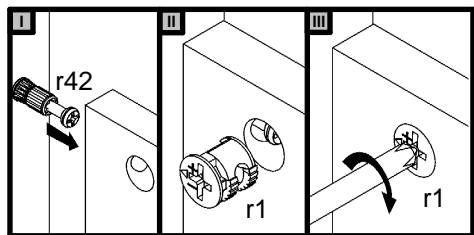

6

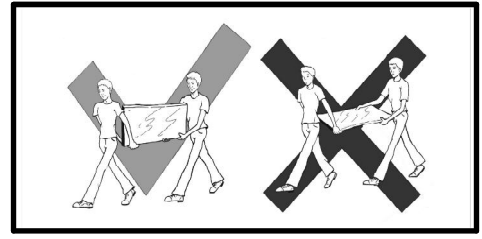
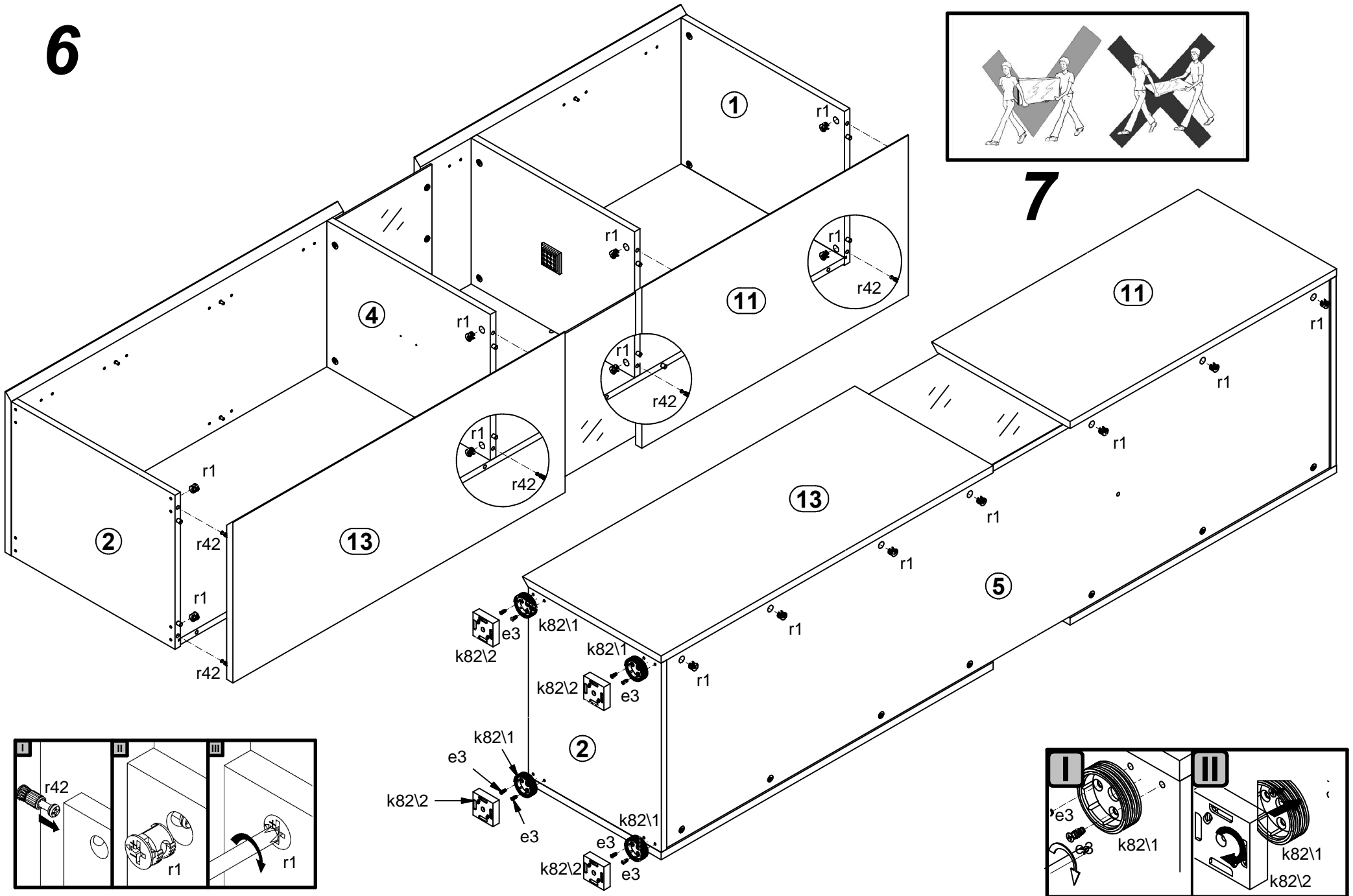

7

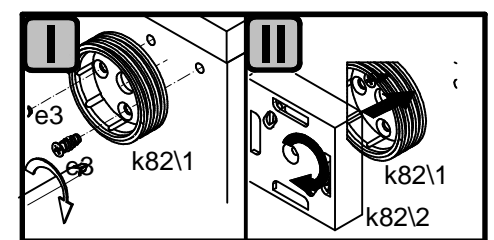
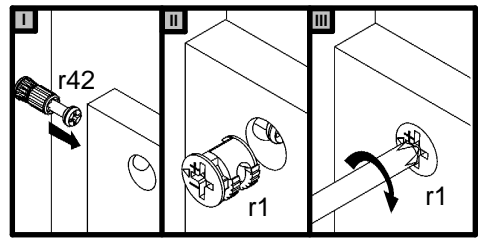

8 §6 §11

