

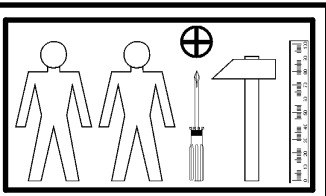

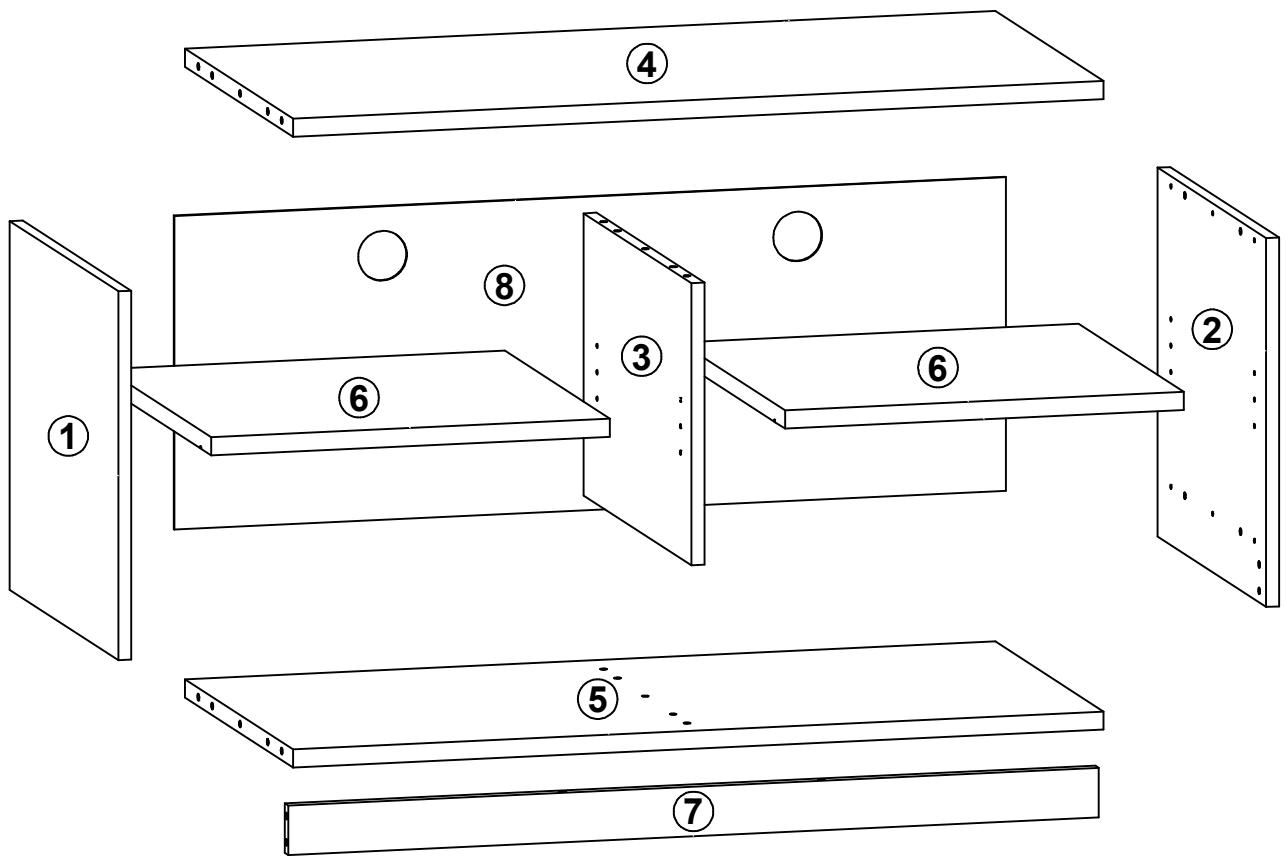

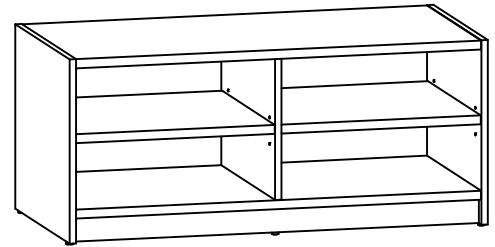





# LENDI

## S95-RTV/103

A	B	C	D	
1	S95-115	447	500	1/2
2	S95-116	447	500	1/2
3	S95-117	342	496	1/2
4	S95-310	1000	498	2/2
5	S95-311	1000	498	1/2
6	S95-312	492	484	1/2
7	S95-405	1000	60	1/2
8	S95-907	380	1026	1/2



8x  φ5x17 mm d1	3x  φ7x50 mm e1	18x  φ8x30 mm f1	5x  k1	33x  l1	15x  φ1.5x12mm #16 r1	15x  r42	1x  z1	3x  ø16 s2
---	---	--	---	--	---	---	---	--

# 1

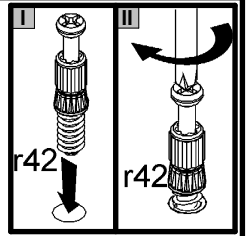
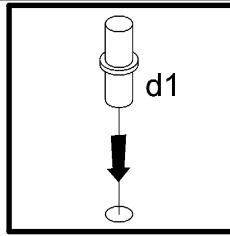
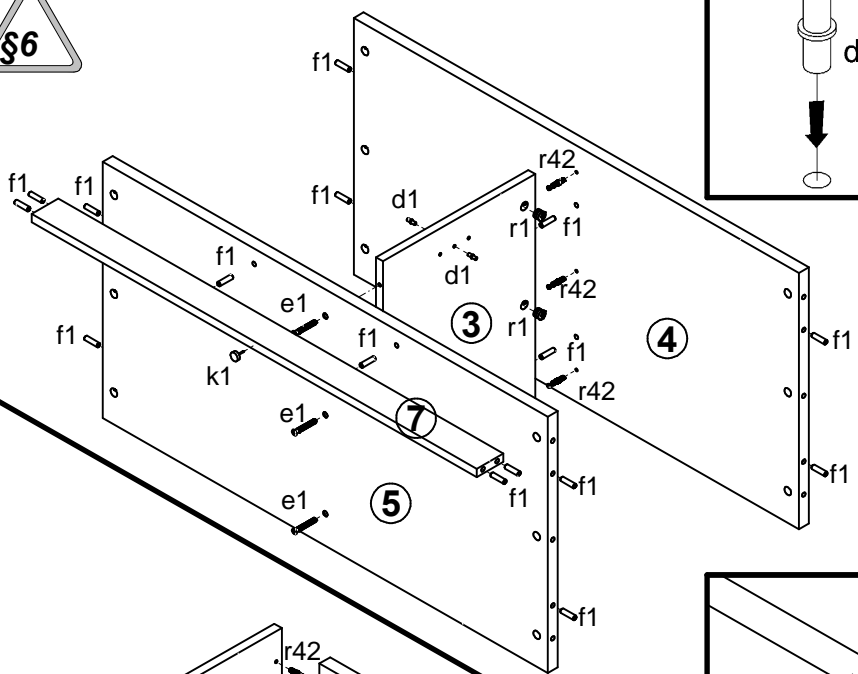

# 2

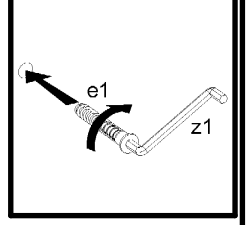
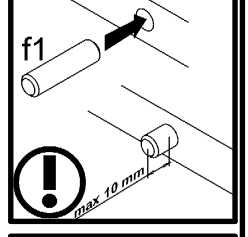
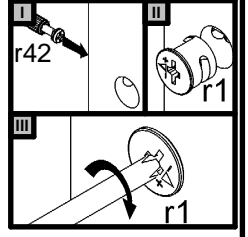
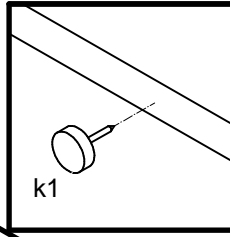
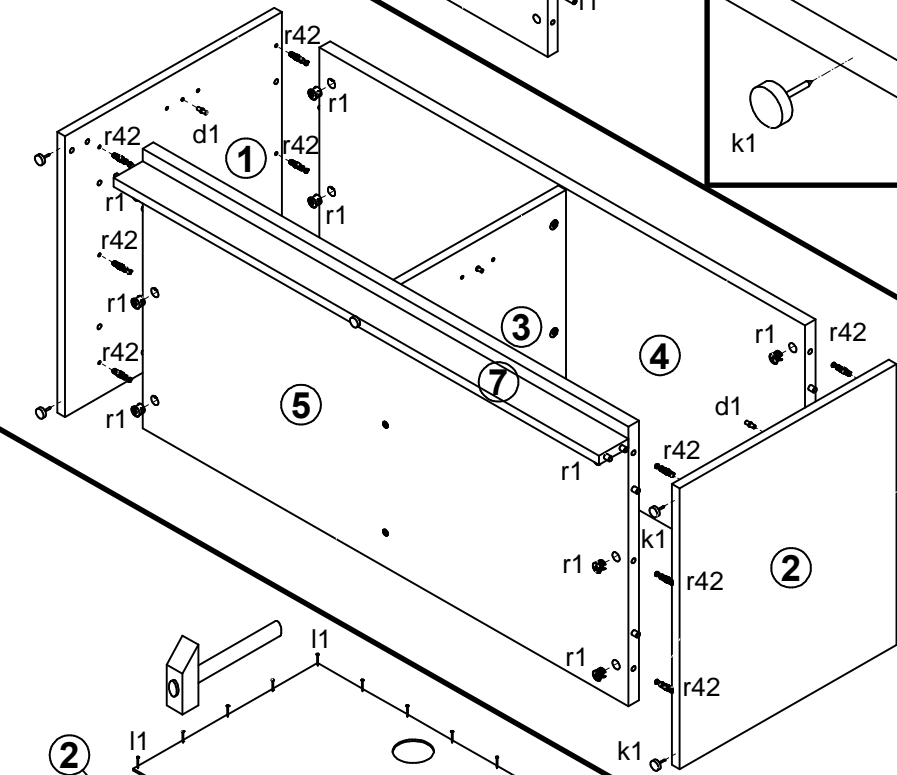
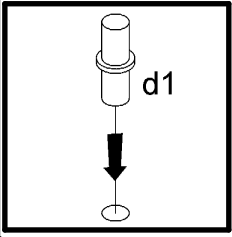
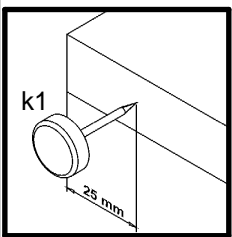

# 3

