

A	B	C	D	
1	S136-148	398	243	1/2
2	S136-149	398	243	1/2
3	S136-150	352	223	1/2
4	S136-213	1030	243	1/2
5	S136-324	490	222	1/2
6	S136-325	997	243	1/2
7	S136-573	1031	65	2/2
8	S136-591	416	65	2/2
9	S136-596	1031	65	2/2
10	S136-922	362	1007	1/2

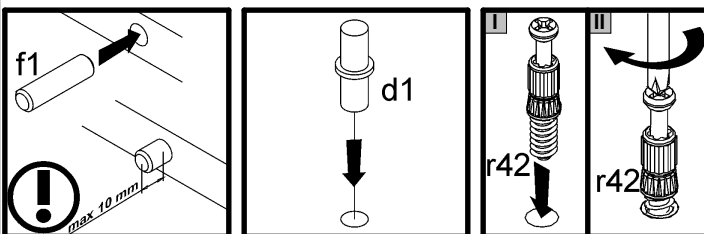

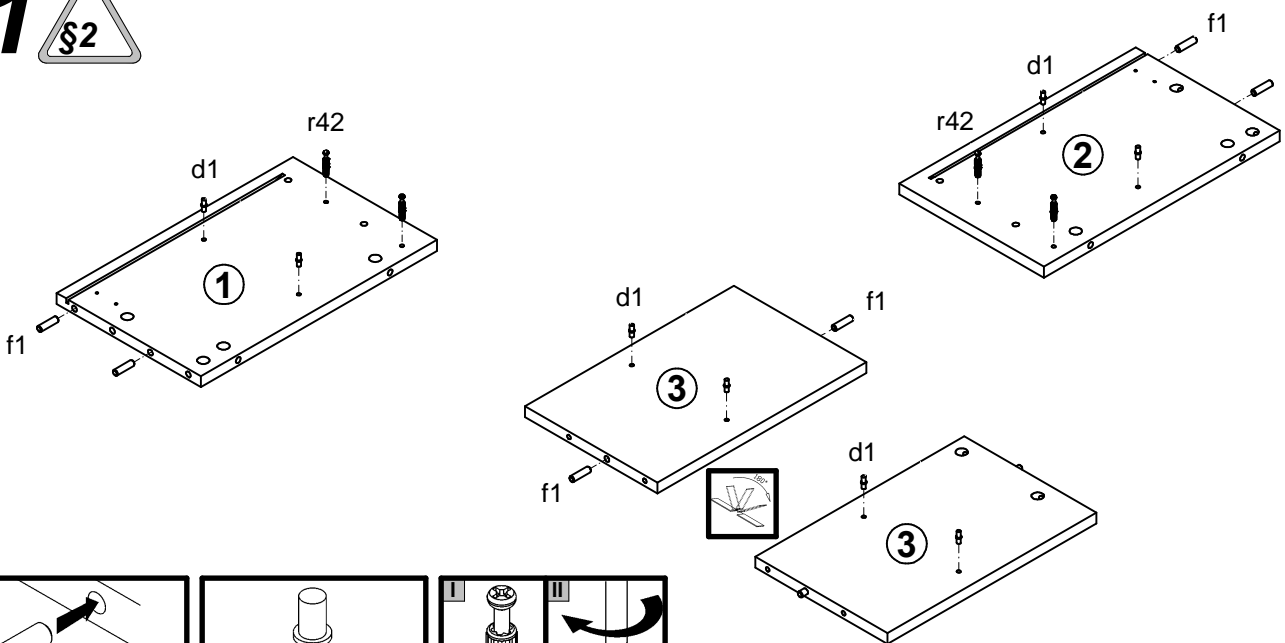

5

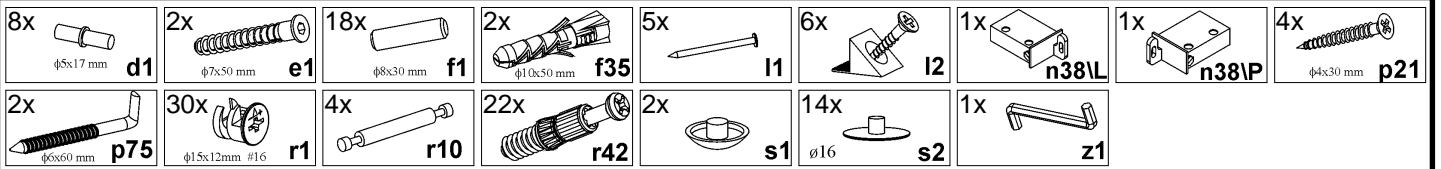
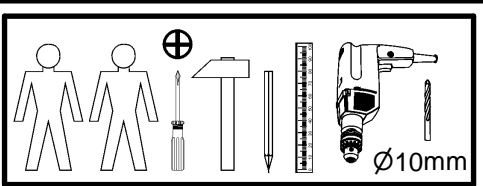
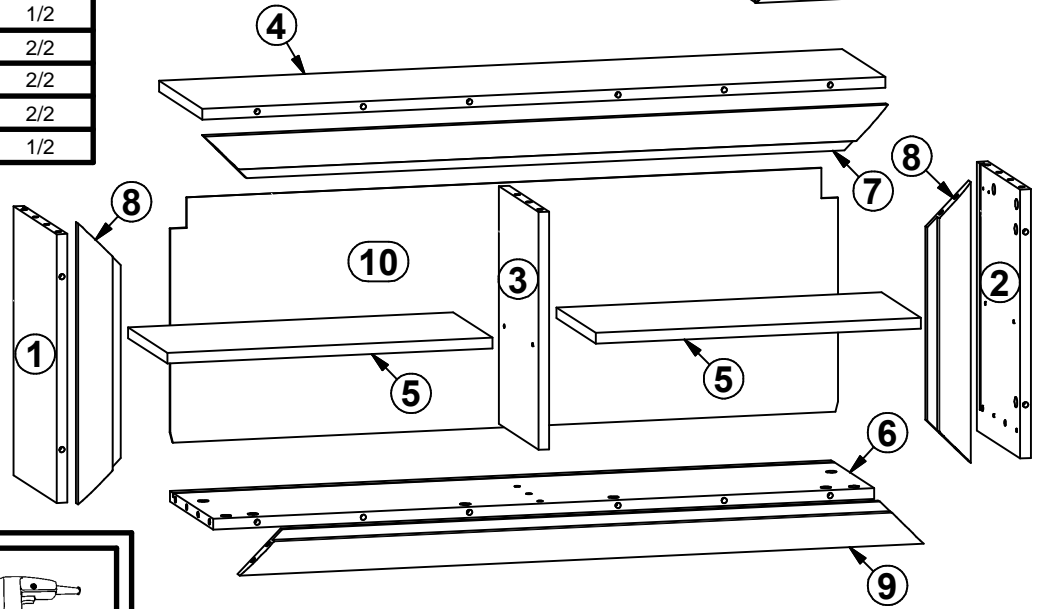
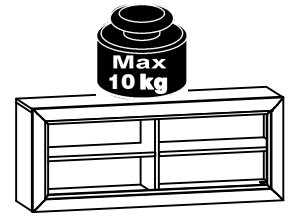
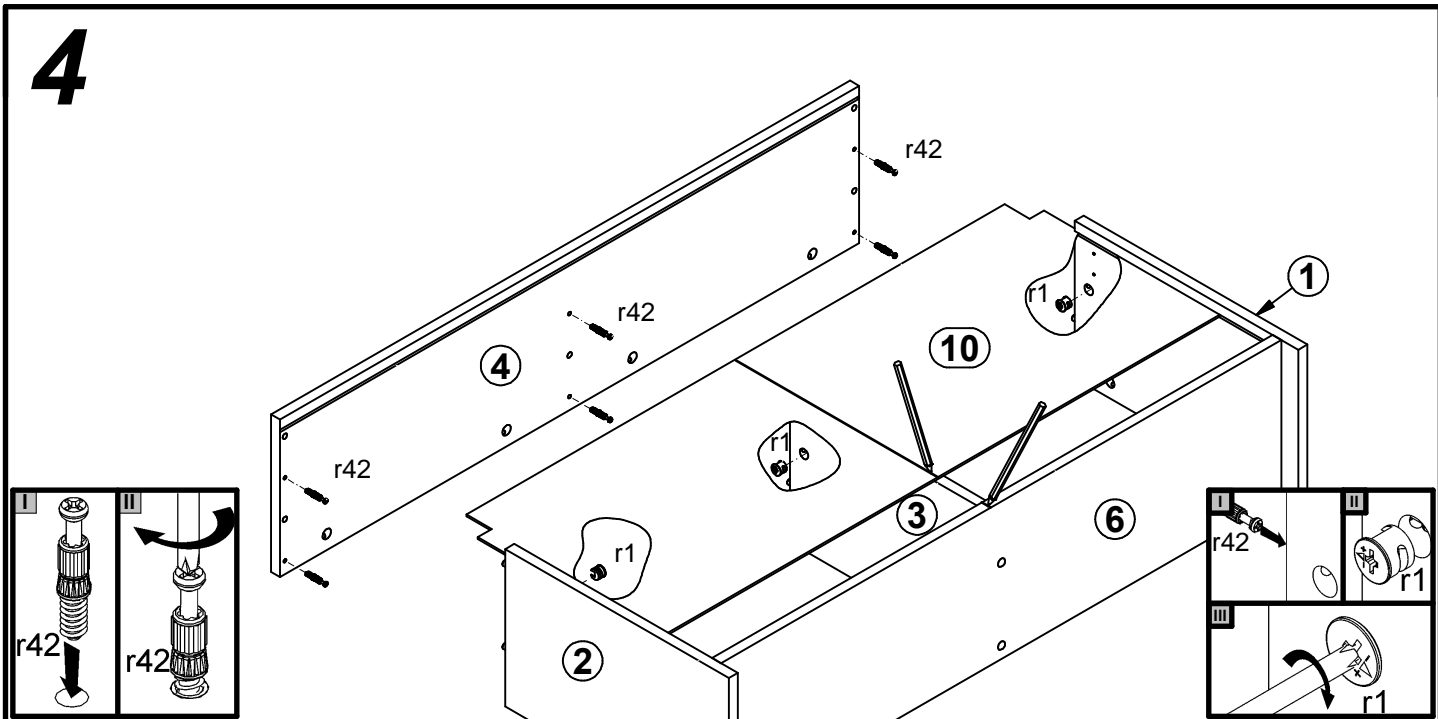
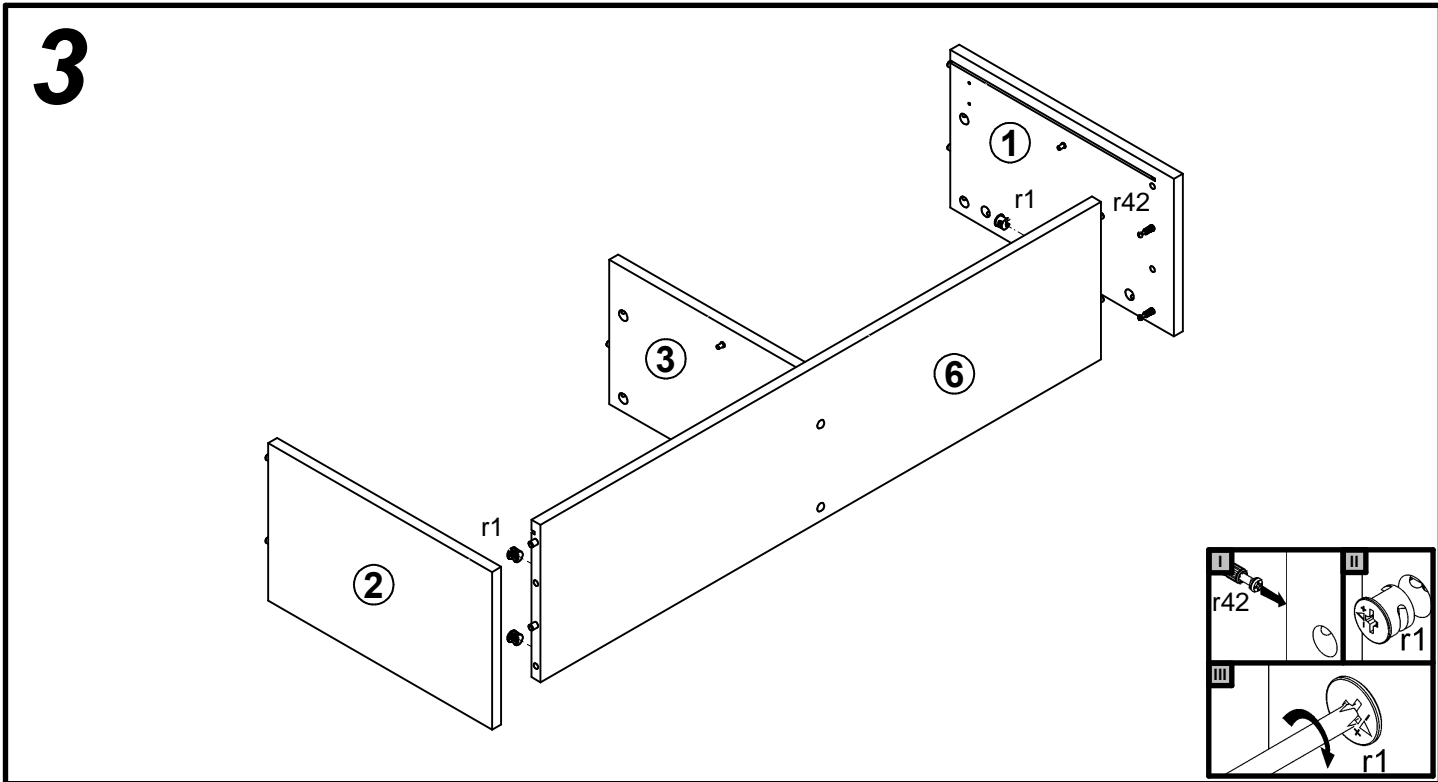
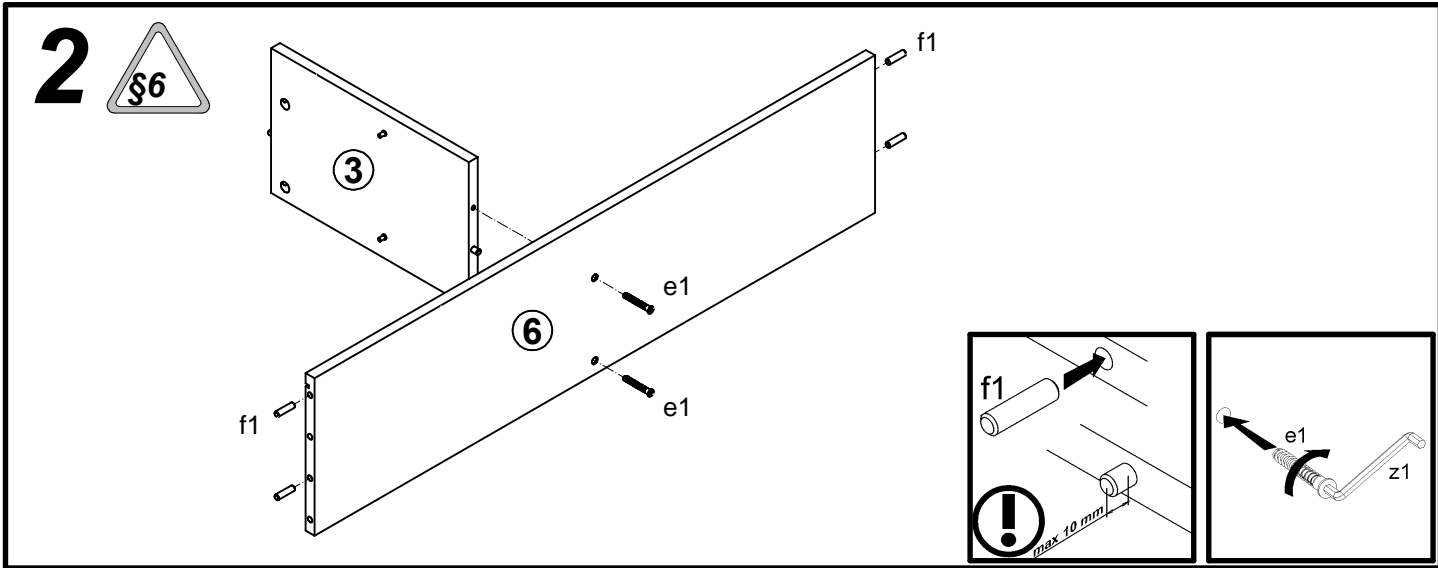
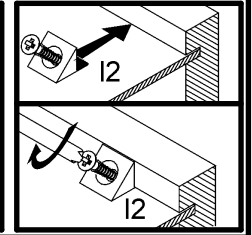
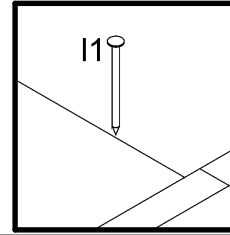
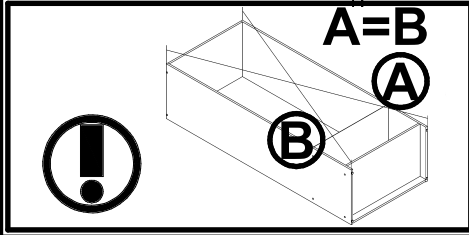
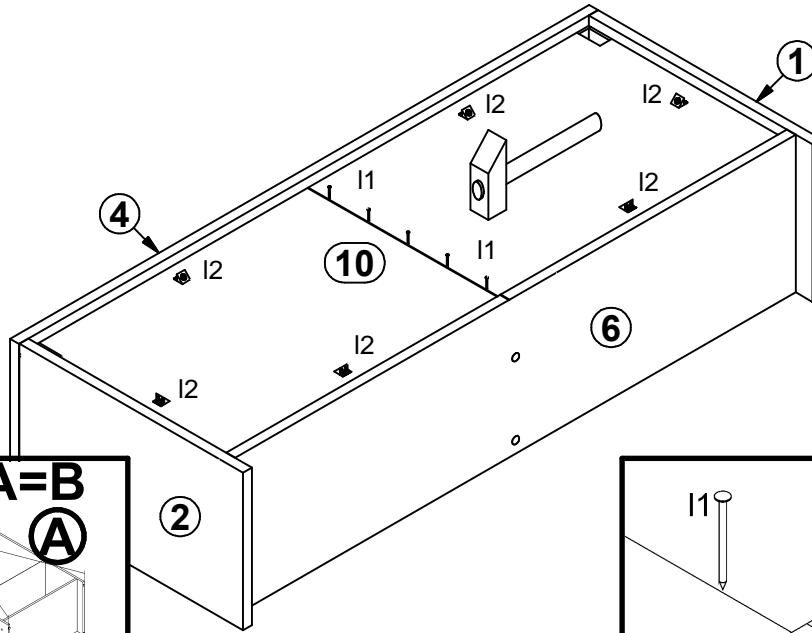

6

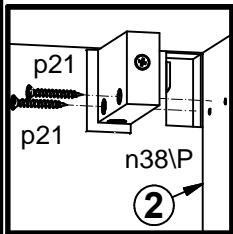
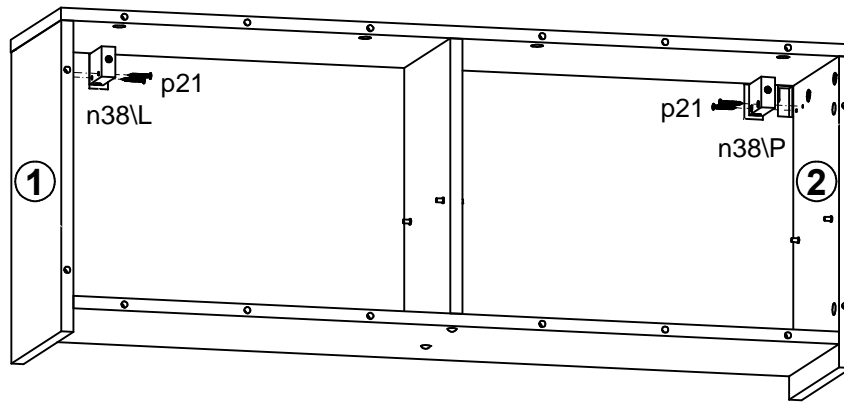

7

