

A	B	C	D
1	F14-701	980	717
2	F14-705	980	717
3	F14-708	980	717

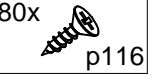

1 §2 §6

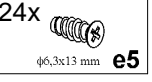
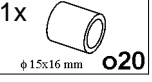
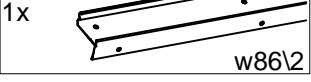
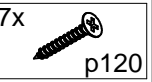
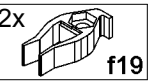
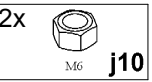
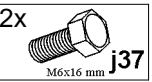
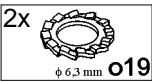
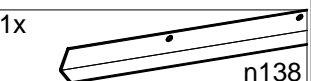
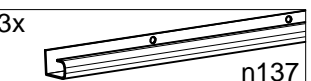
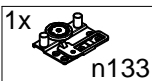
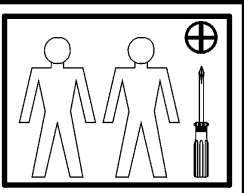
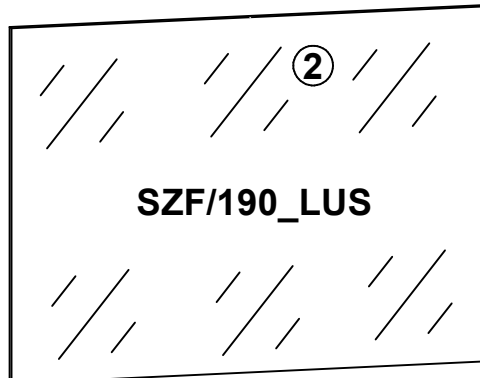
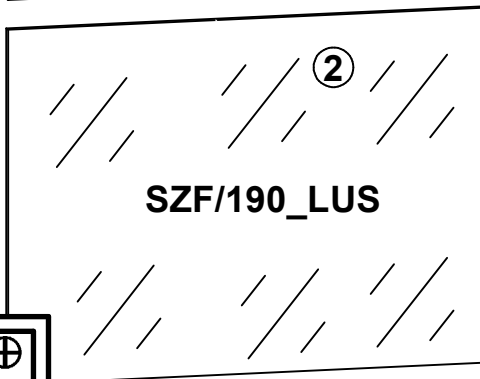
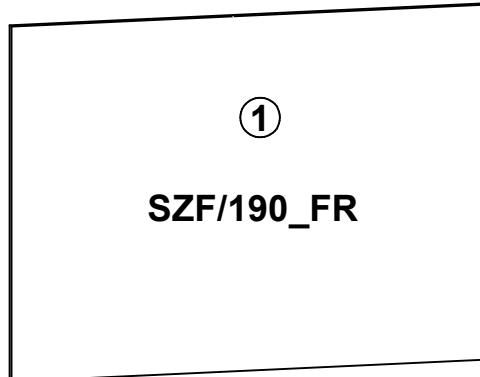
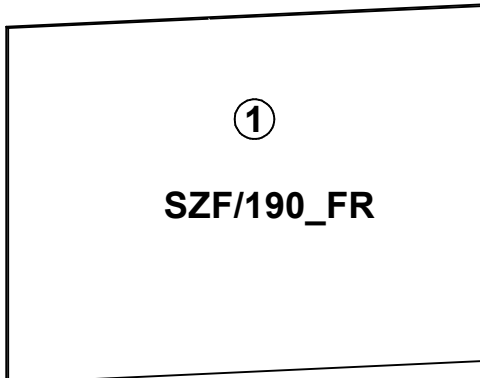
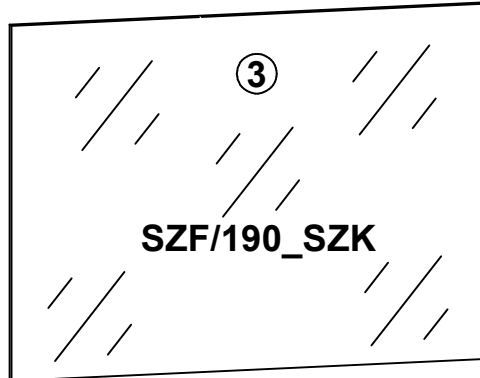
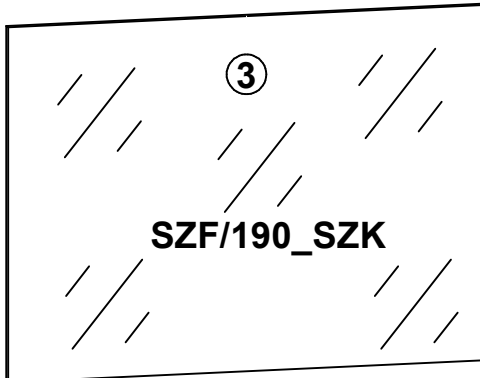
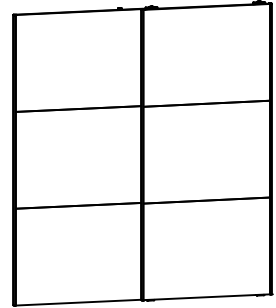
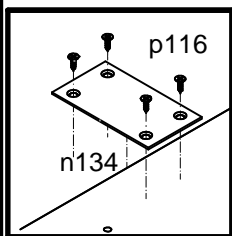
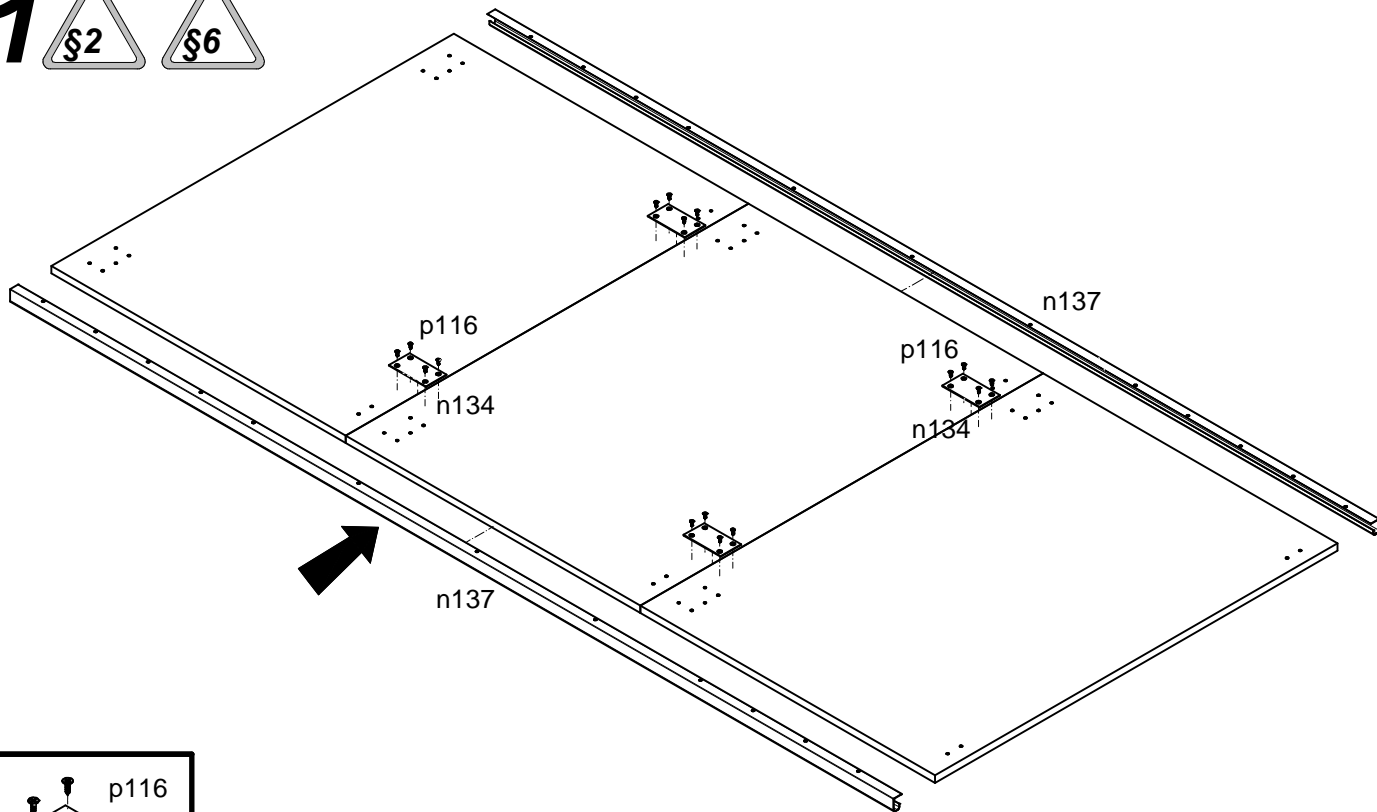

2

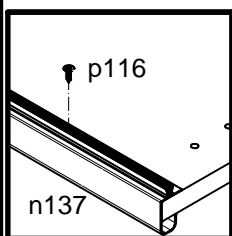
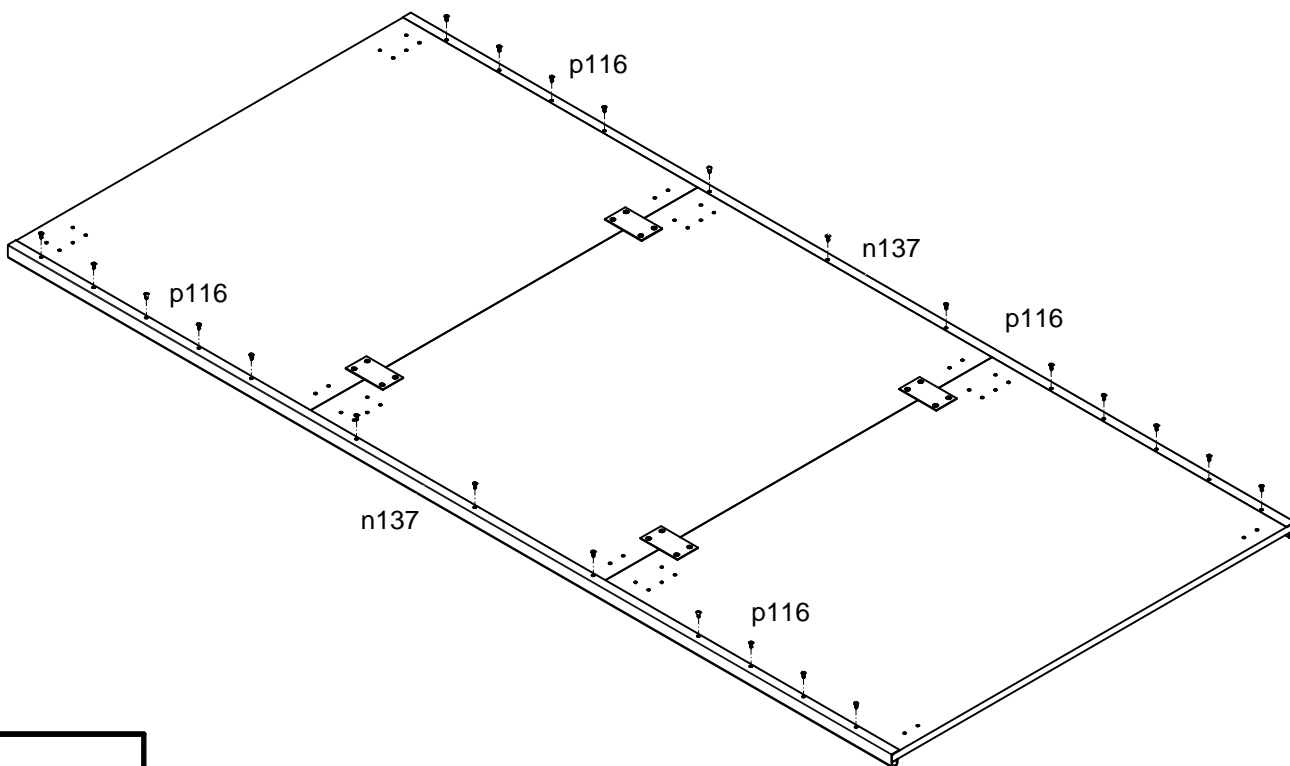

3

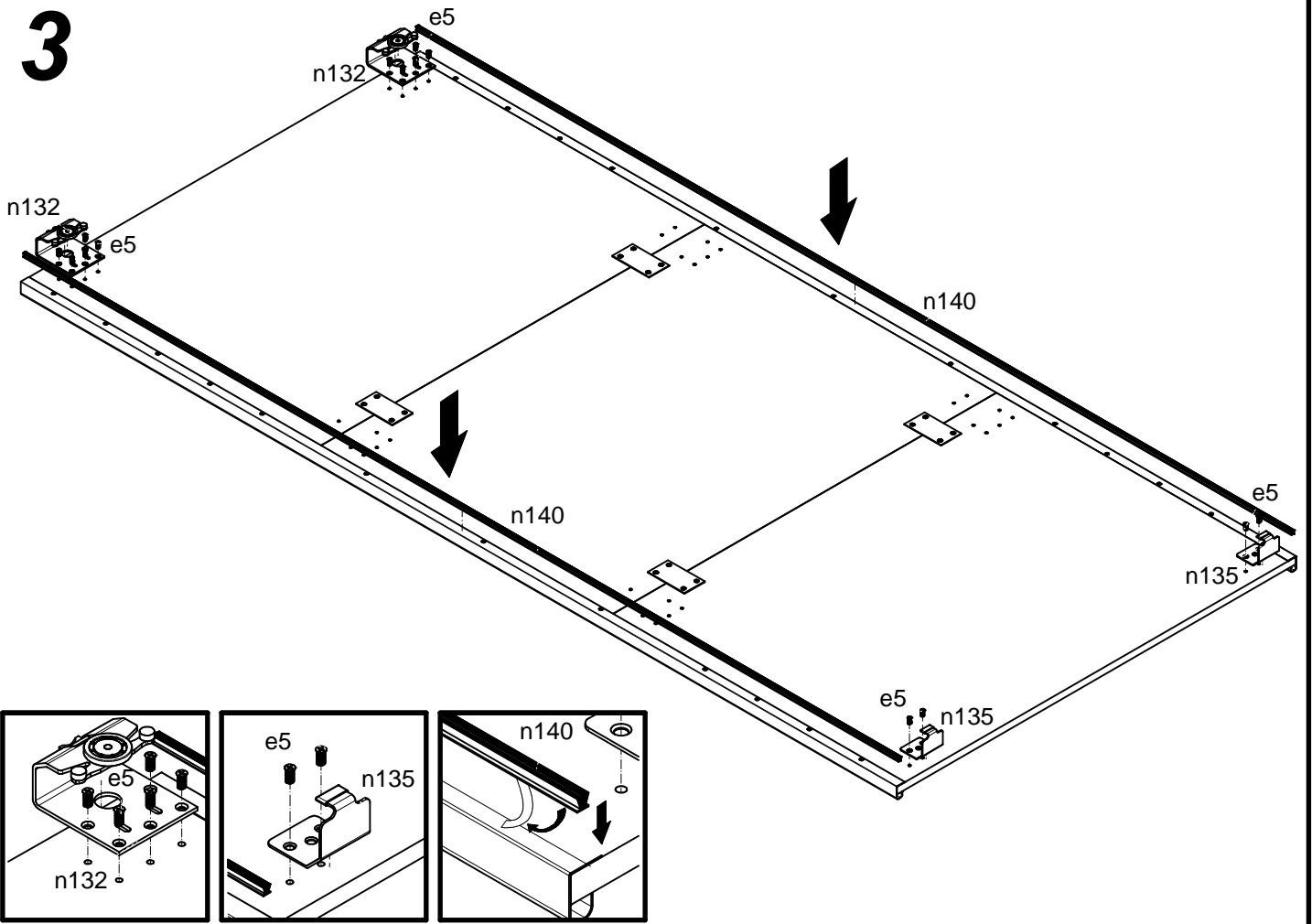

4

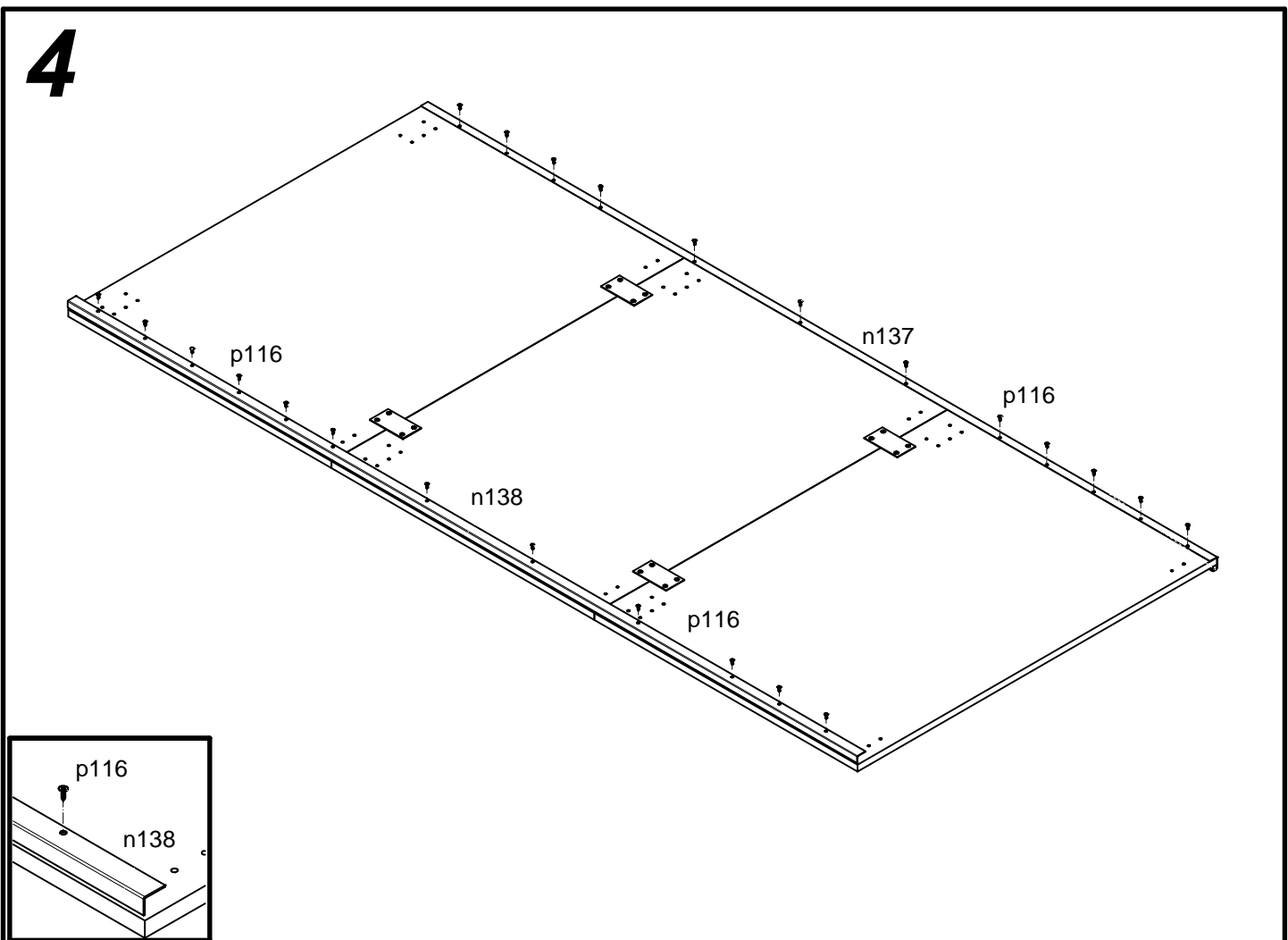

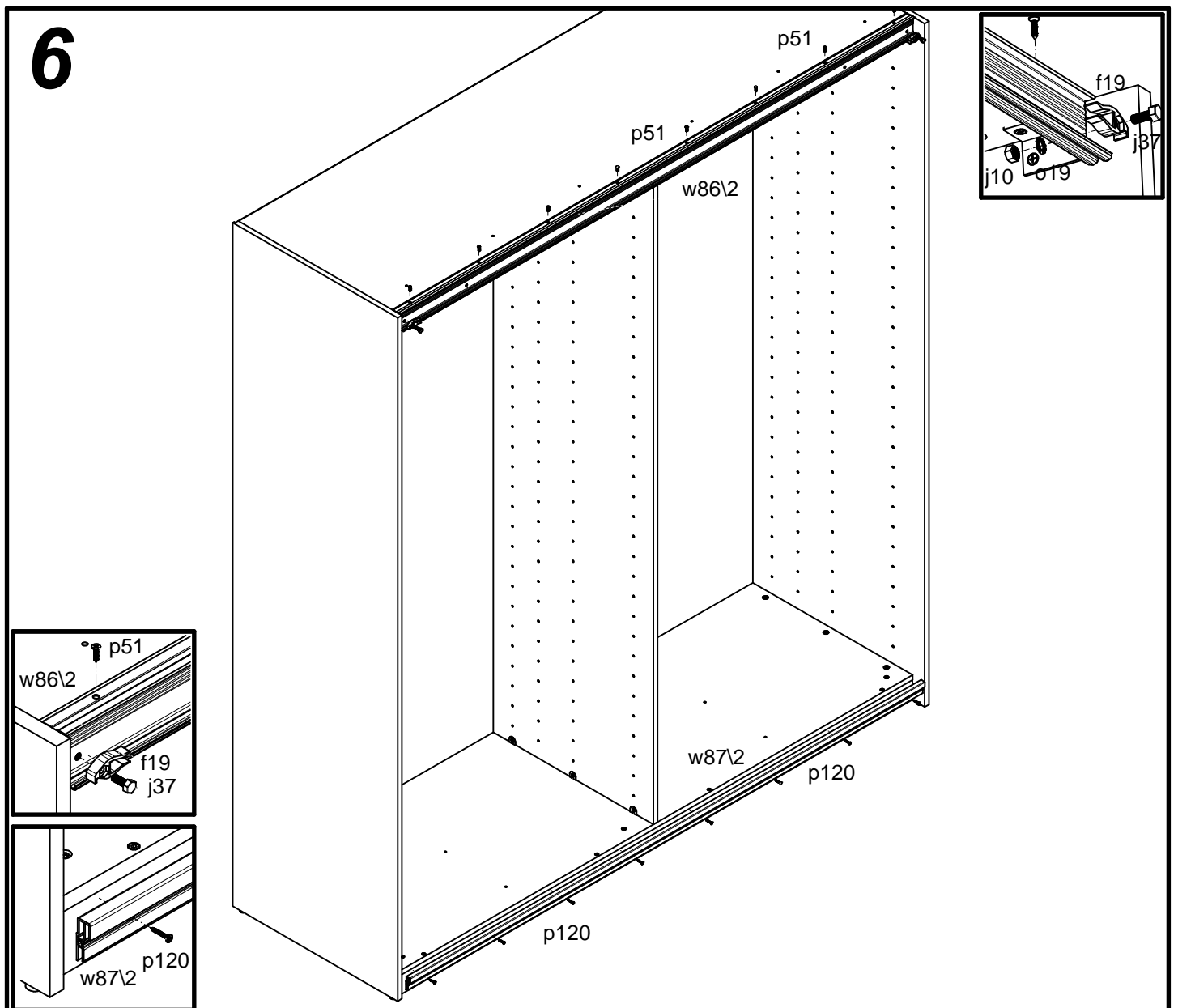
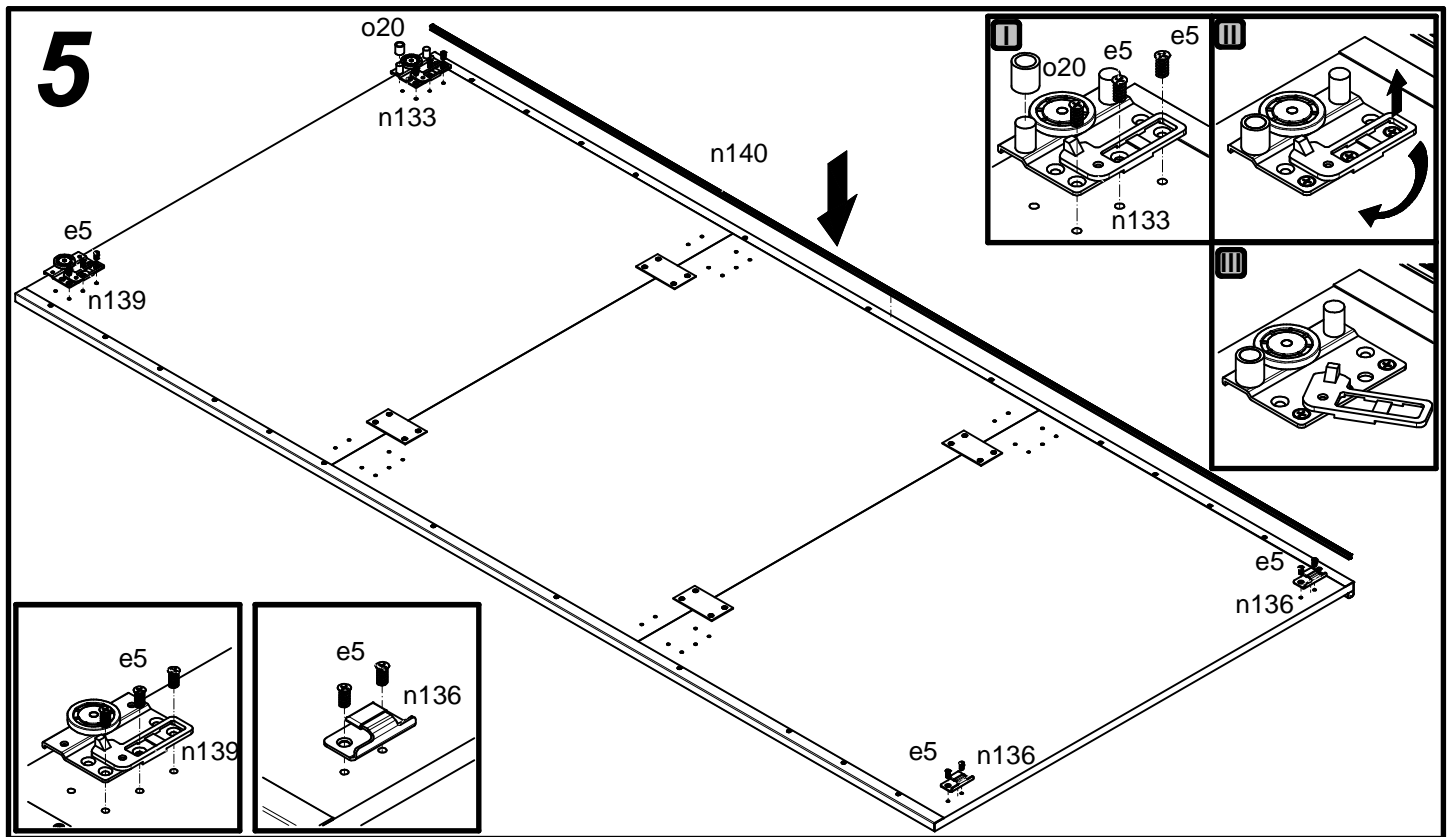

7

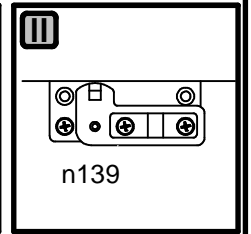
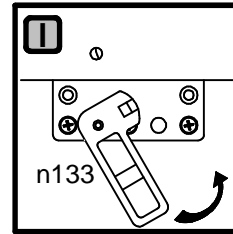
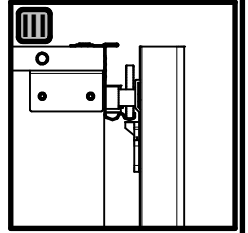
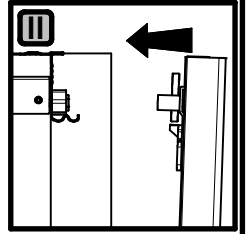
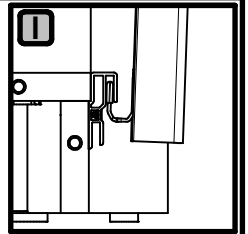
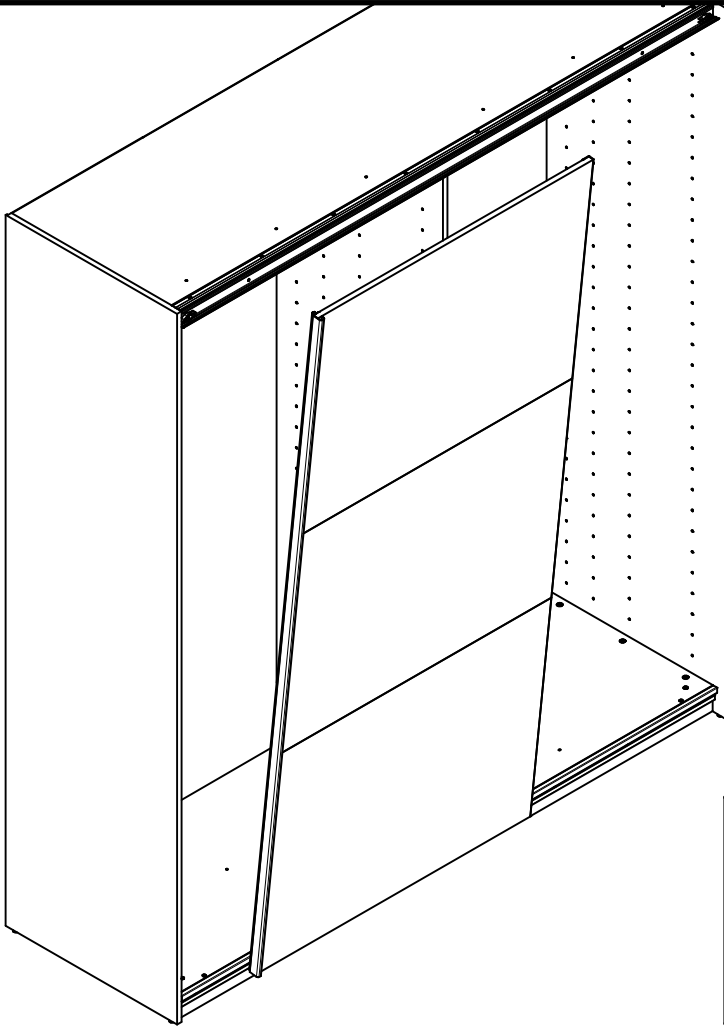

8

