

A	B	C	D	A	B	C	D		
1	S320-003	764	446	4/5	11	S320-541	441	270	3/5
2	S320-029	764	446	4/5	12	S320-506	441	270	3/5
3	S320-004	596	188	5/5	13	S320-903	798	597	1/5
4	S320-103	772	403	1/5	14	S320-904	798	449	1/5
5	S320-104	772	403	1/5	15	S320-905	538	398	1/5
6	S320-105	772	403	1/5	16	S320-575	80	38	1/5
7	S320-106	772	403	1/5	17	S320-569	400	120	1/5
8	S320-203	1540	436	2/5	18	S320-570	400	120	1/5
9	S320-204	1512	425	2/5	19	S320-5547	523	120	1/5
10	S320-302	427	399	1/5	20	S320-5546	383	60	1/5

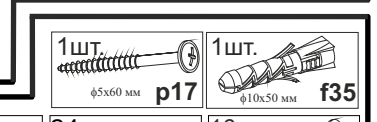

4x a44	4x b19	6x c35\1	6x c35\2	8x d1	9x e8	24x e3	24x f1	16x e1
4x j29	2x j11	80x l1	28x r42	4x w5\CL	4x w5\CR	4x w5\DL	4x w5\DR	1x z1
16x e19	8x e2	12x e26	8x p51	24x r1	4x r15	1x n26\1	1x p38	22x s2

1

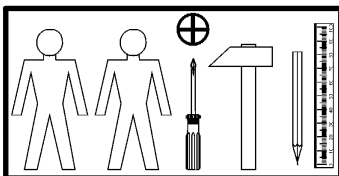
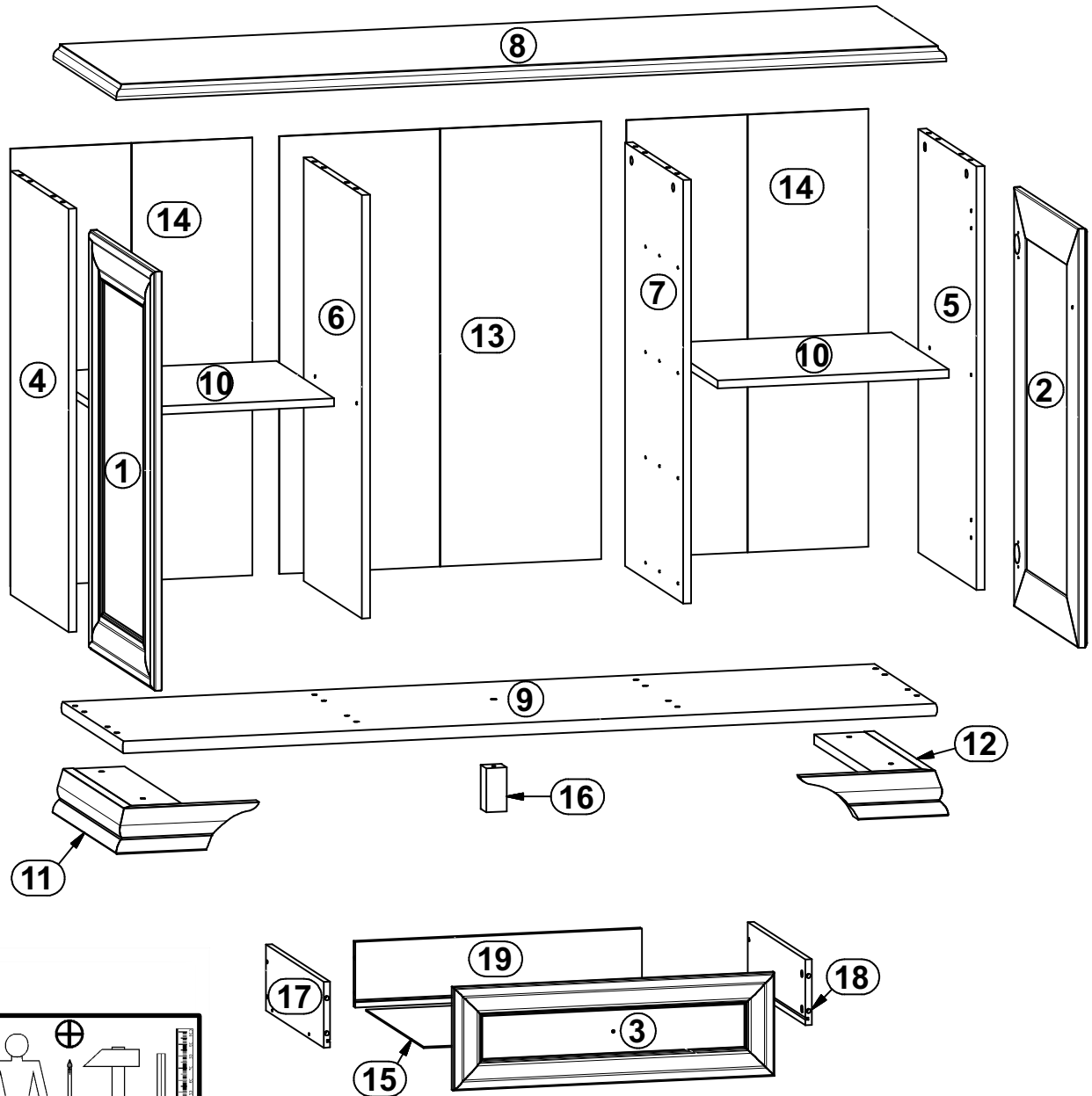
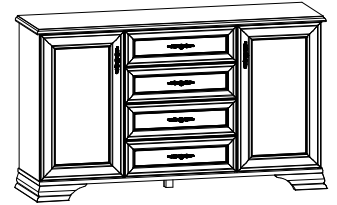
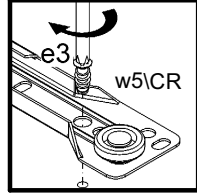
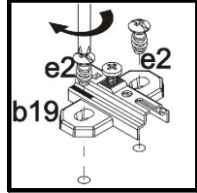
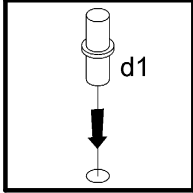
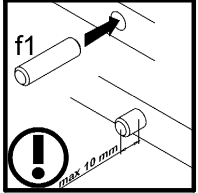
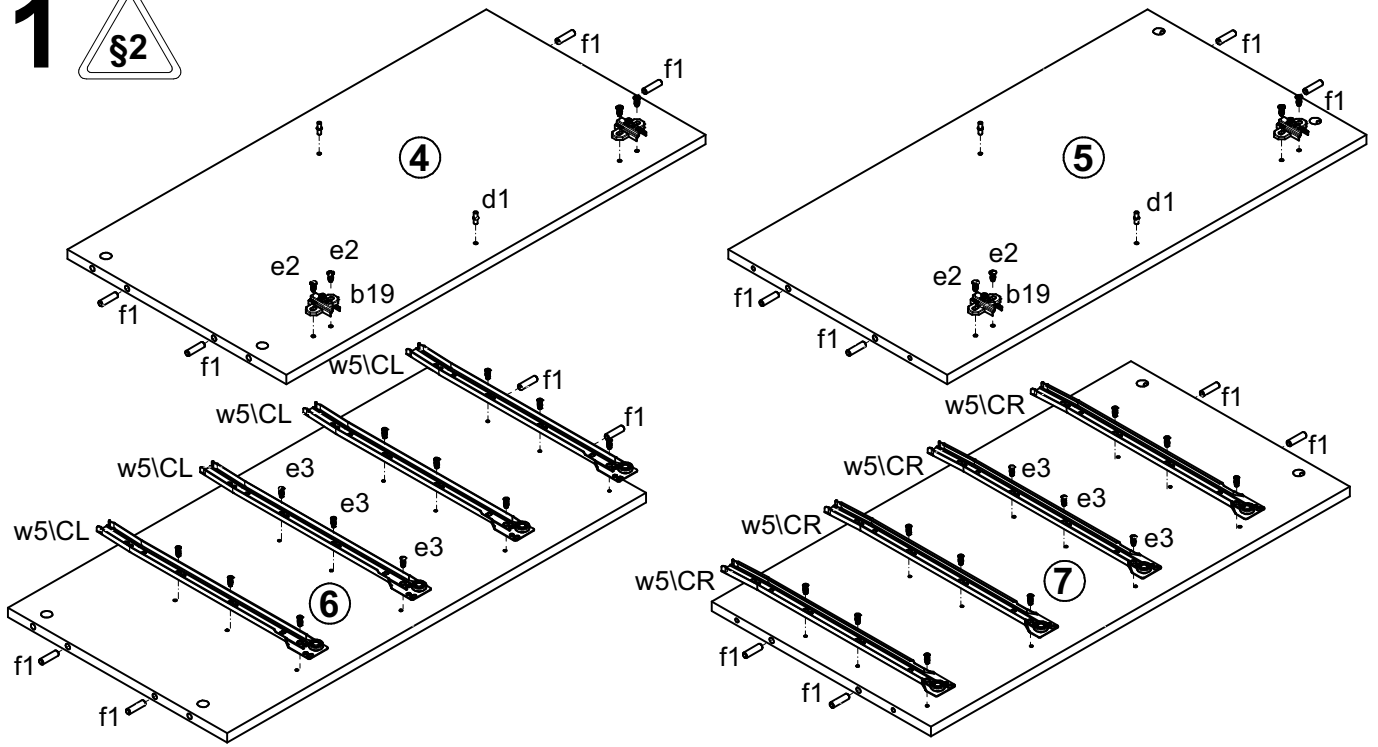

2

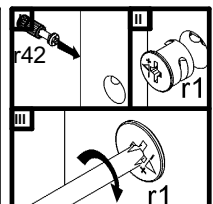
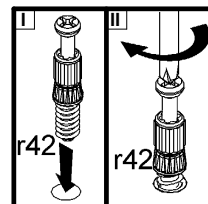
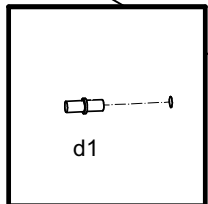
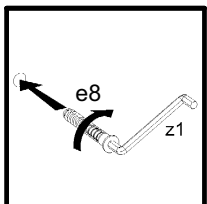
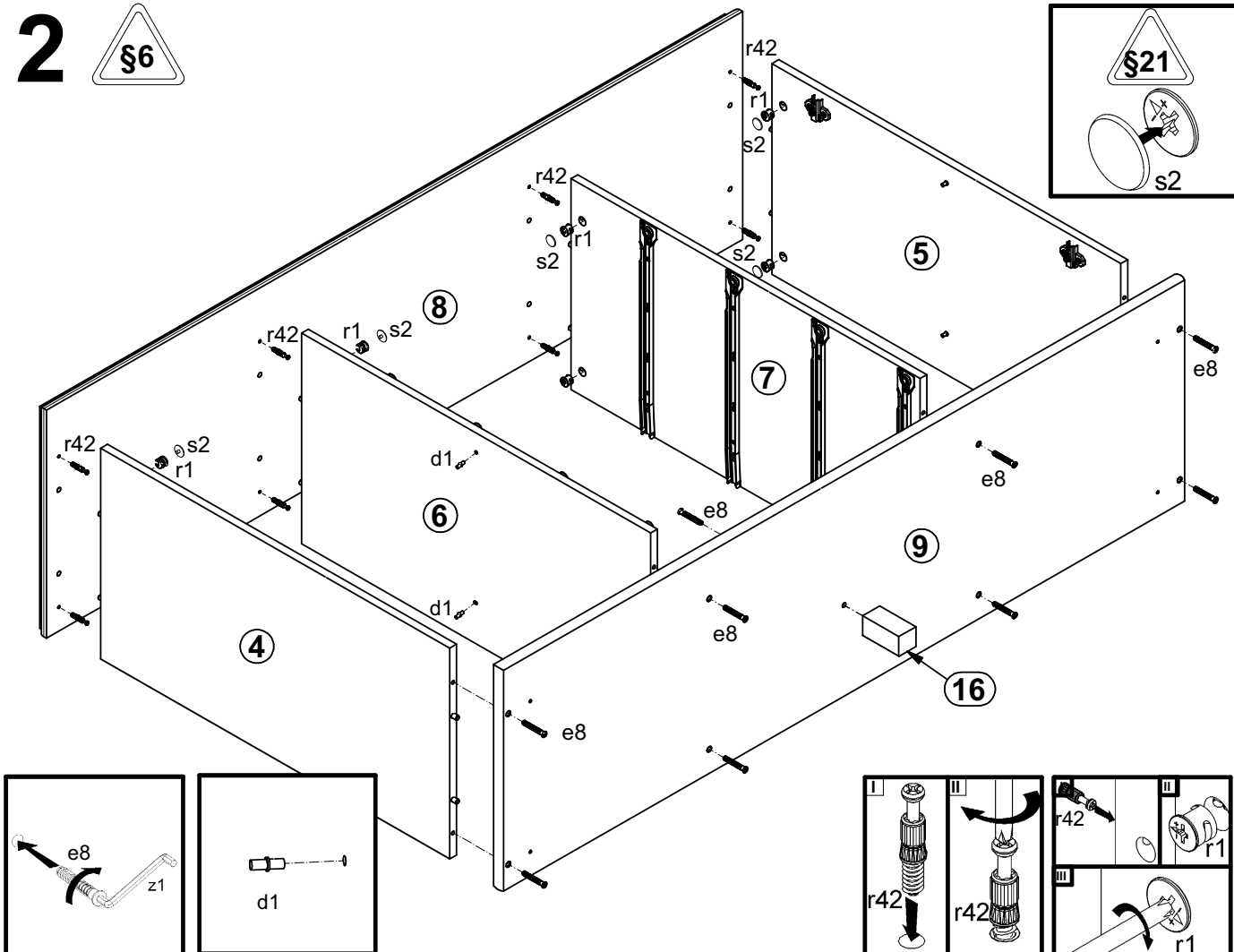
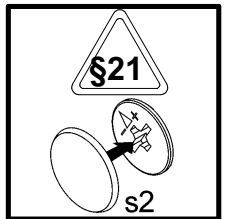

3

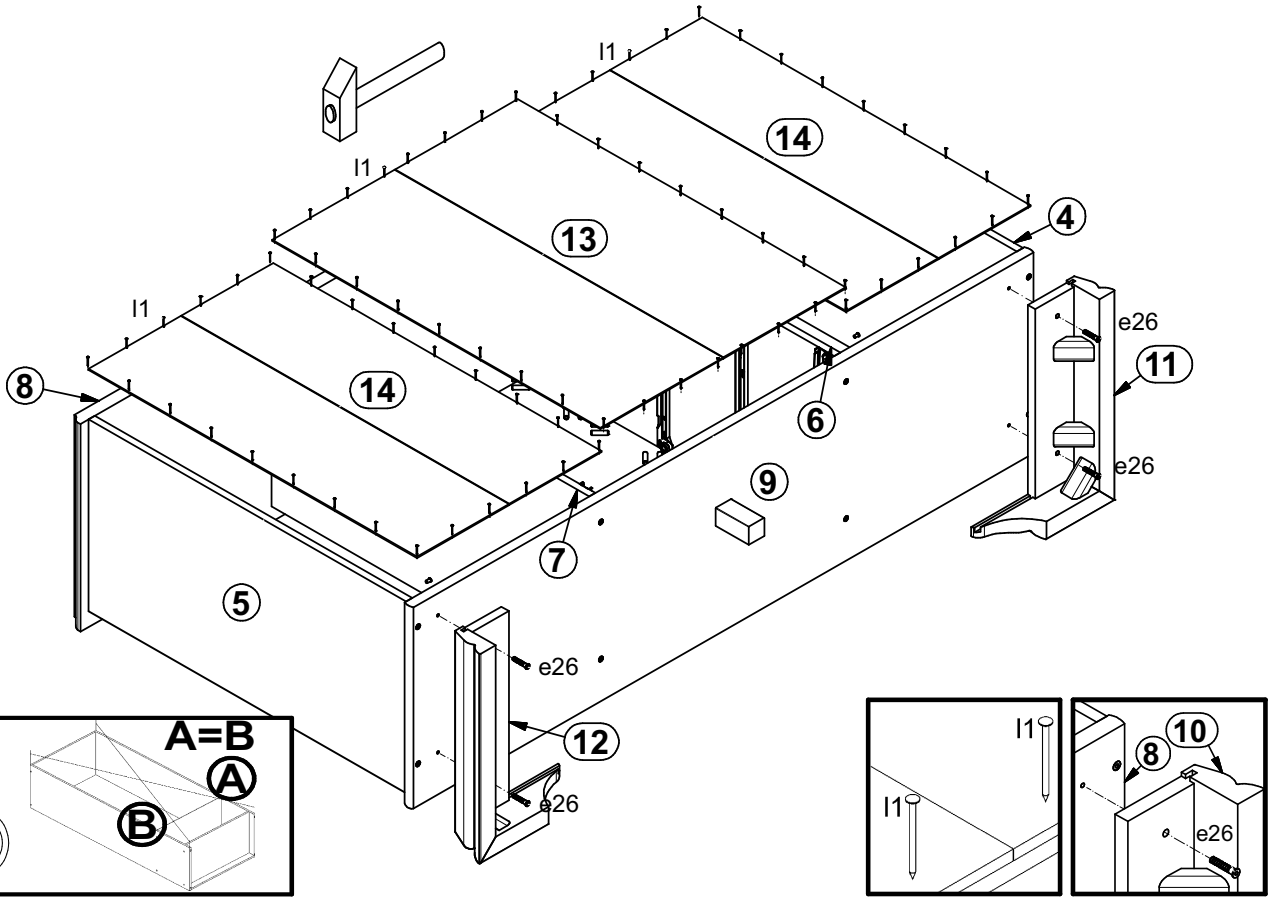

4

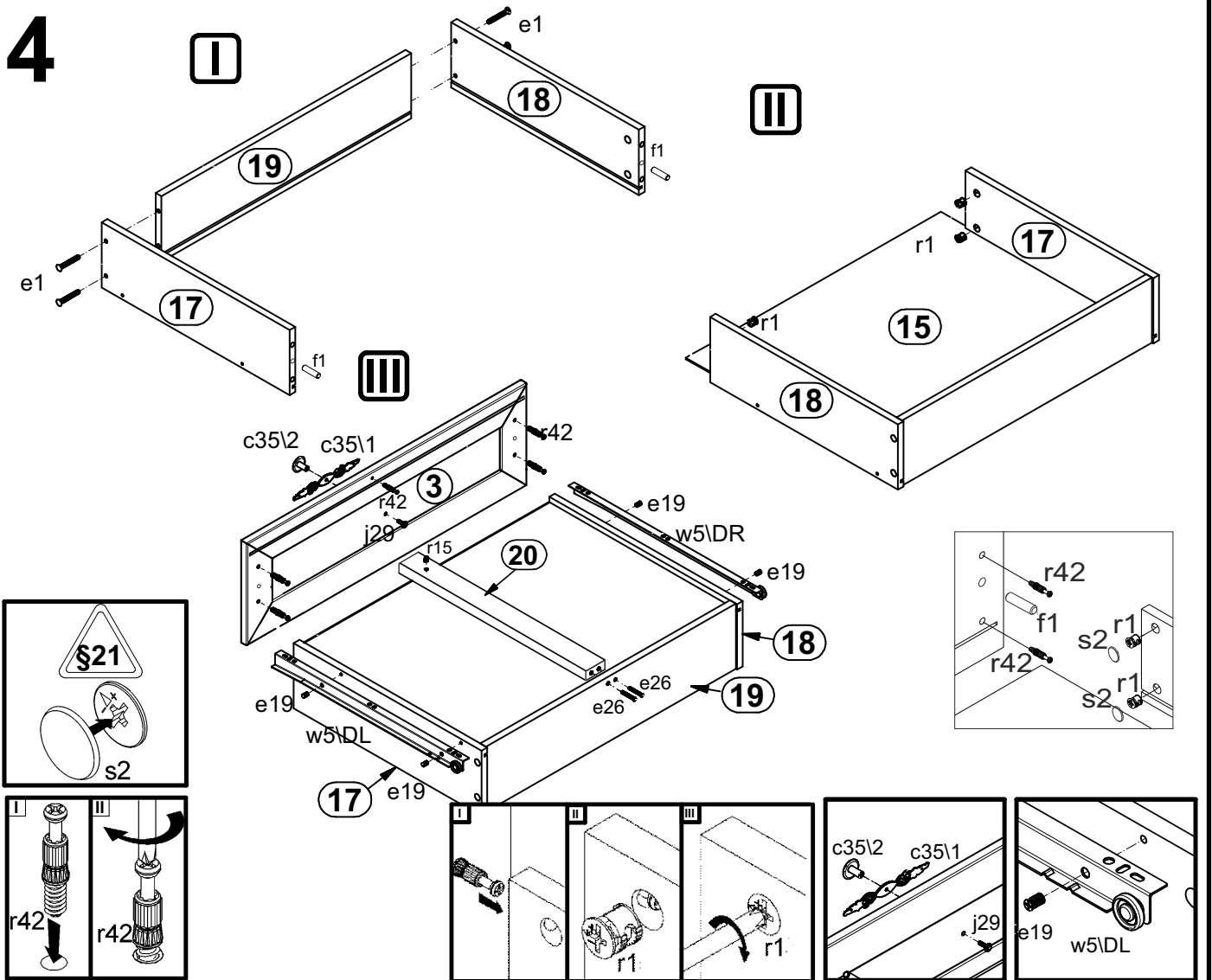

5

