

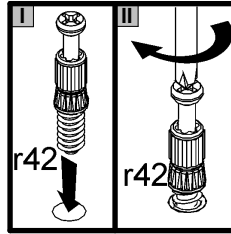

**1** §2

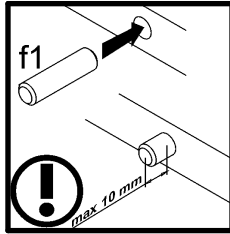

**2** §6

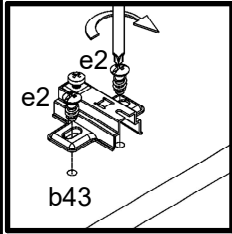
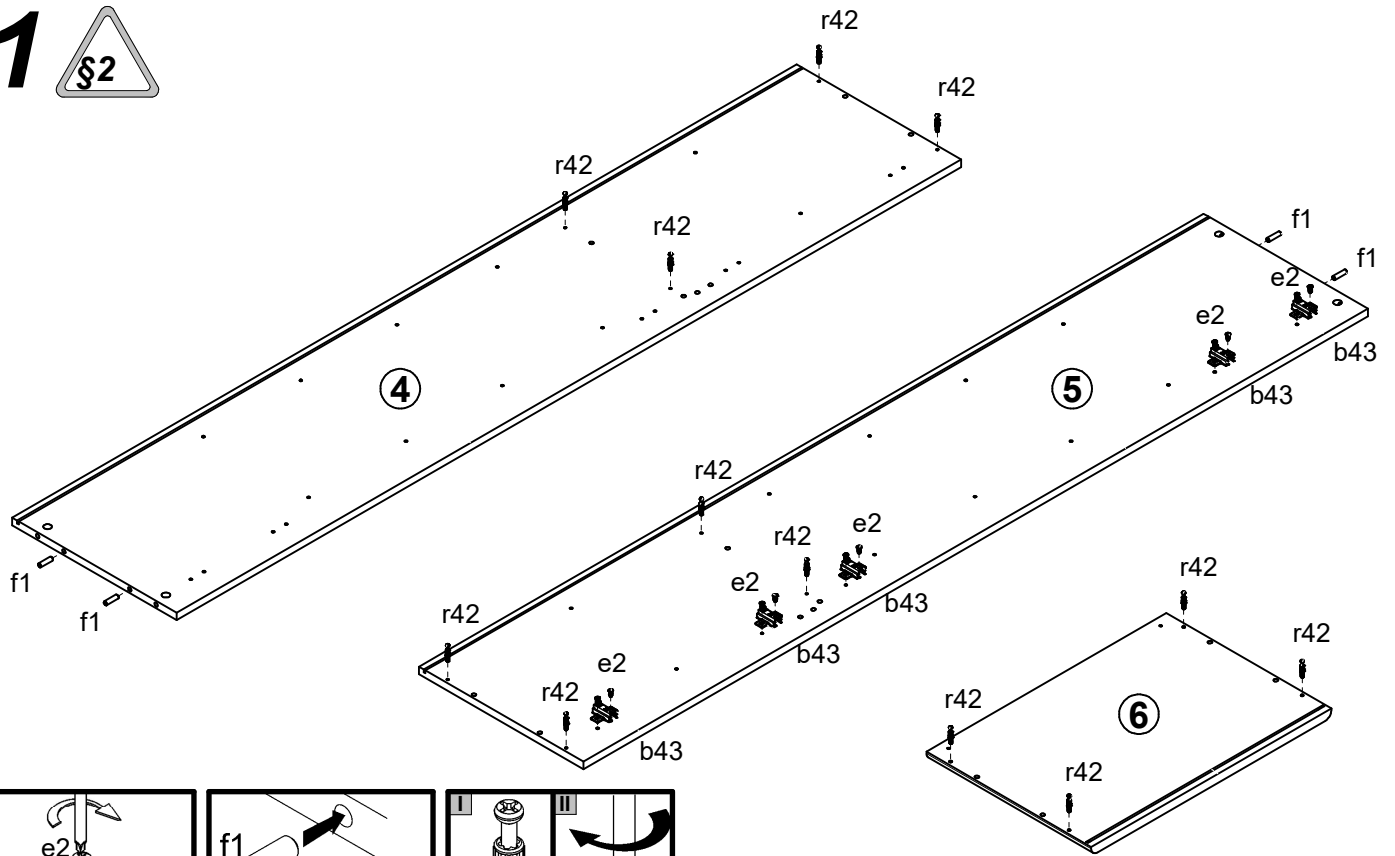
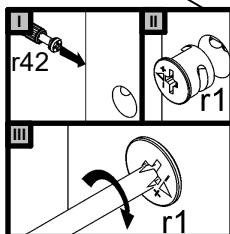
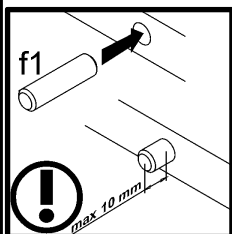
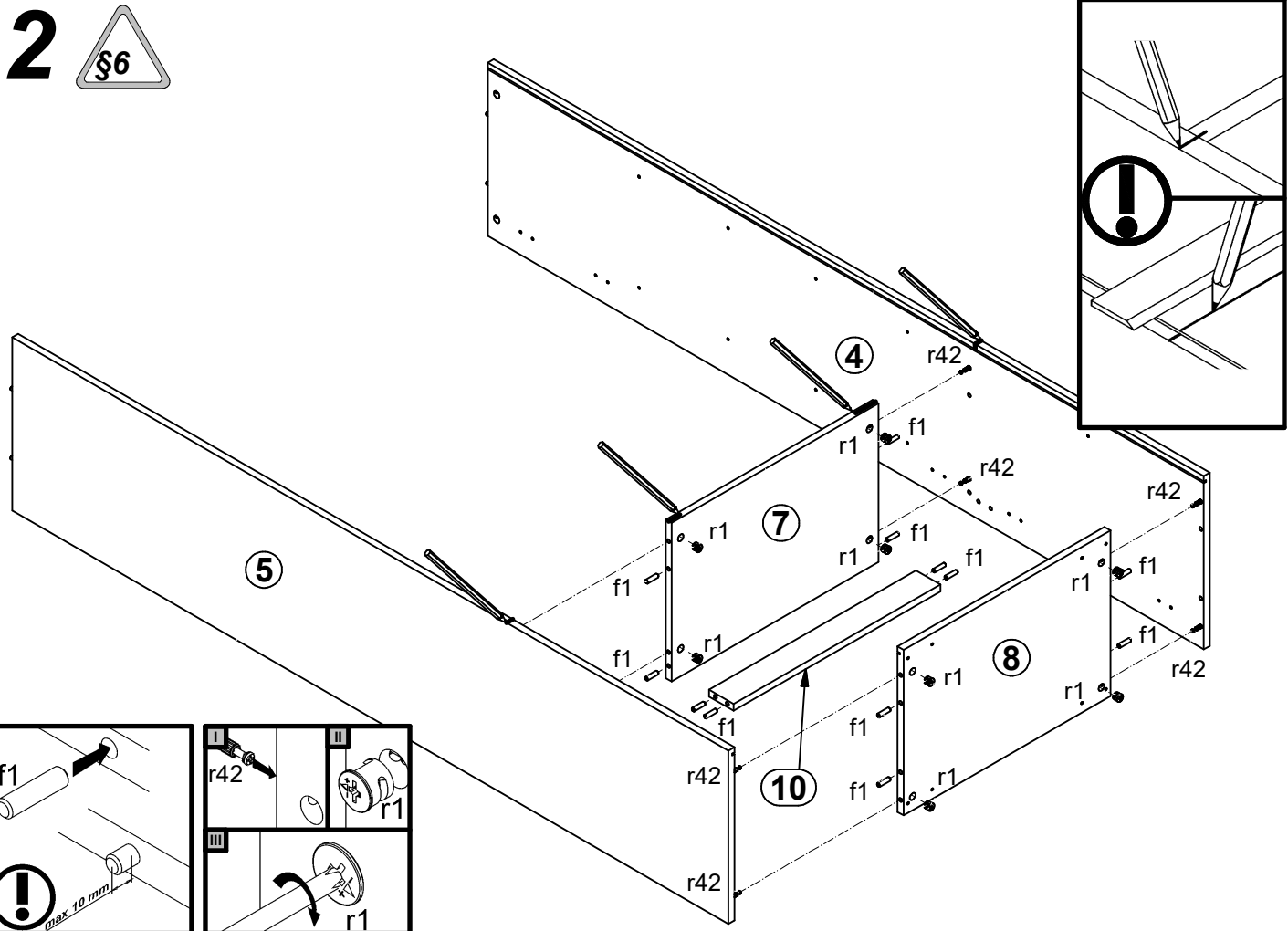

# 3

I

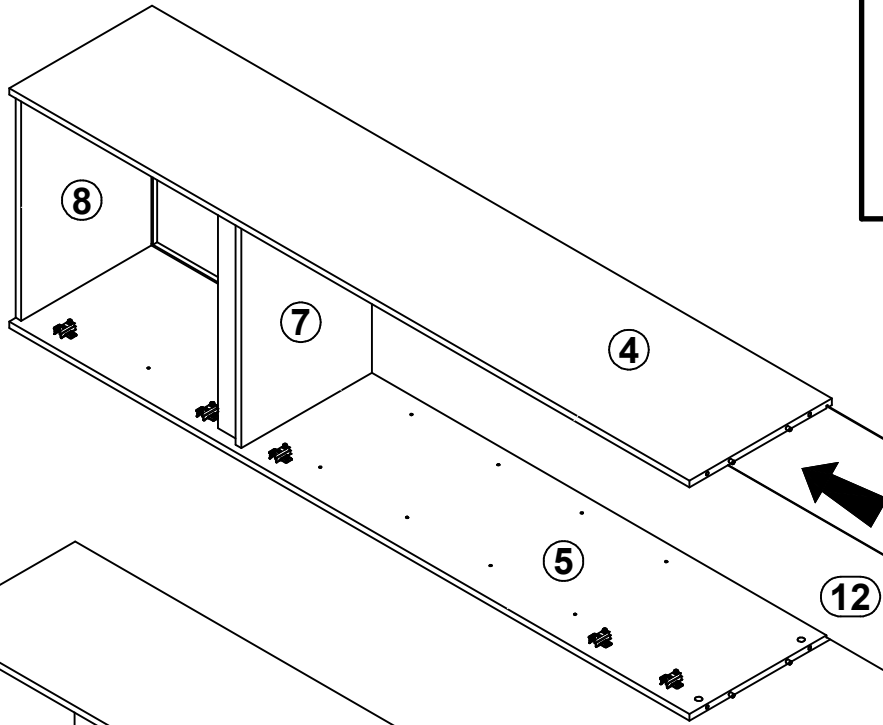

II

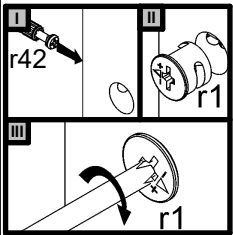
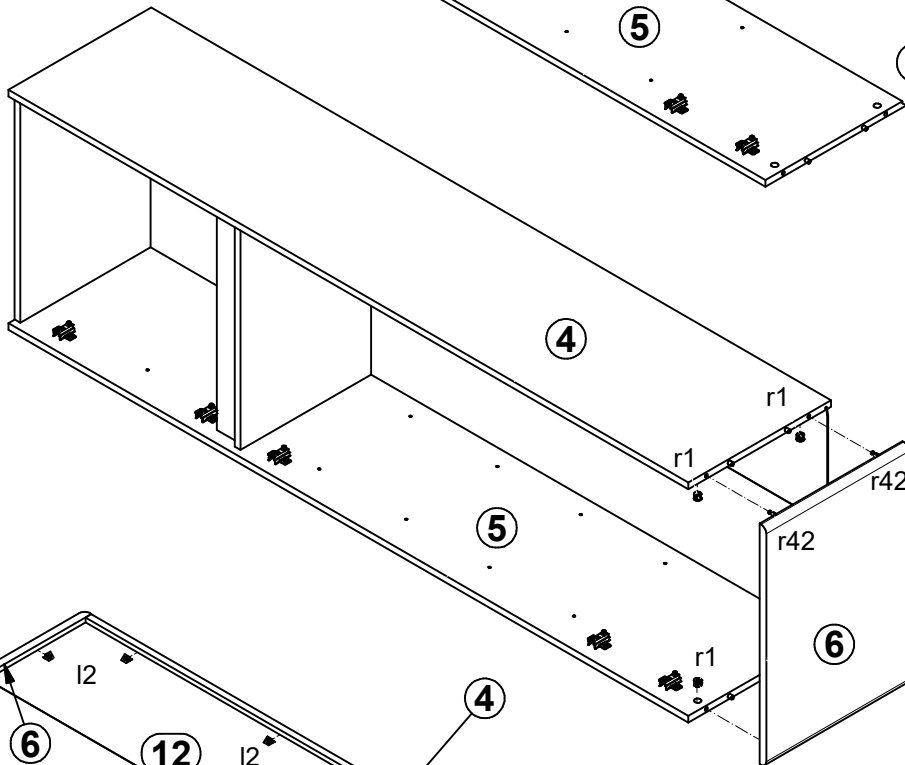

III

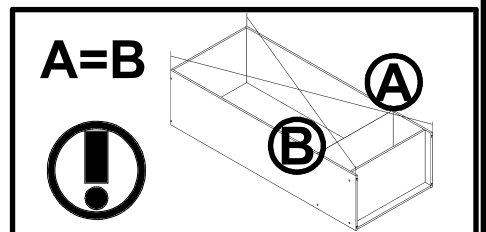
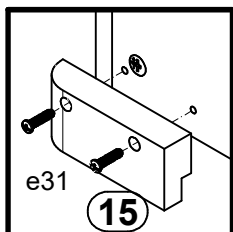
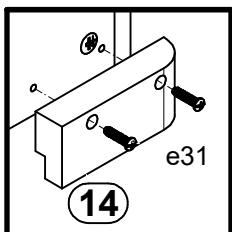
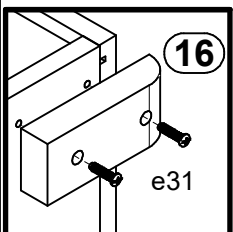
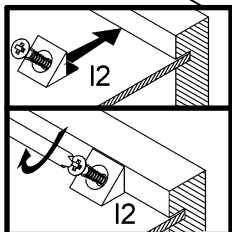
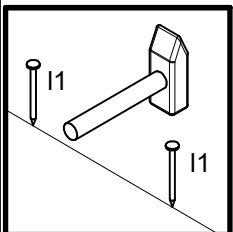
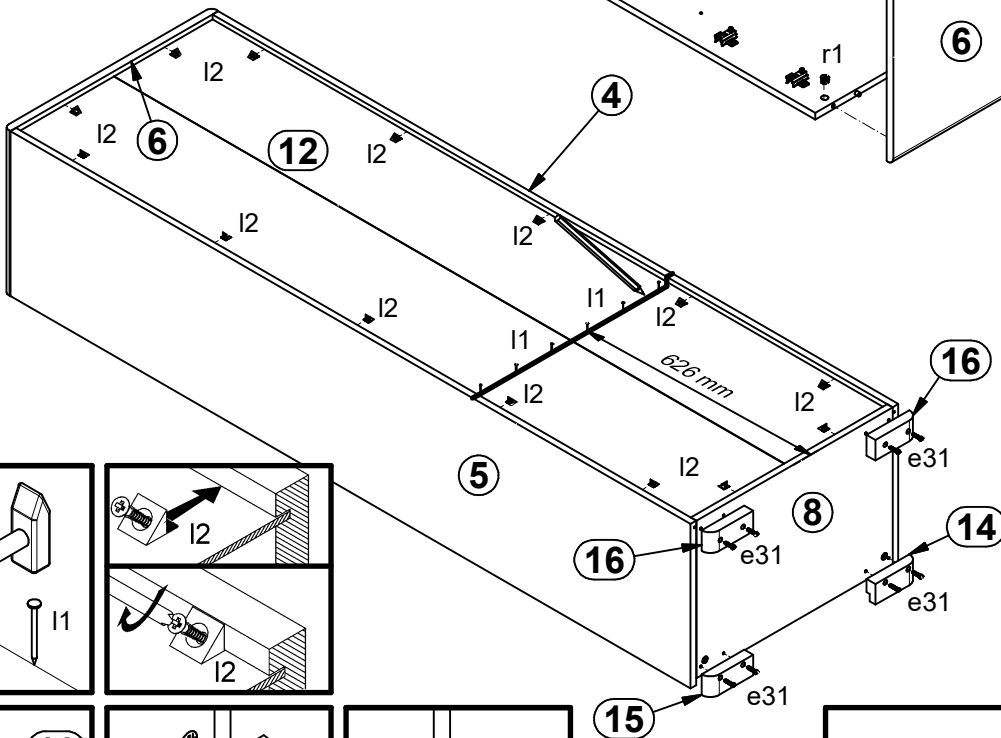

# 4



A=B

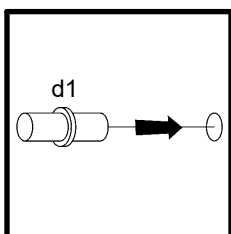
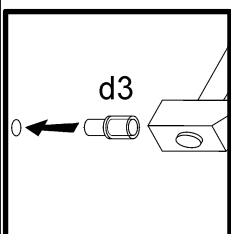
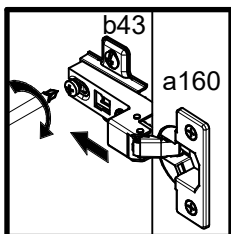
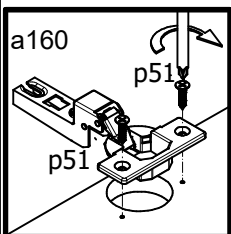
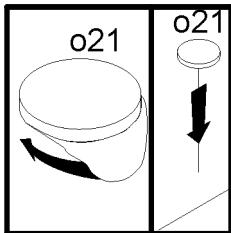
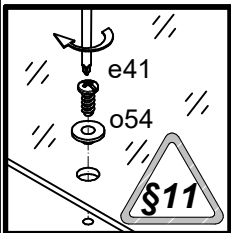
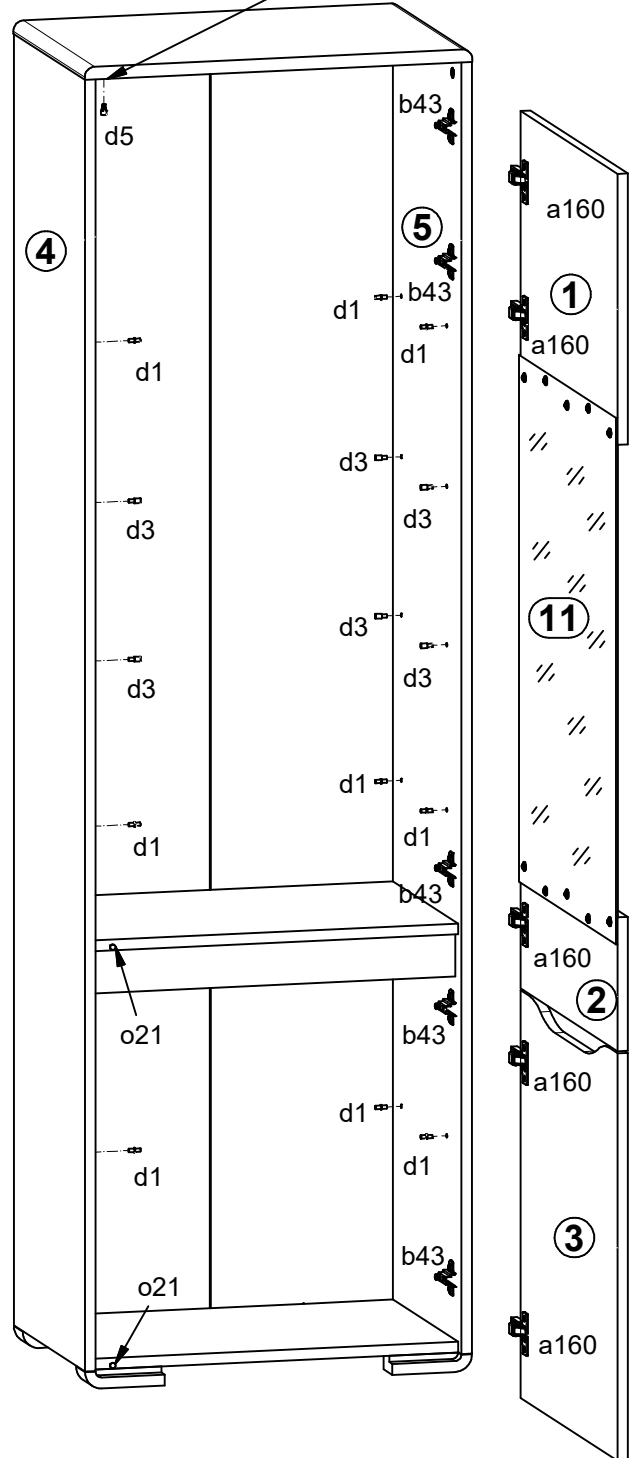
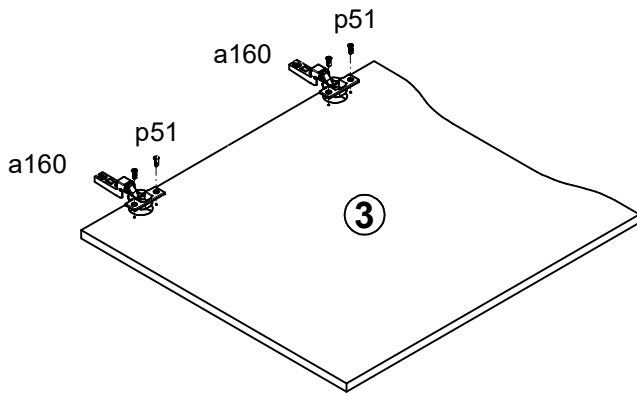
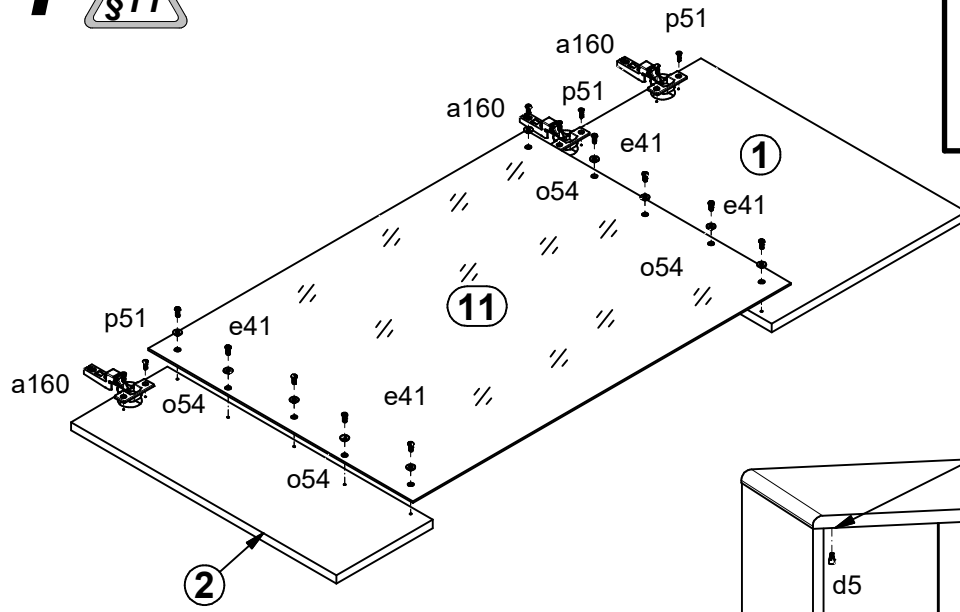
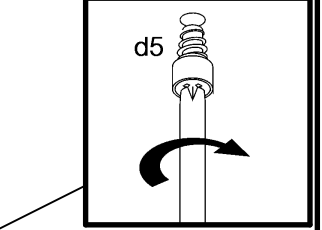

# 5

