

- D** Montageanleitung
- NL** Handleiding voor de montage
- TR** Montaj talimatı
- FR** Instructions de montage
- CZ** Montážní návod
- HU** Összeszerelési útmutató
- GB** Assembly instructions
- PL** Instrukcja montażu
- RU** Инструкция по монтажу
- IT** Istruzioni di montaggio
- RO** Instructiuni de asamblare
- SK** Montážny návod

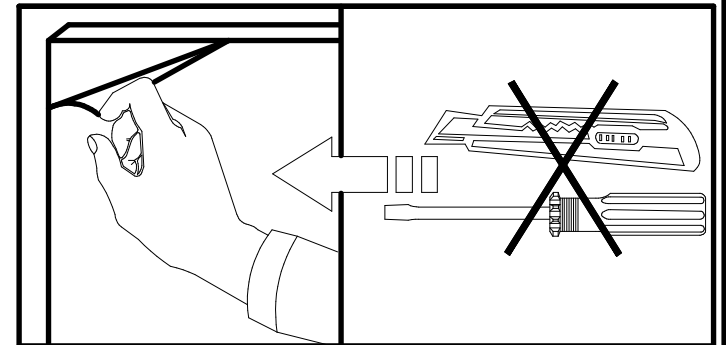

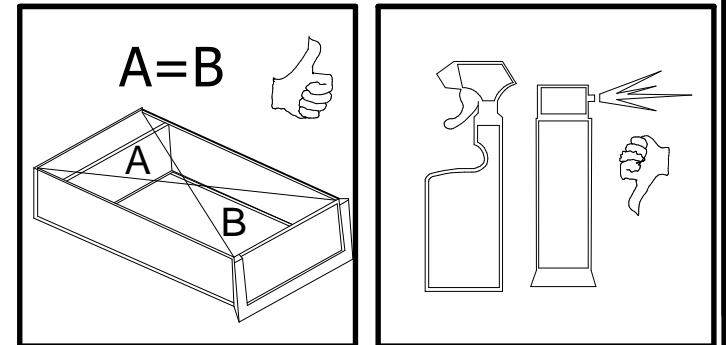

A	B	C (mm)		D
1	S215-013	482	176	2/2
2	S215-116	1091	399	1/2
3	S215-117	1091	399	1/2
4	S215-311	488	397	1/2
5	S215-312	488	358	1/2
6	S215-406	488	60	1/2
7	S215-407	488	60	1/2
8	S215-9907	1015	499	1/2
9	WSP-906	458	308	1/2
10	WSQ2-503	300	100	1/2
11	WSQ2-504	300	100	1/2
12	WTQ-5013	448	87	1/2

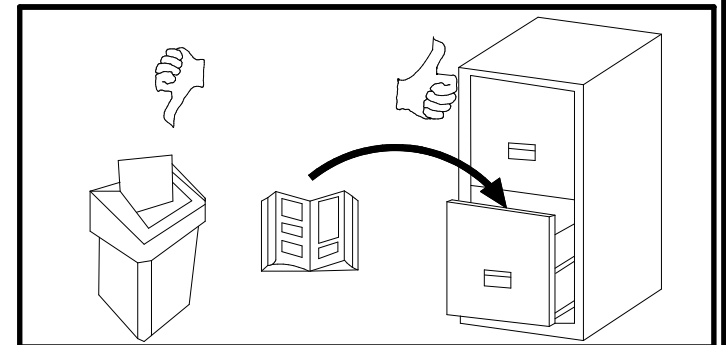
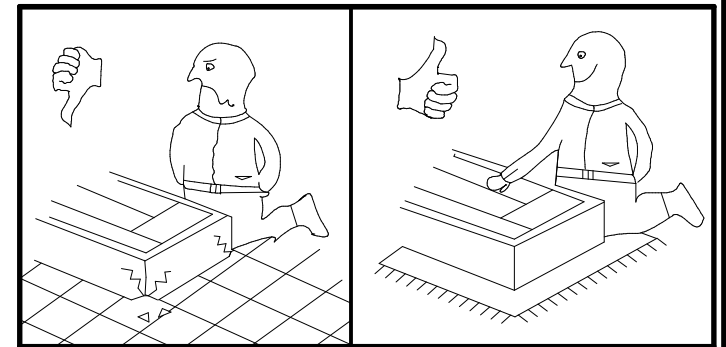
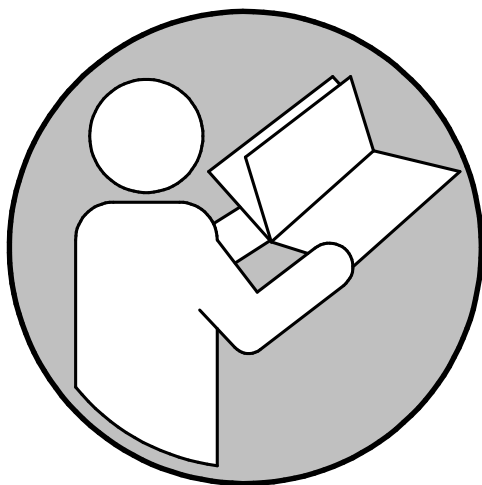
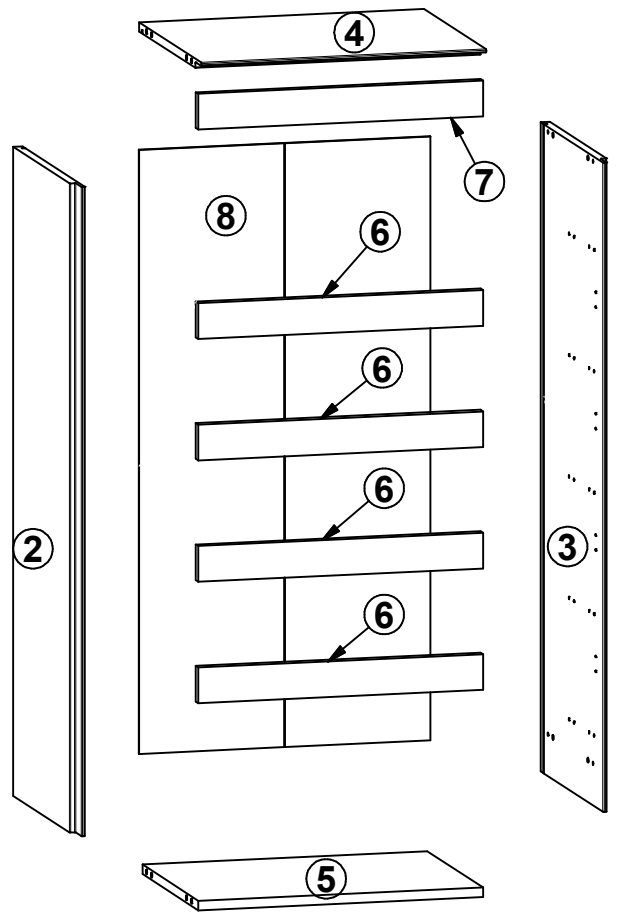
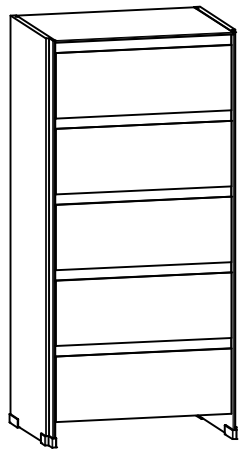
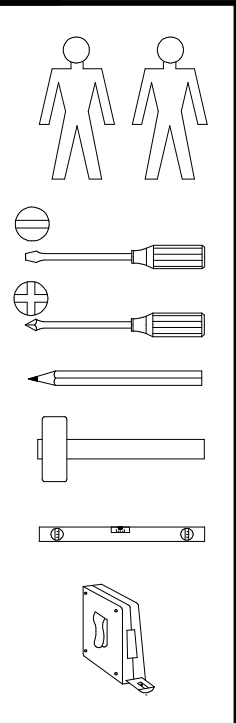
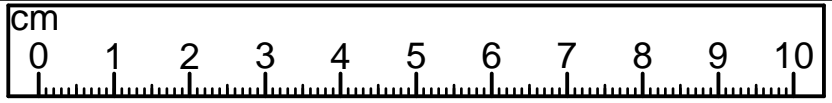
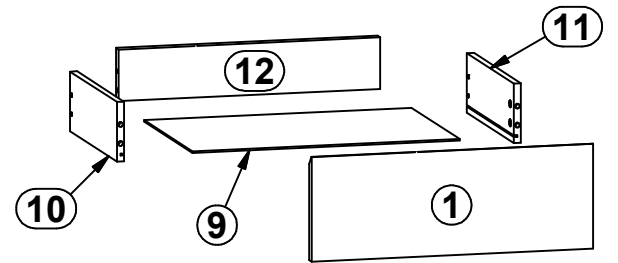

2x d36	8x d35\1	8x d35\2	40x Ø6x13 mm e3	8x Ø8x30 mm f1	20x Ø6.5x40 mm f25	1x k96\L	1x k96\P	2x k97	10x l1	9x l2	5x Ø3.5x16 mm p25	5x Ø3.5x10 mm p35
20x Ø3.5x16 mm p38	36x Ø3.5x15 mm p51	4x Ø3.5x16 mm p61	8x Ø15x12 mm #16 r1	20x Ø12x10.5 mm #12 r15	28x r42	5x 300 mm t25	5x 300 mm W125\L	5x 300 mm W125\P	1x n26\1	1x Ø3.5x16 mm p38		

1

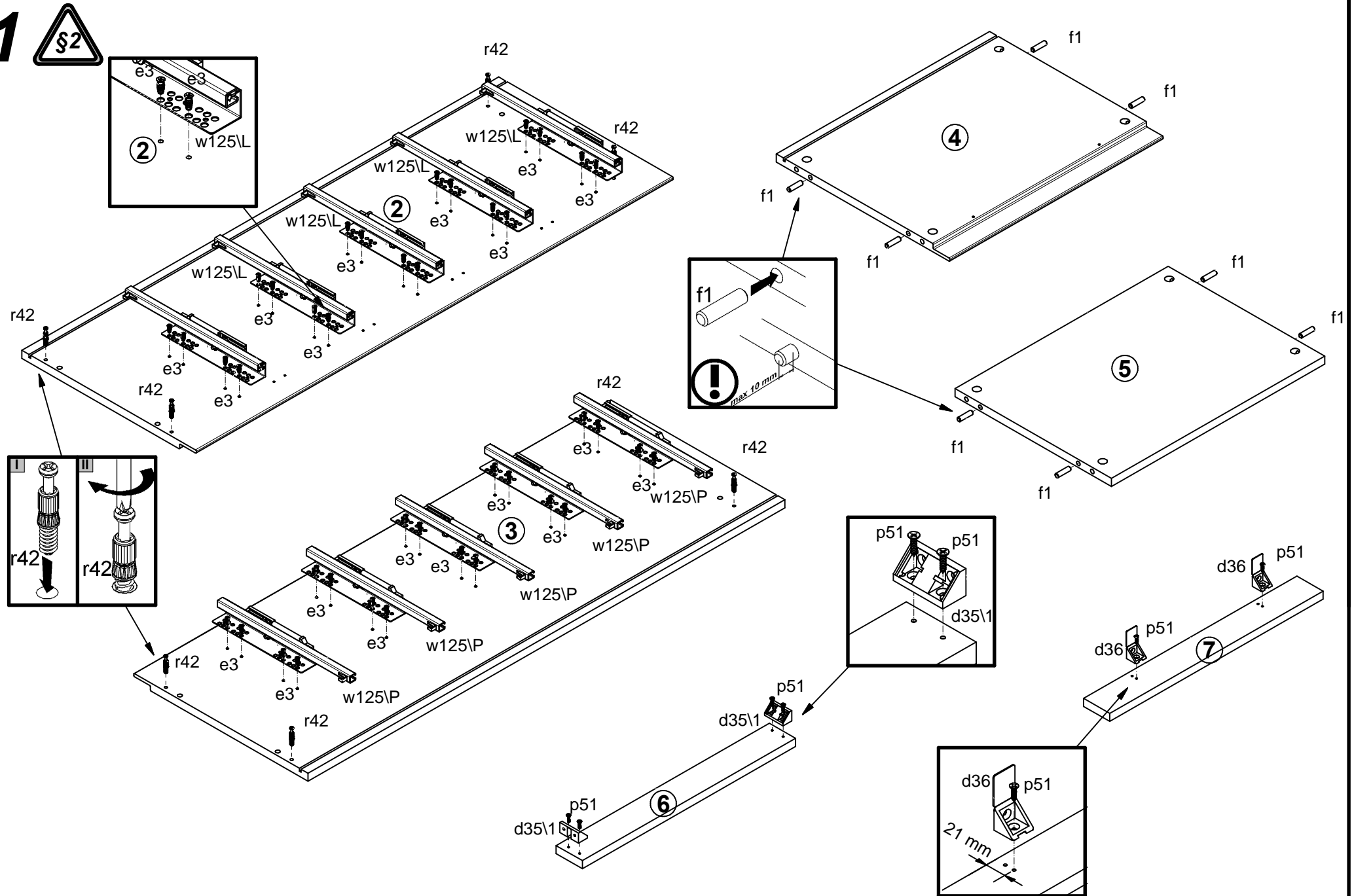



2

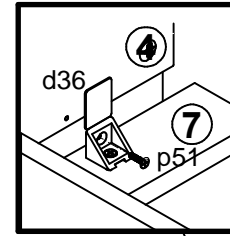
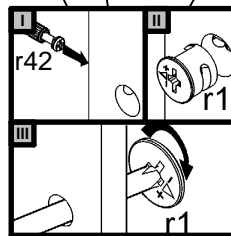
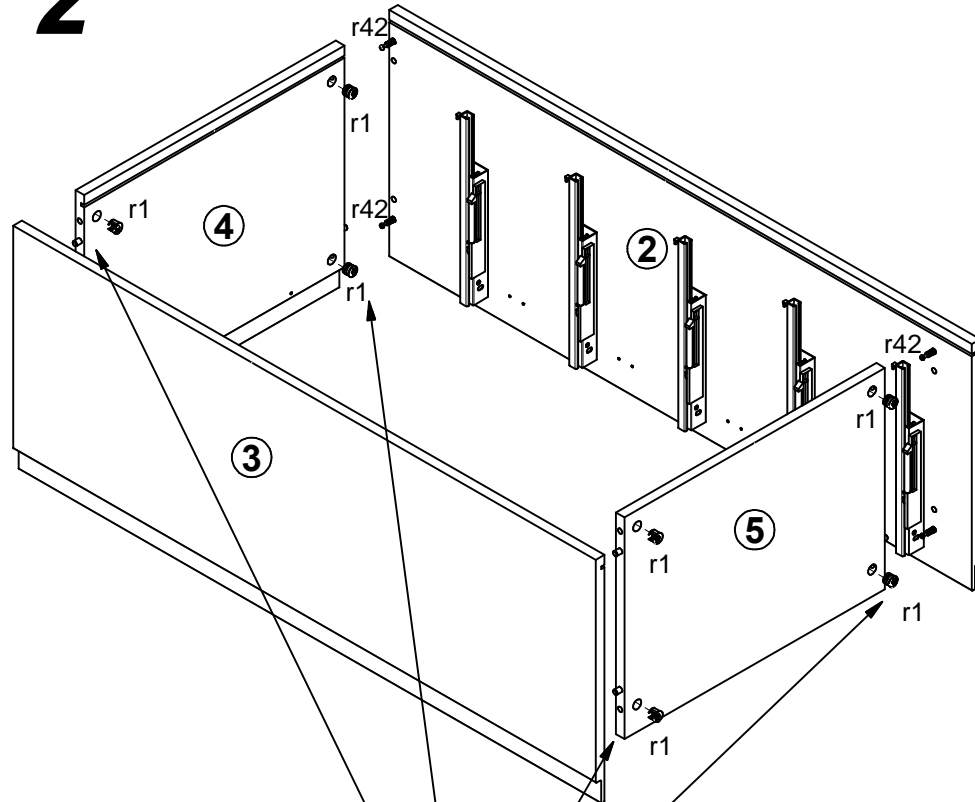

3

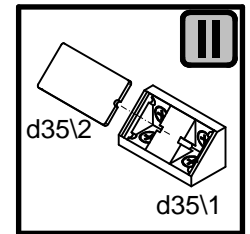
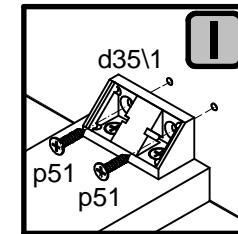
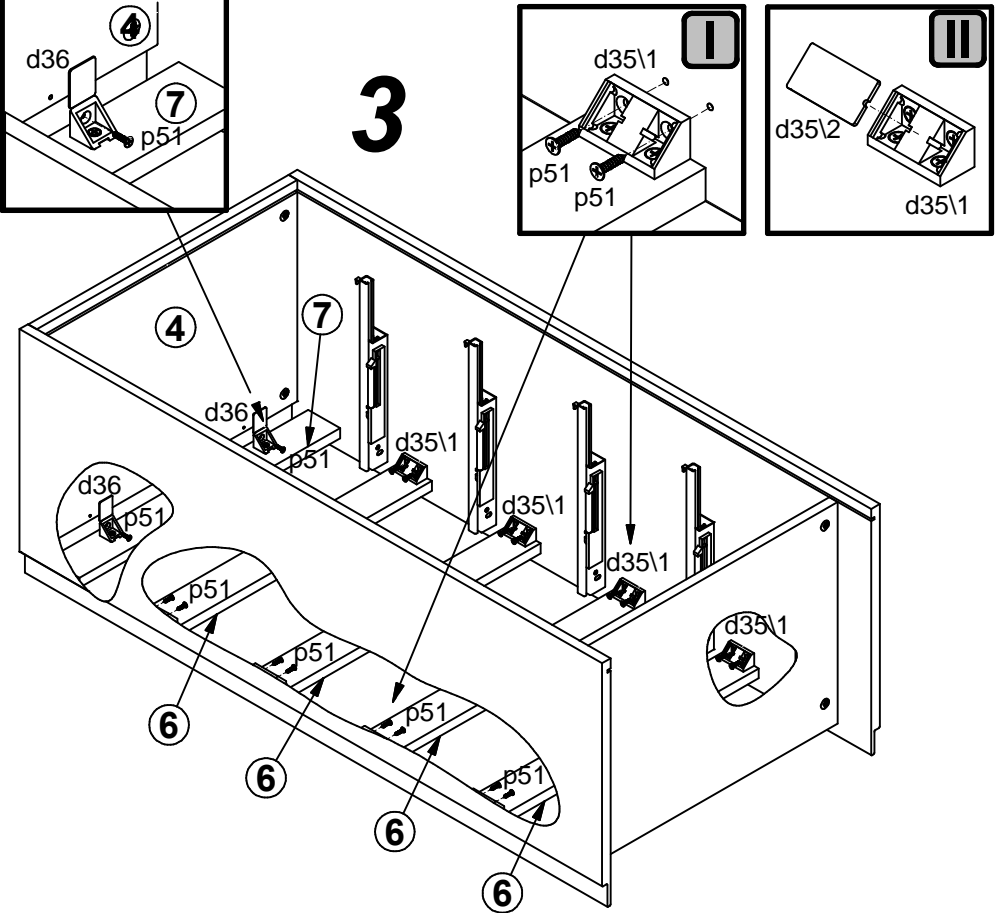

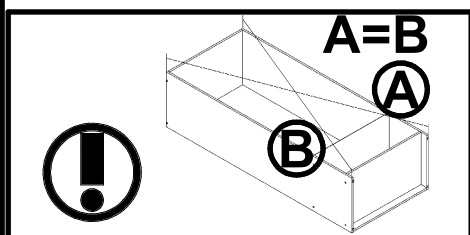
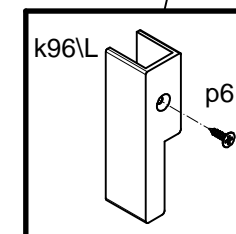
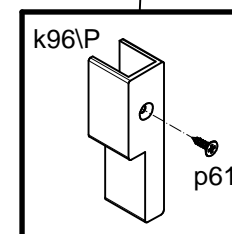
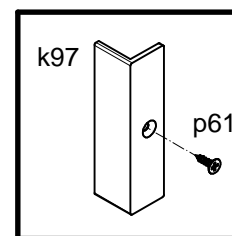
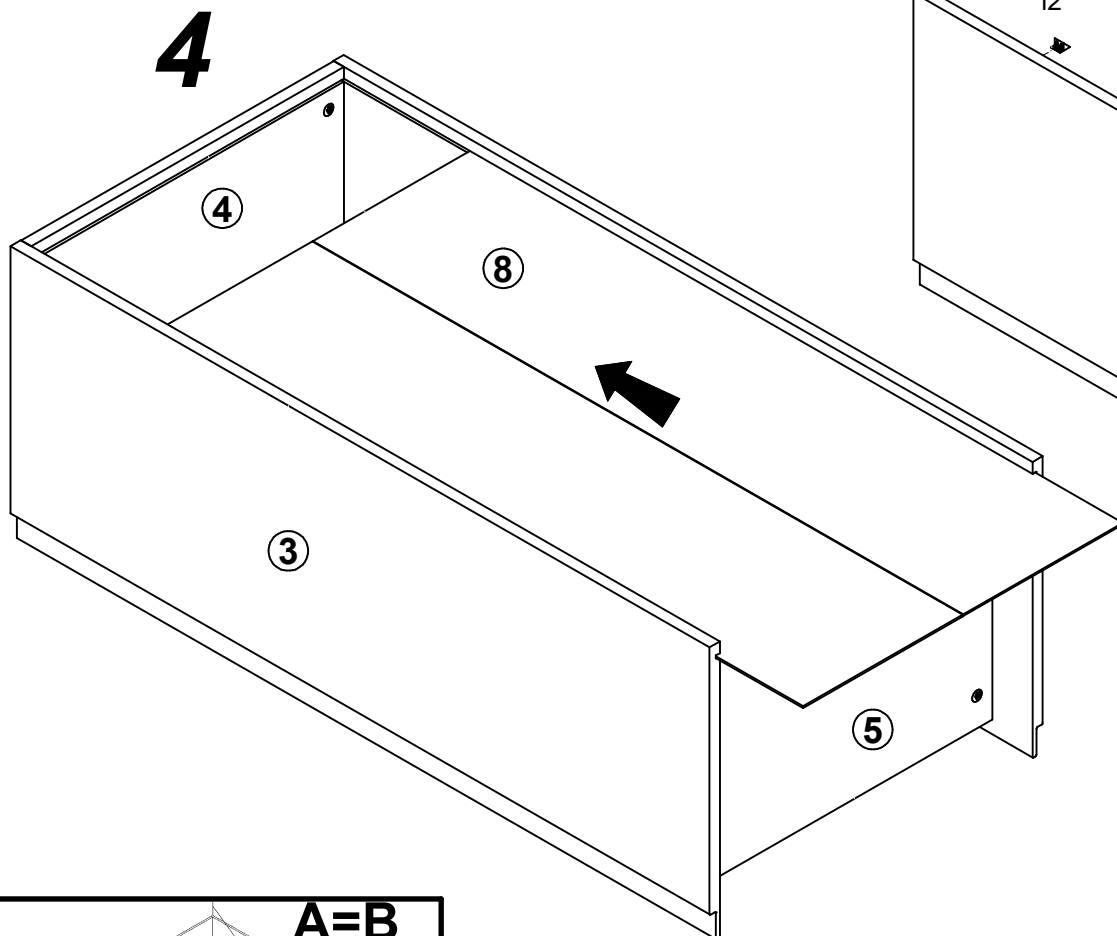
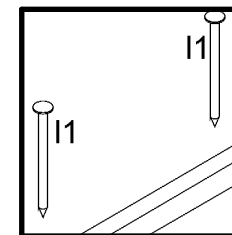
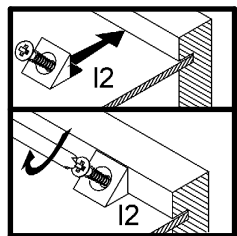

§2 6

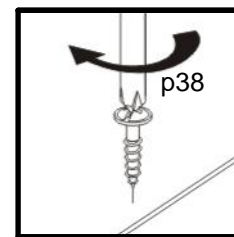
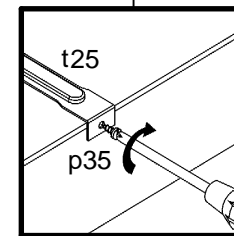
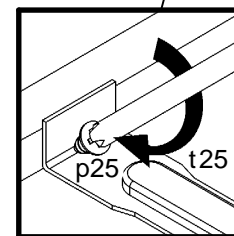
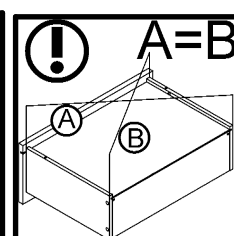
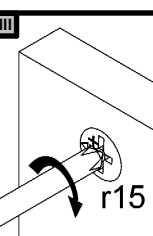
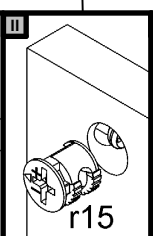
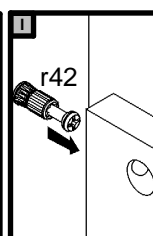
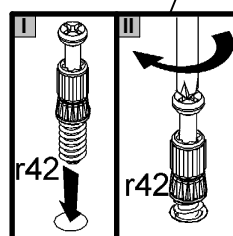
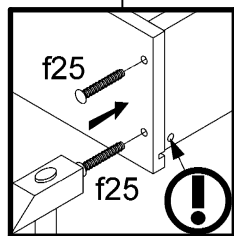
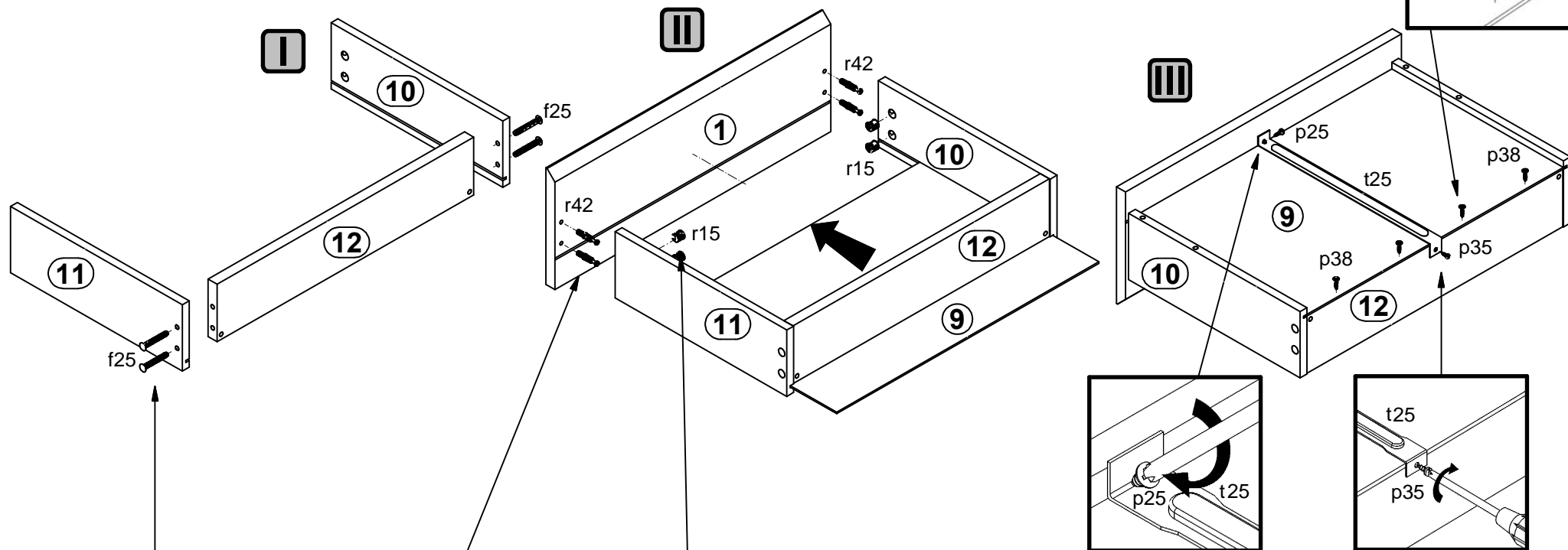

7

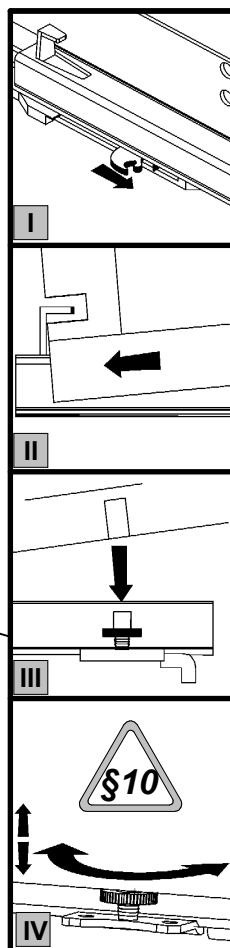
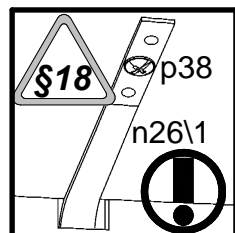
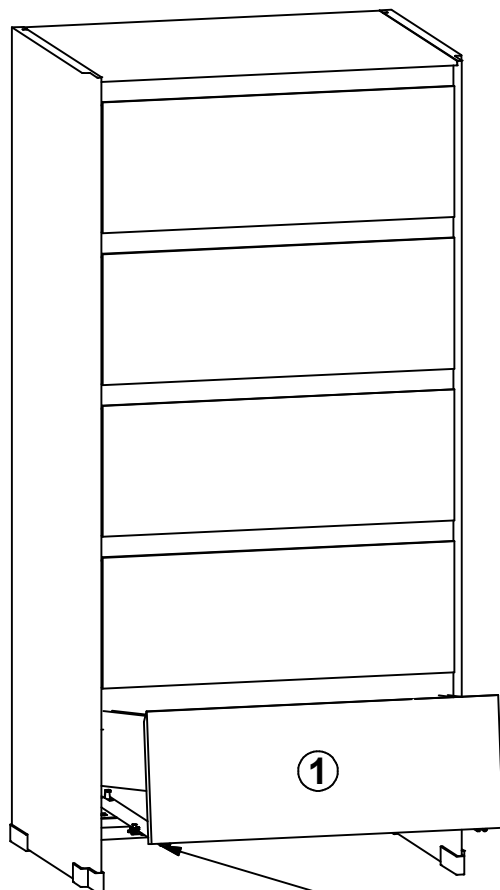
**Pflegehinweis!**

Bitte nur mit einem Staubtuch
(kein Microfasertuch) oder
einem feuchten Lappen reinigen.
KEINE scheuernden Putzmittel
verwenden!

Wskazówka dotycząca pielęgnacji!

Proszę czyścić tylko suchą lub lekko
wilgotną szmatką do kurzu. Nie używać
żadnych środków szorstkich!

