

A	B	C (mm)		D
1	S230-001	1934	396	2/2
2	S230-002	1934	396	2/2
3	S230-101	1922	540	1/2
4	S230-102	1922	540	1/2
5	S230-201	1001	562	1/2
6	S230-202	1001	562	1/2
7	S230-301	970	520	1/2
8	S230-571	1942	100	2/2
9	S230-9901	1932	981	1/2
10	dr-966	966	30	1/2

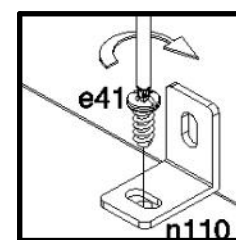

6x a132	4x a133	6x b43	6x Ø7x50 mm e1	12x Ø6.3x13 mm e2	8x Ø5x12 mm e41	18x Ø8x30 mm f1	4x k104	1x k27	10x l1	24x l2	2x n=22mm n1	4x 25x25x16/2 n110
2x Ø3.5x13 mm p1	8x Ø4x30 mm p21	12x Ø3.5x15 mm p51	14x Ø15x12 mm #16 r1	6x Ø15x15 mm #22 r3	20x r42	20x Ø16 s2	1x z1					
										1x n26/1	1x Ø3.5x16 mm p38	

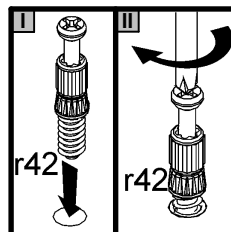
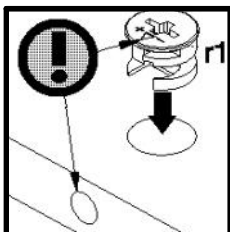
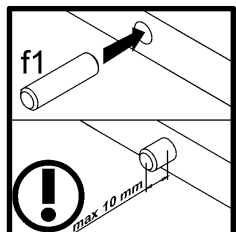
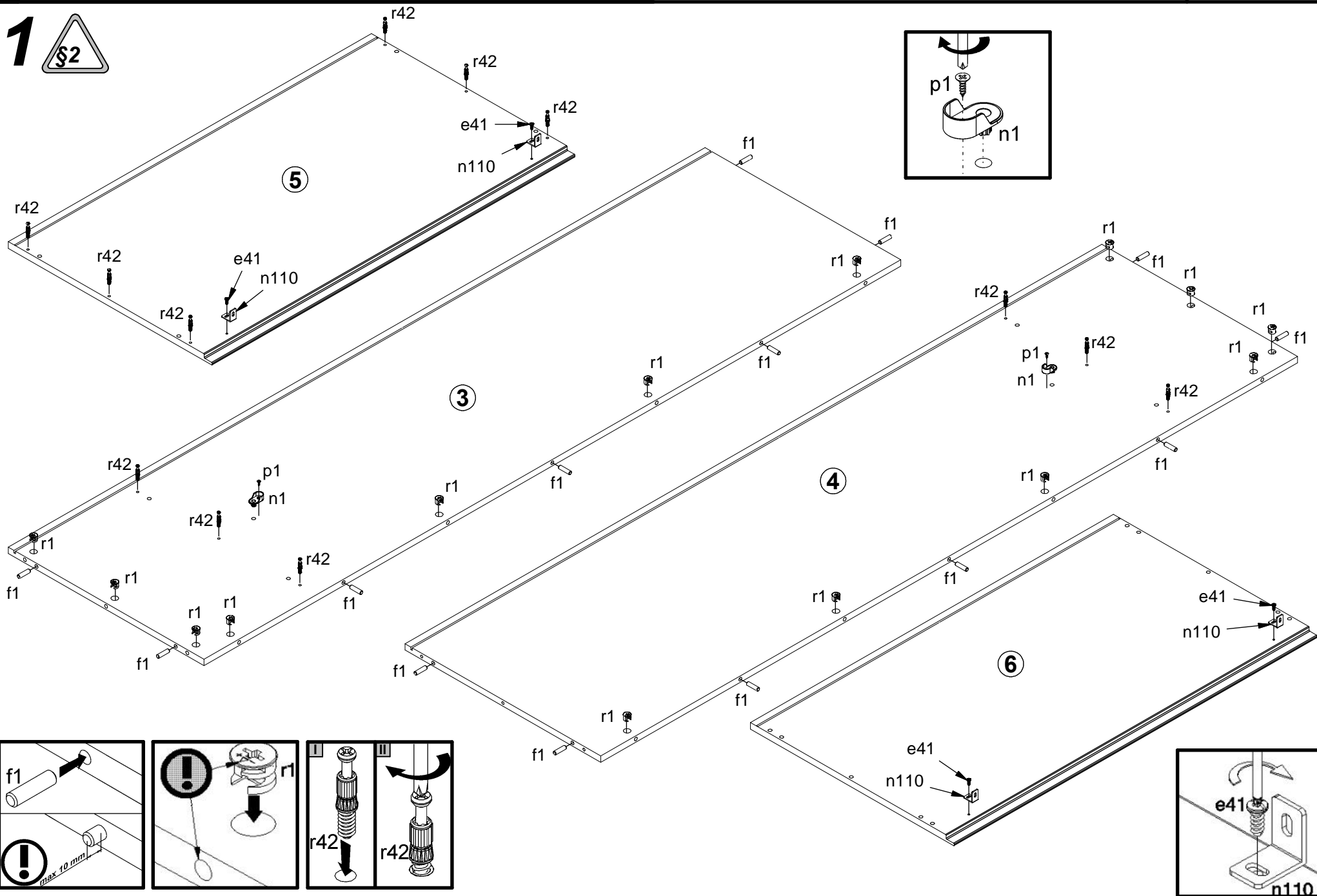

1

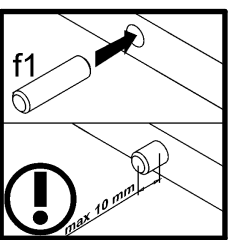
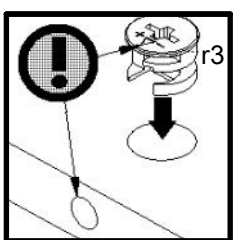
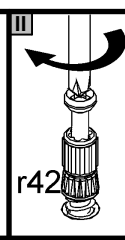
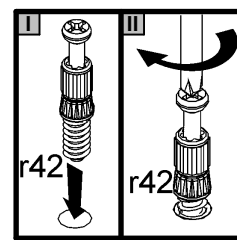
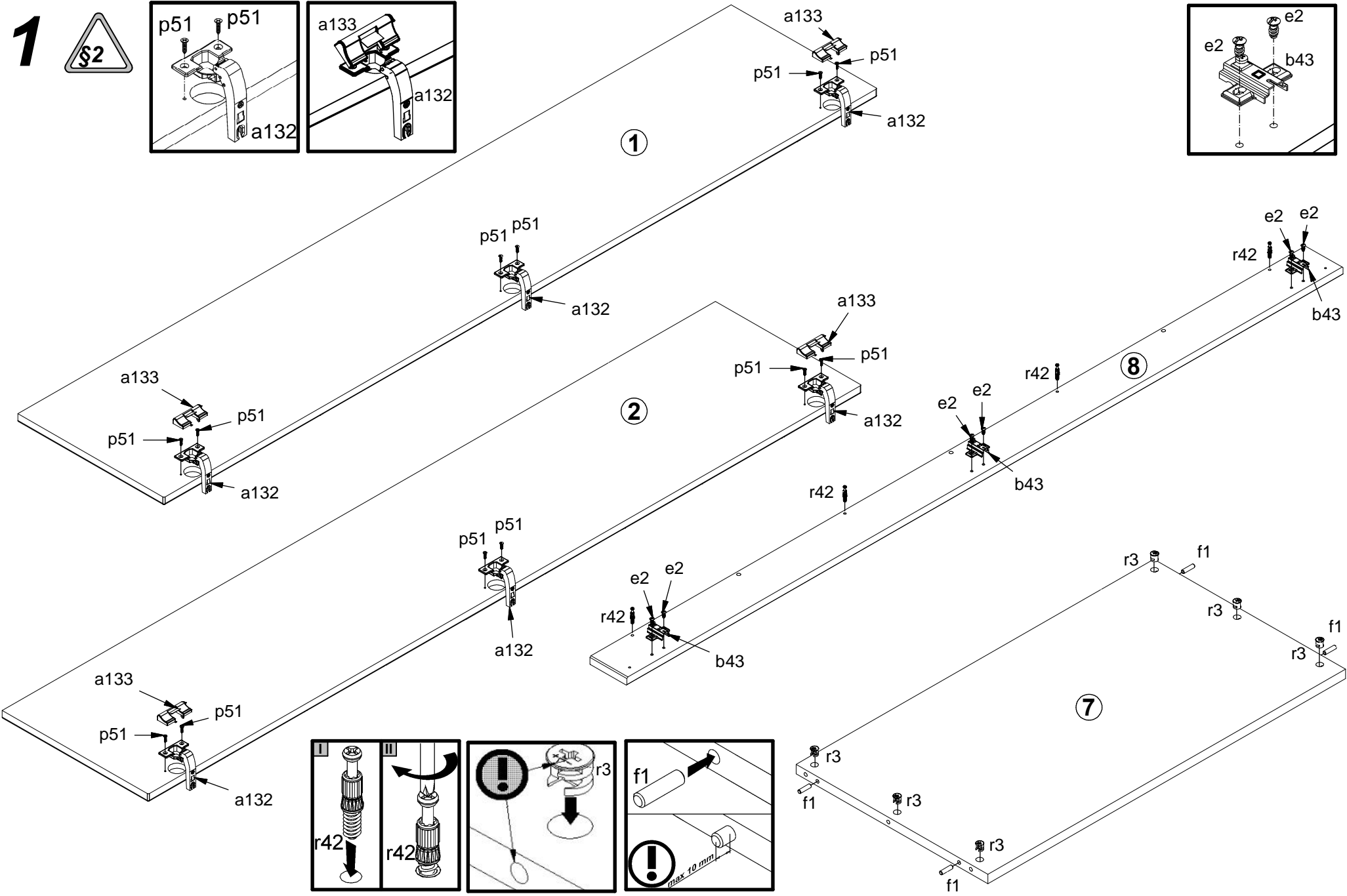
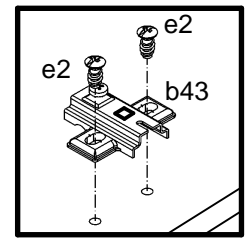
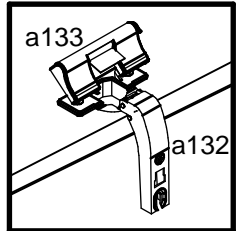
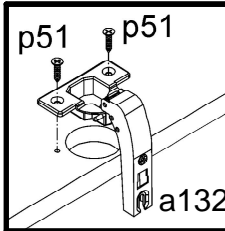

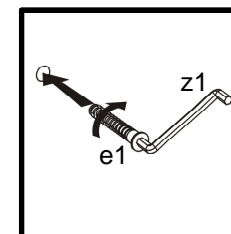
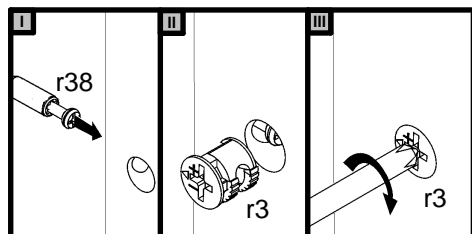
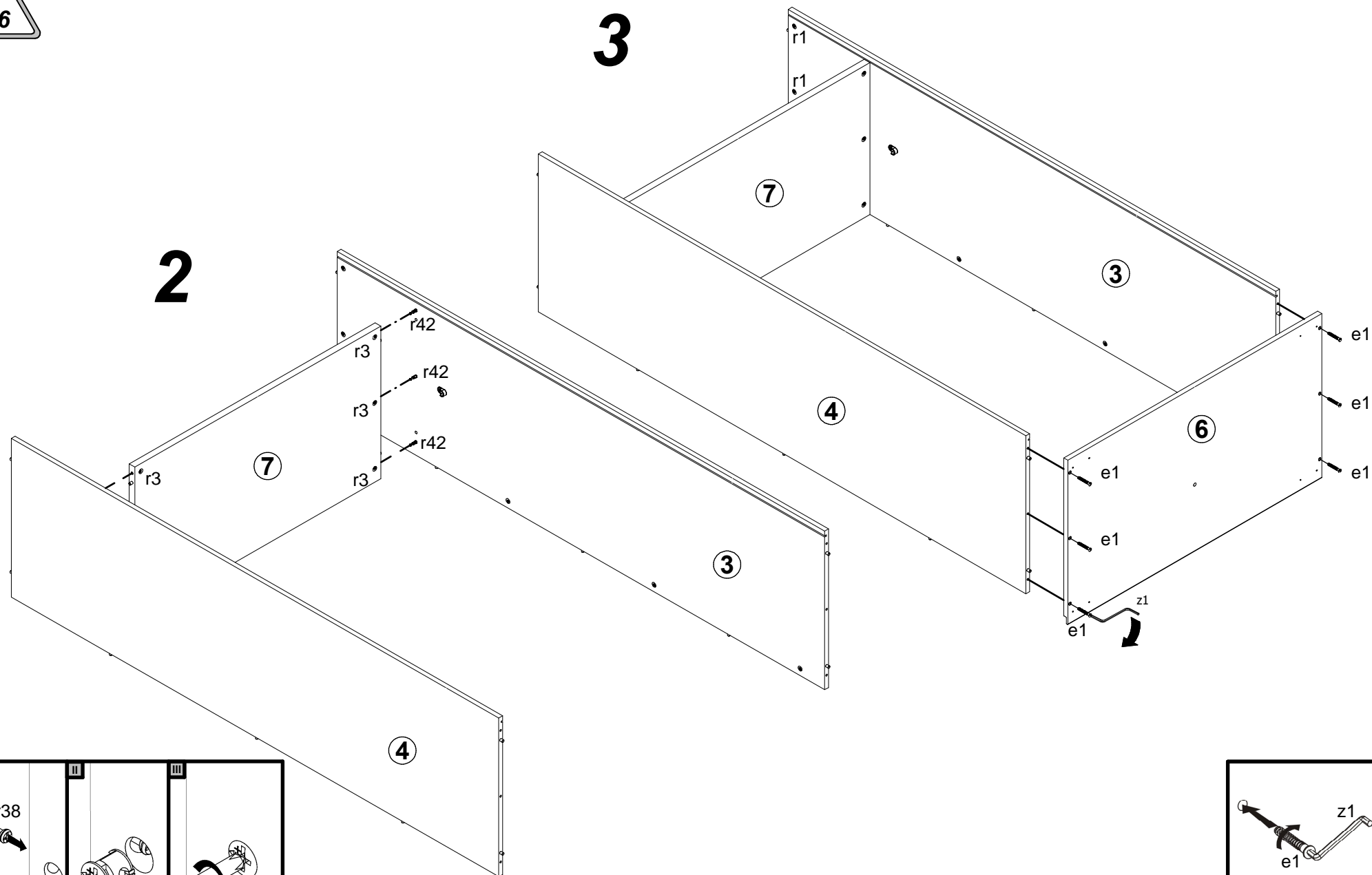

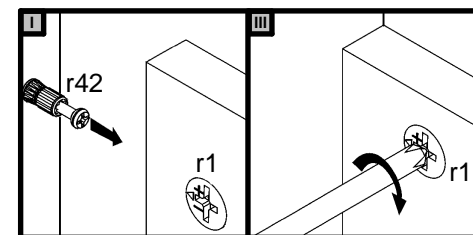
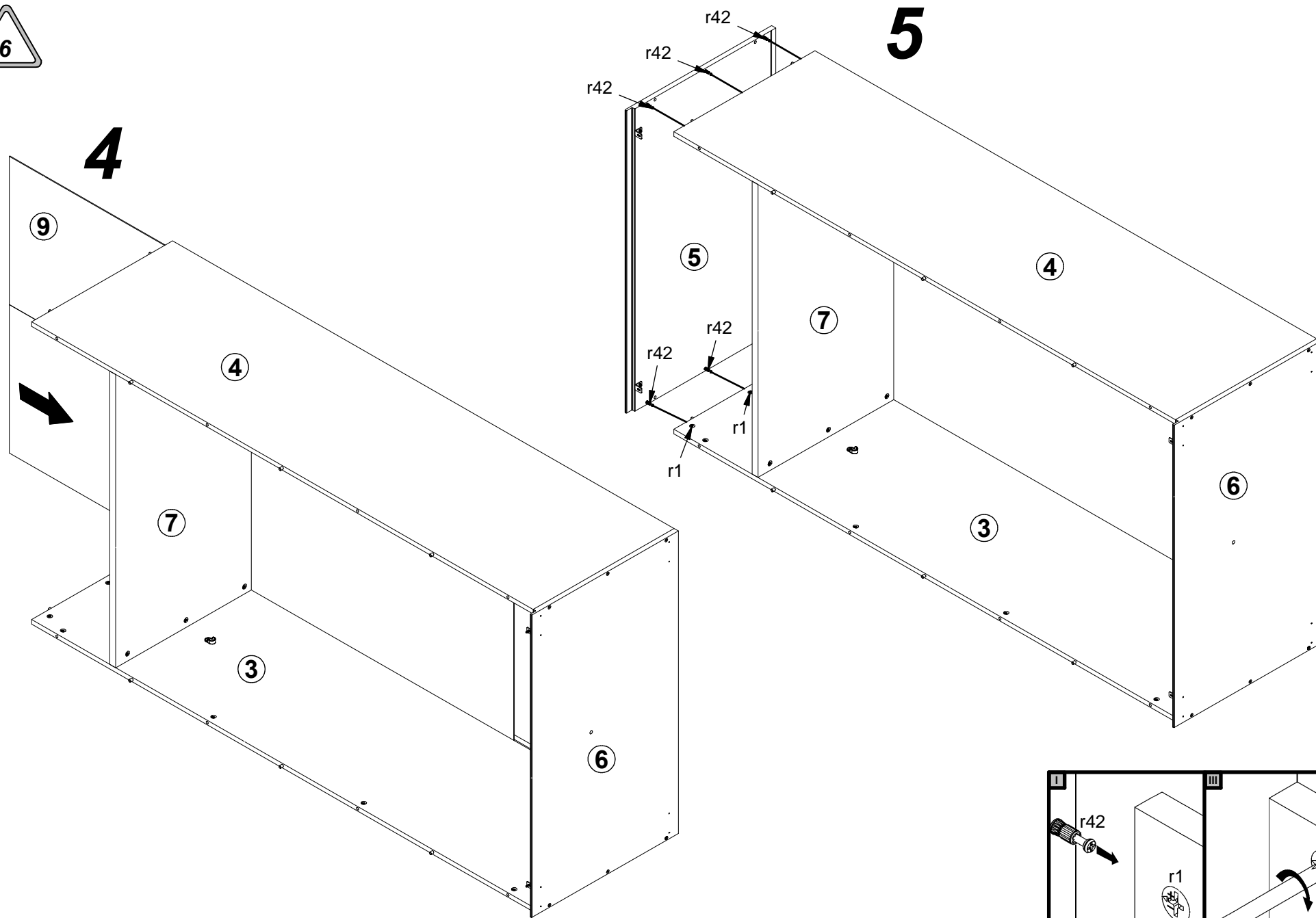

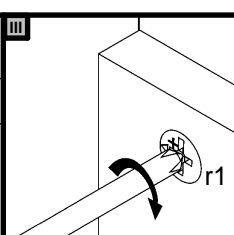
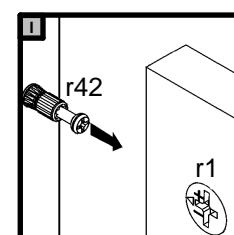
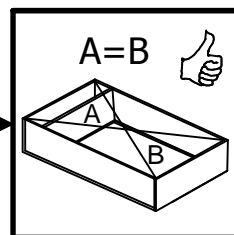
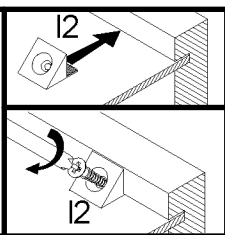
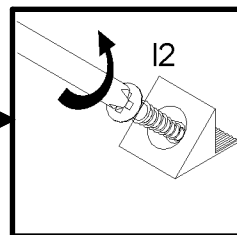
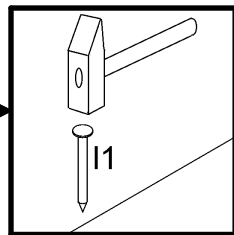
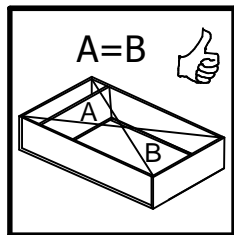

6

7

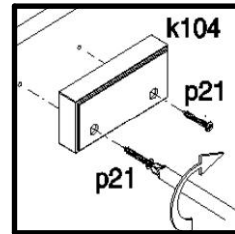
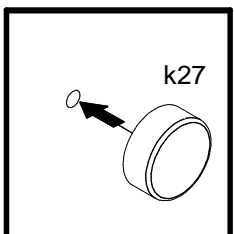
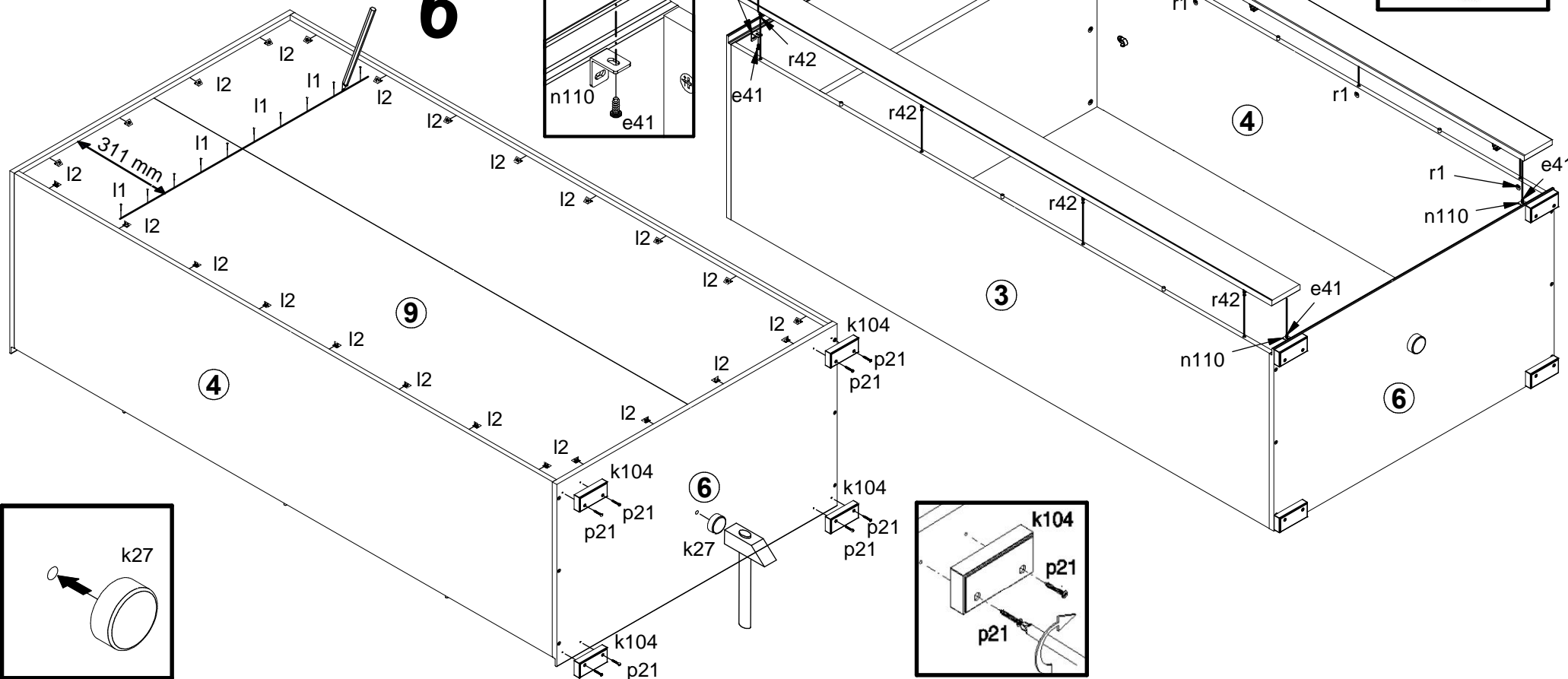
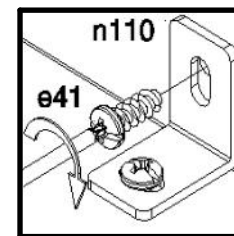
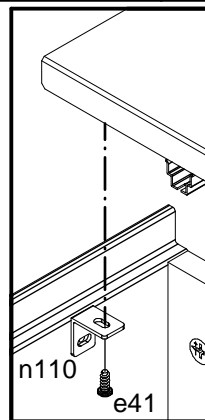

§6 8

