

A	B	C (mm)	D
1	S220-0001	2100	526
2	S220-1001	2048	540
3	S220-1002	2048	540
4	S220-1003	2048	520
5	S220-2001	1696	540
6	S220-2002	1696	540
7	S220-3001	559	520
8	S220-3002	1088	520
9	S220-3003	558	505
10	S220-5502	400	179
11	S220-7001	2100	596
12	S220-7004	100	336
13	S220-9301	2058	573
14	S220-9302	2058	1099
15	dr-1085	1085	30

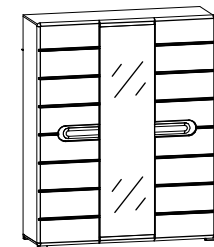

8x K16 a43	4x K9,5 a68	12x 03 b35	12x d1 Ø5x17 mm	9x e1 Ø7x50 mm	16x f1 Ø8x30 mm	2x f6 Ø8x50 mm	2x k53	4x k77 84x40/25 mm	17x l1	28x l2	2x n=22mm n1	14x n108 20x13x3,5/1
16x o54 Ø5,3/Ø8,3x4,8 mm	2x p1 Ø3,5x13 mm	10x p36 Ø4x25 mm	18x p38 Ø3,5x16 mm	24x p51 Ø3,5x15 mm	14x p55 Ø2,9x16 mm	15x r1 Ø15x12 mm #16	6x r3 Ø15x15 mm #22	3x r28 36/20 mm	15x r42	21x s2 Ø16	1x z1	2x n26/1

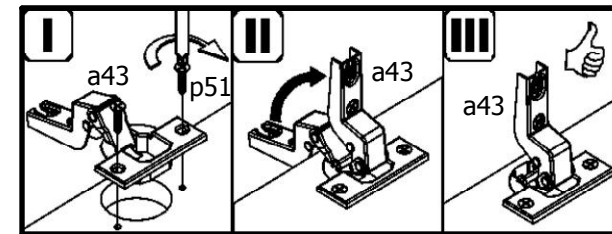
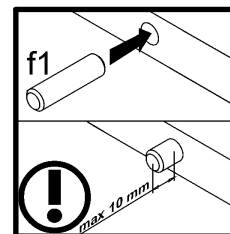
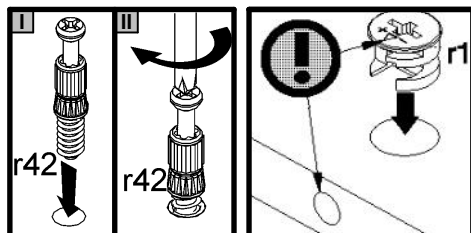
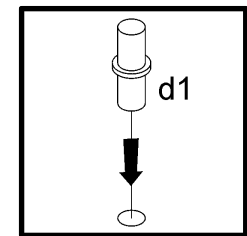
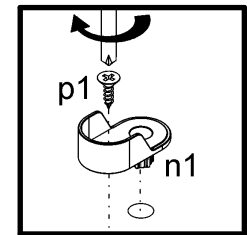
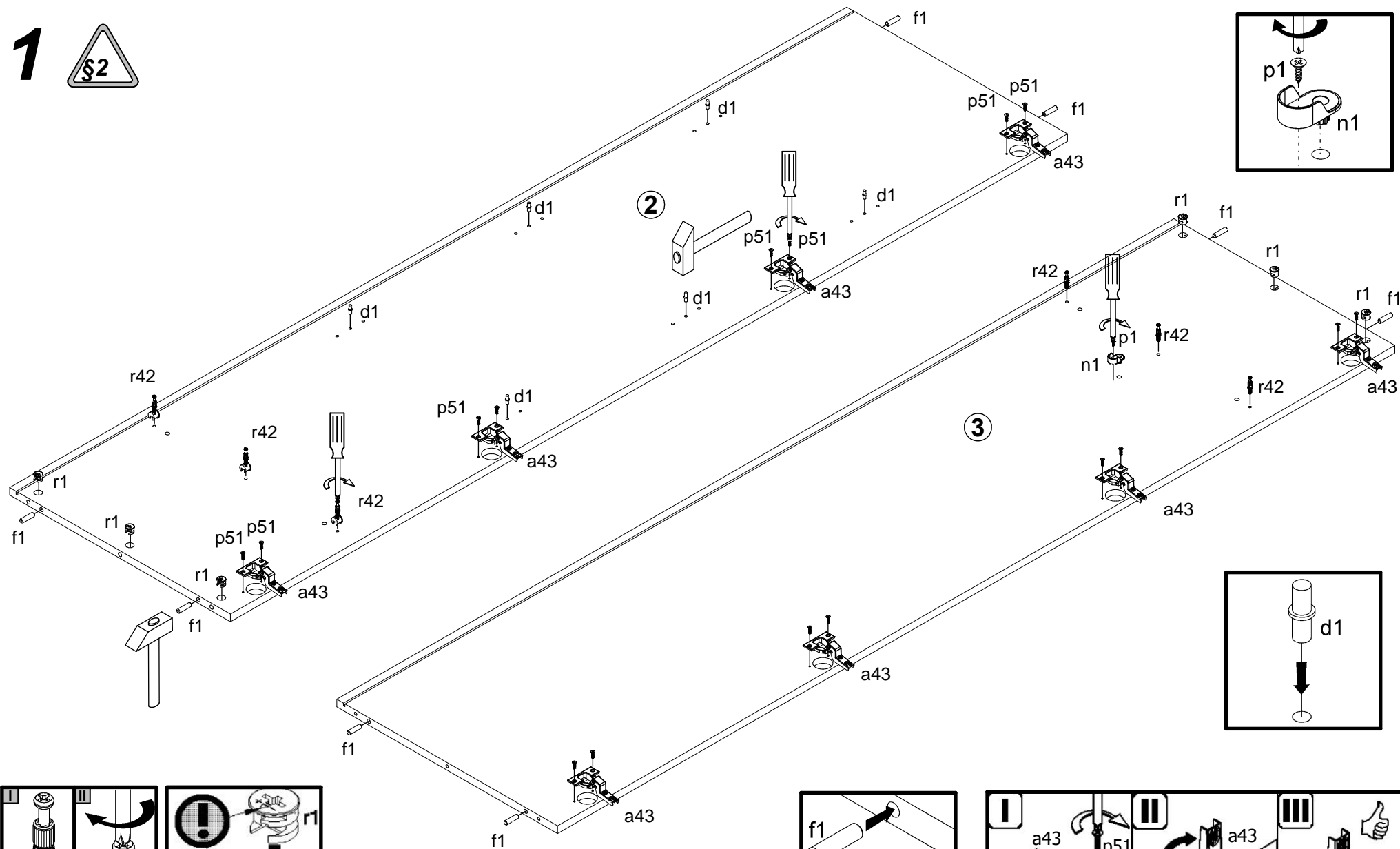

1 

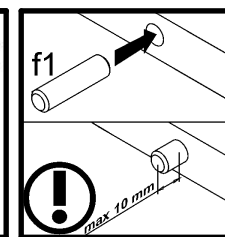
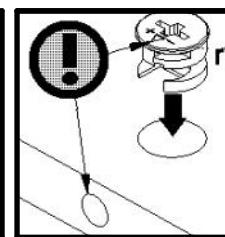
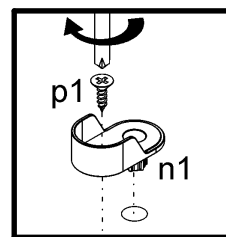
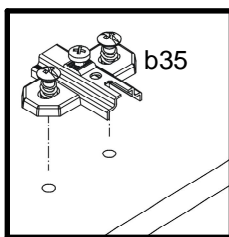
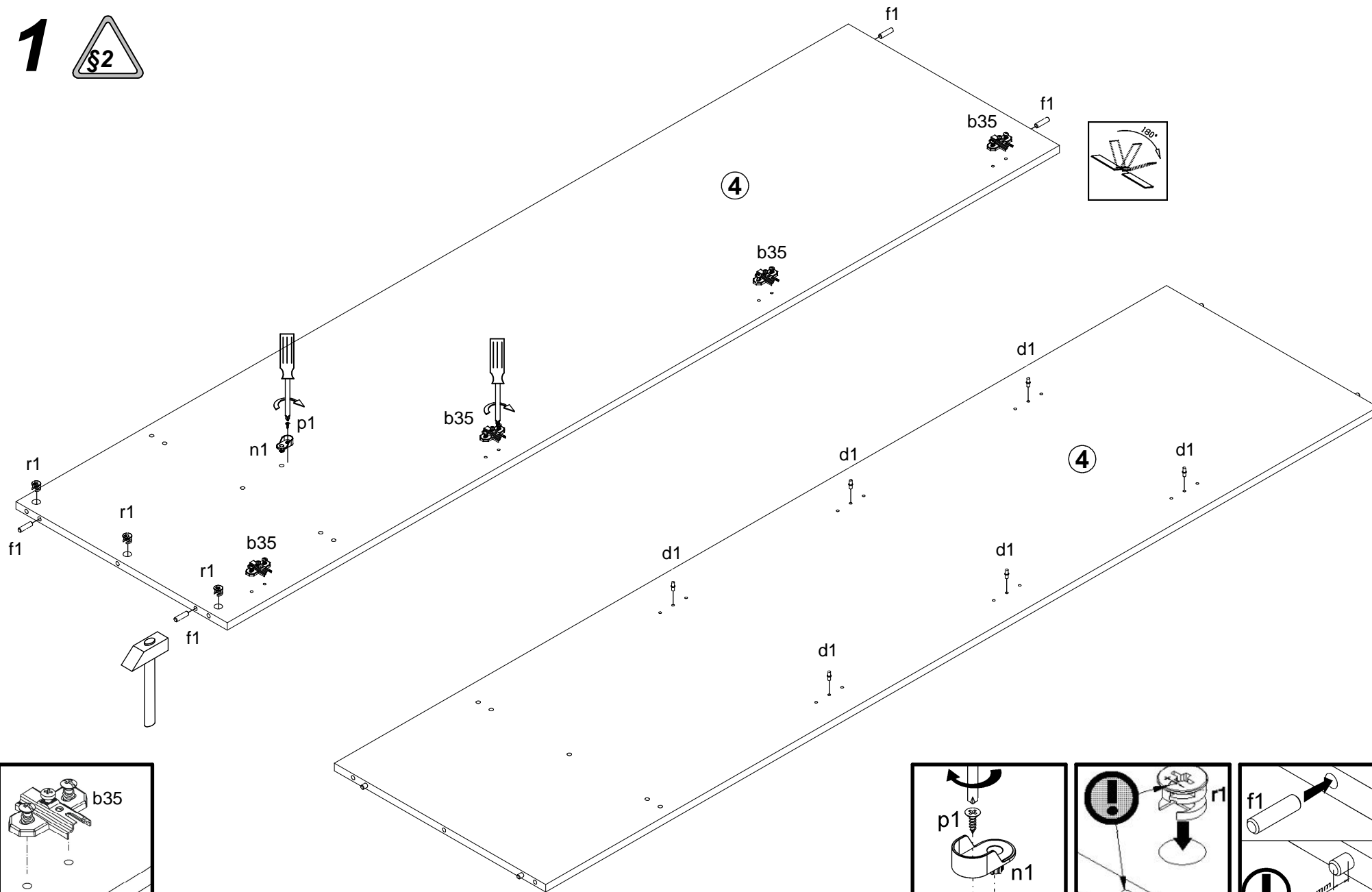

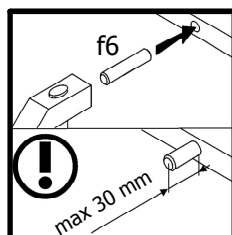
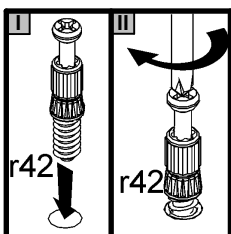
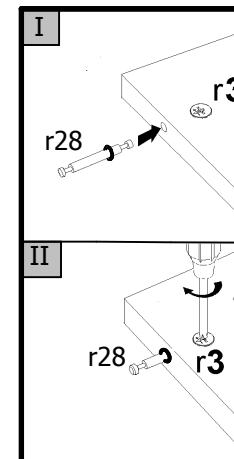
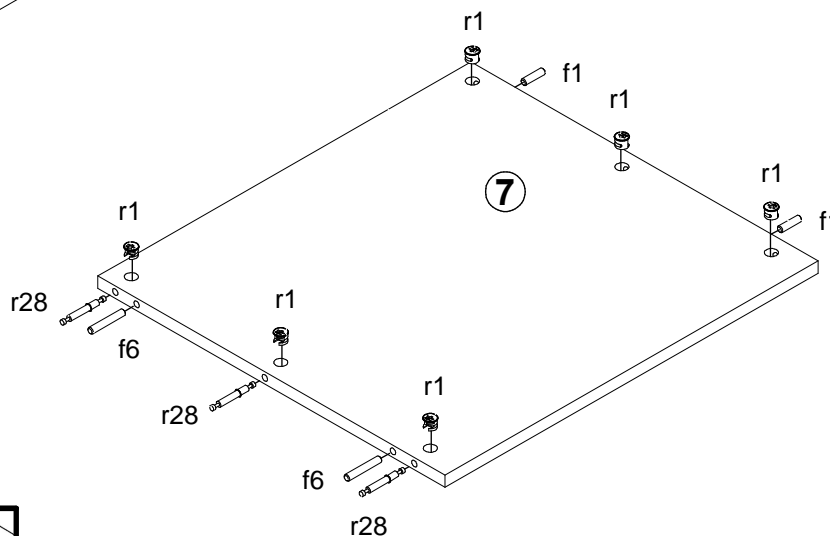
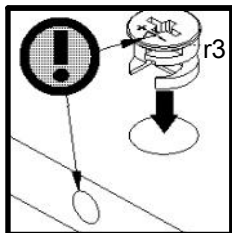
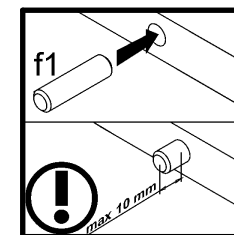
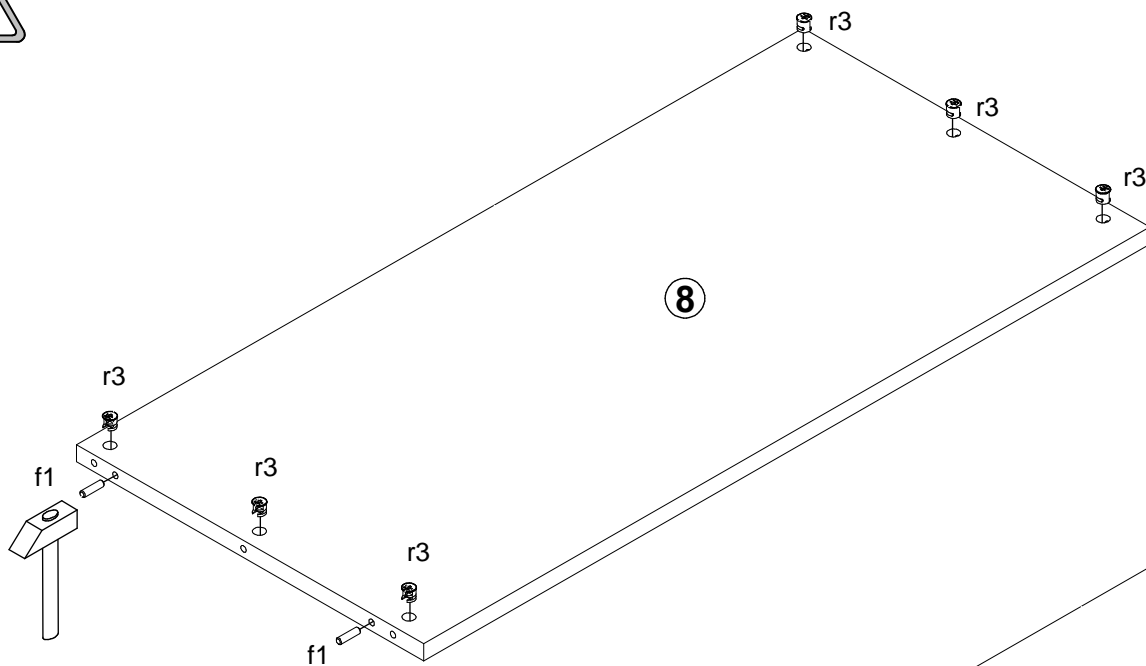

1

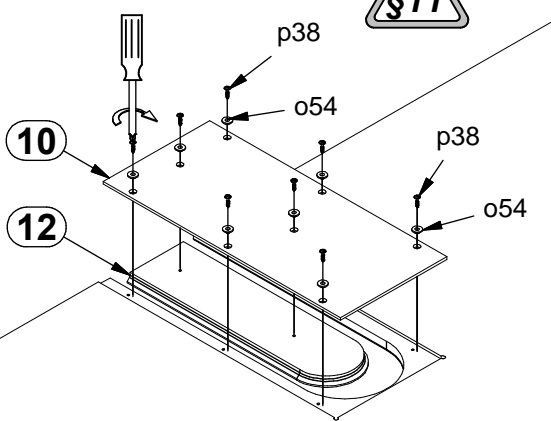
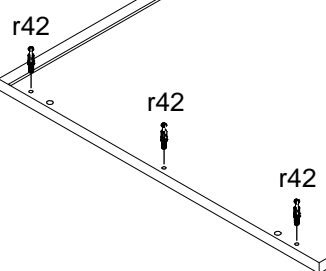
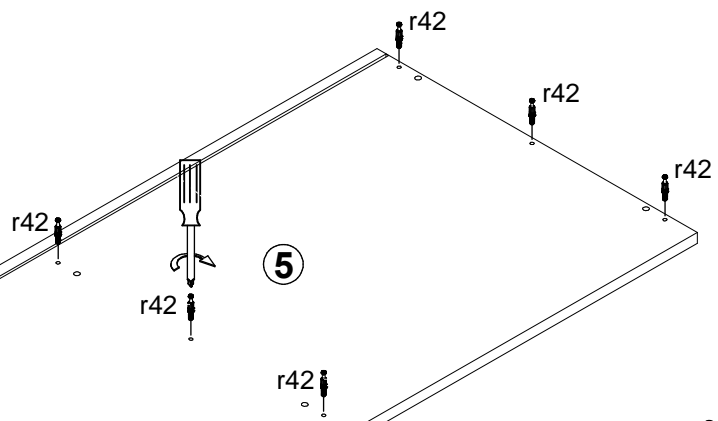
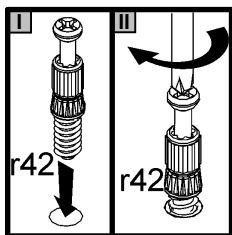

11

b35

b35

b35

b35

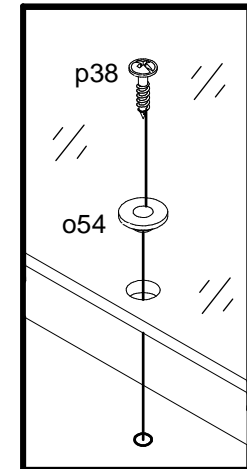
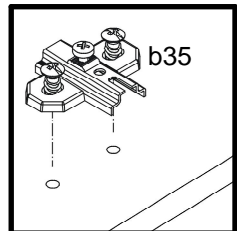

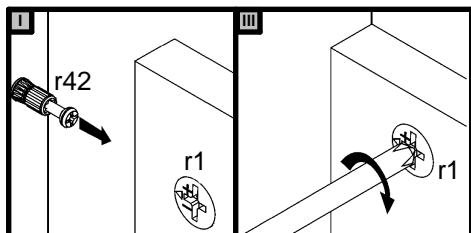
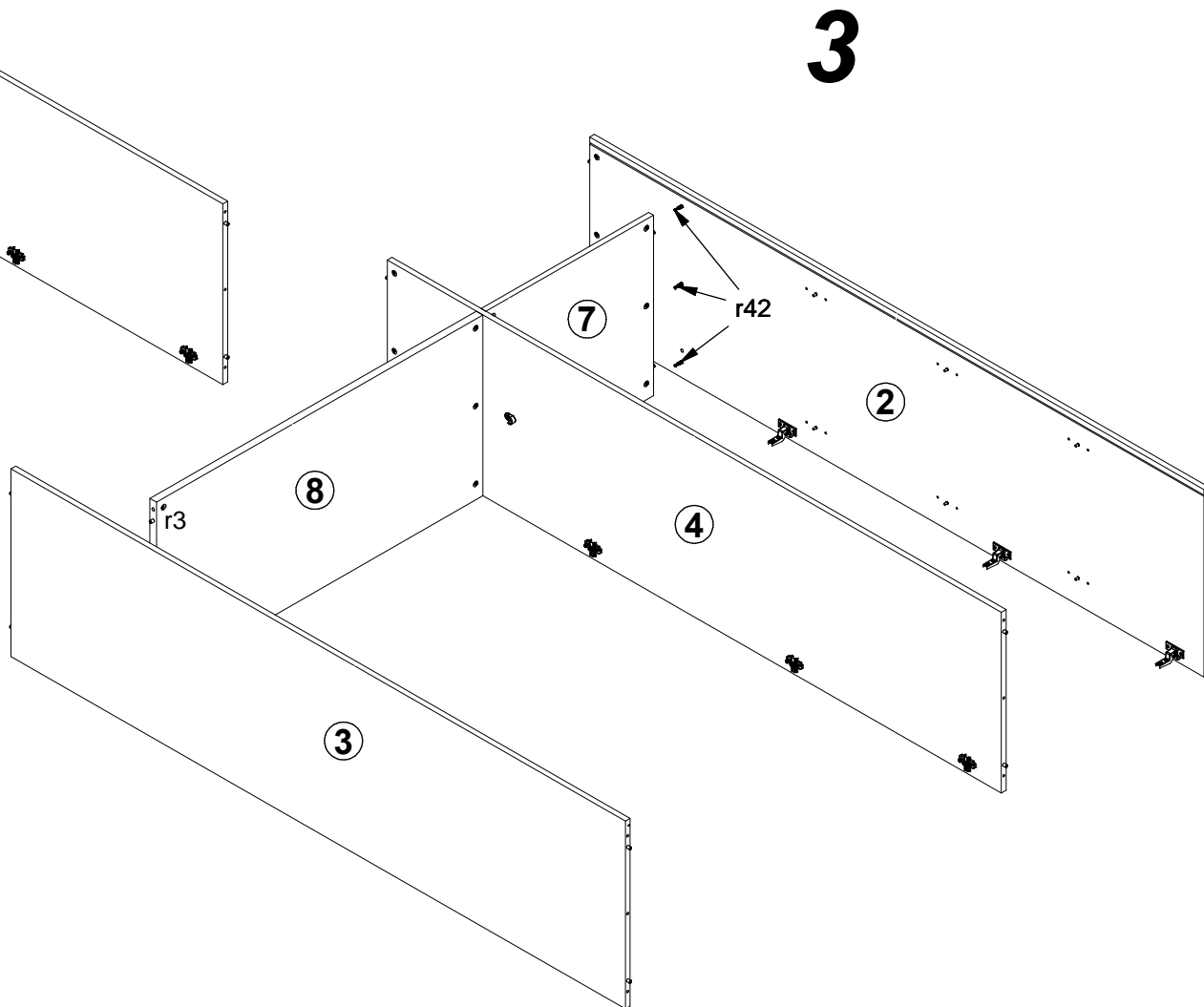
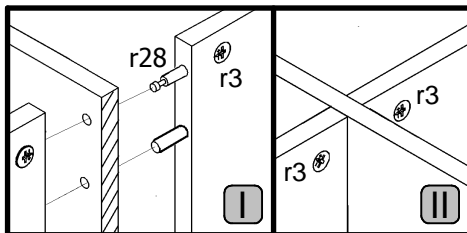
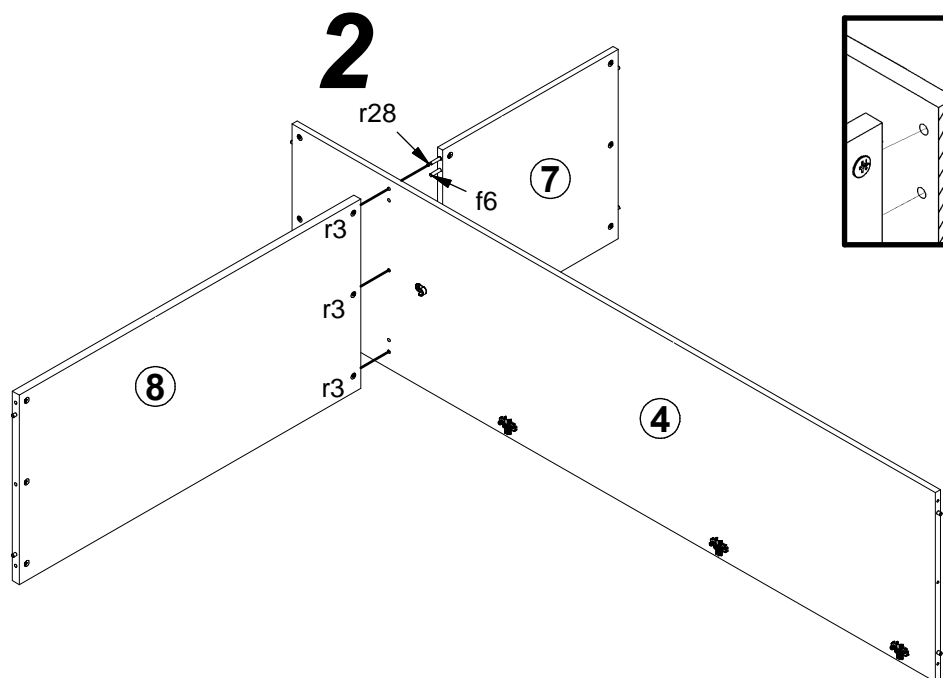

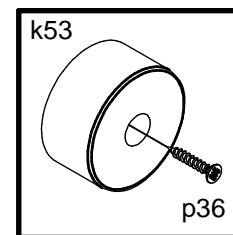
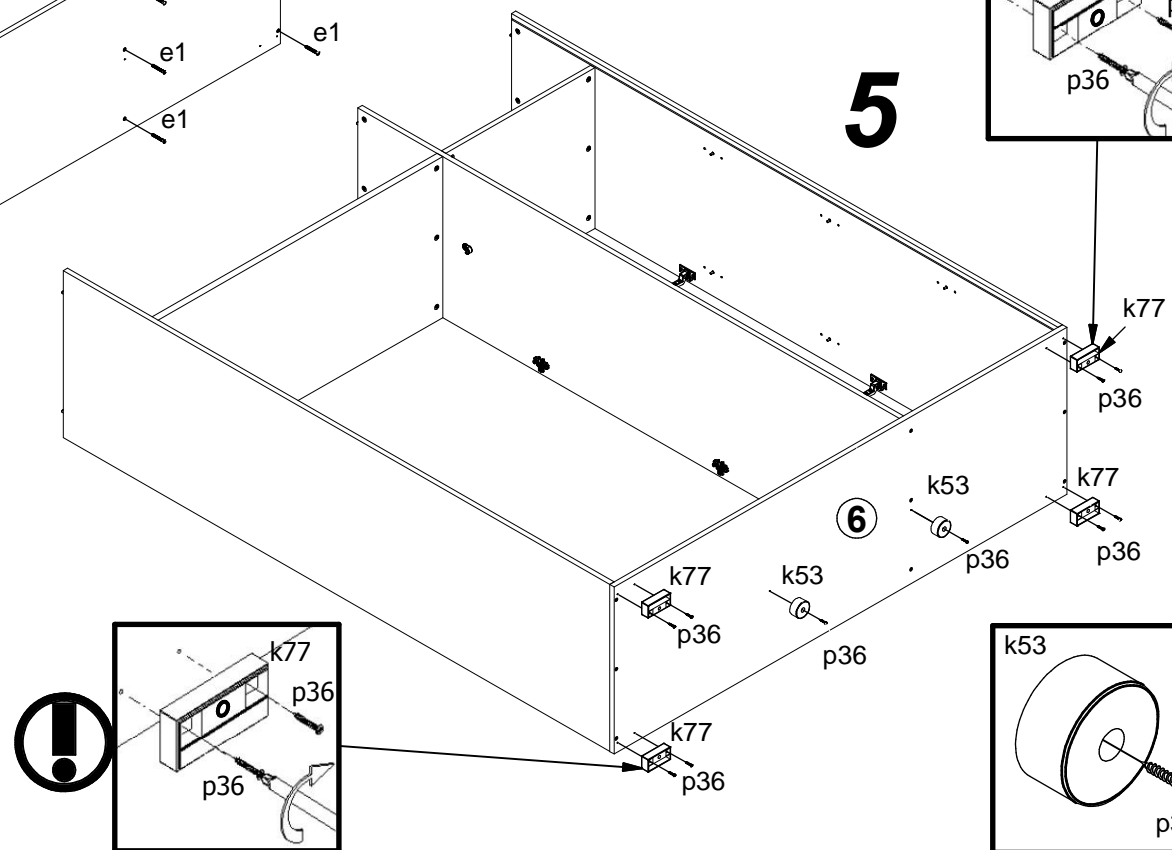
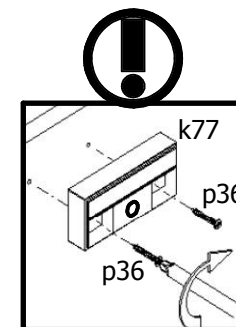
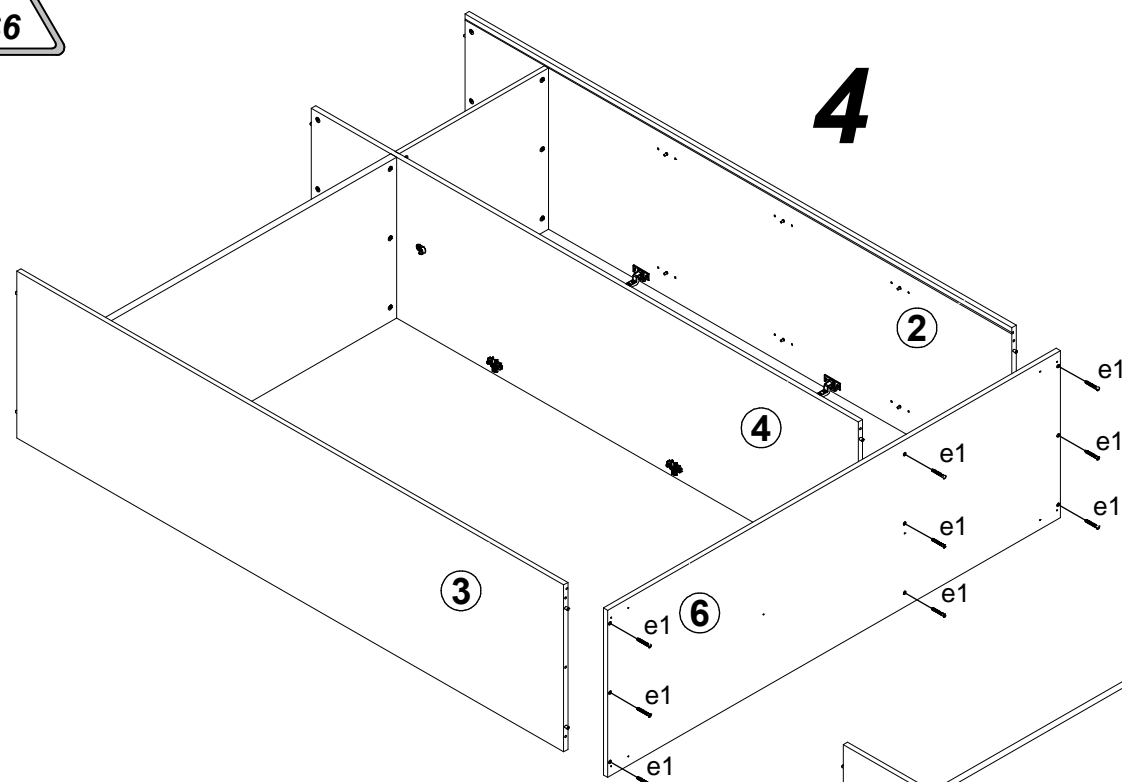
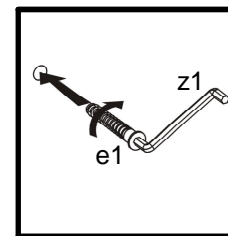



6

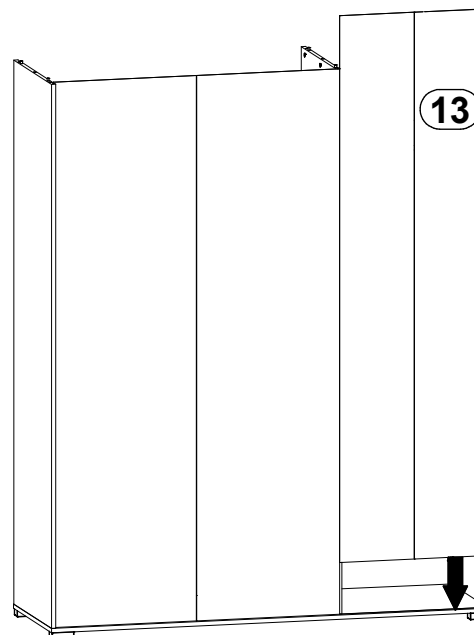
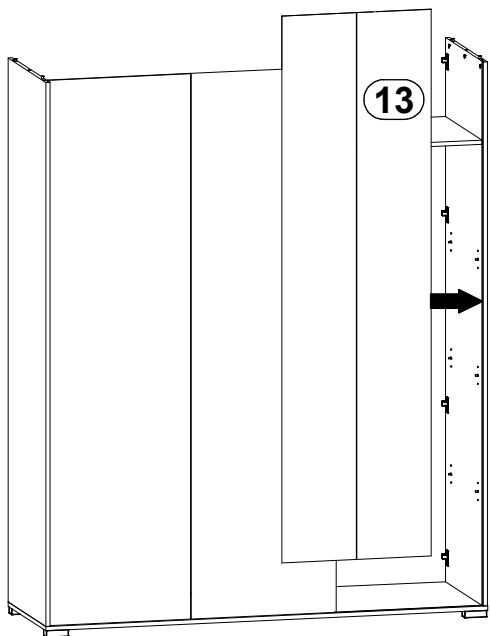
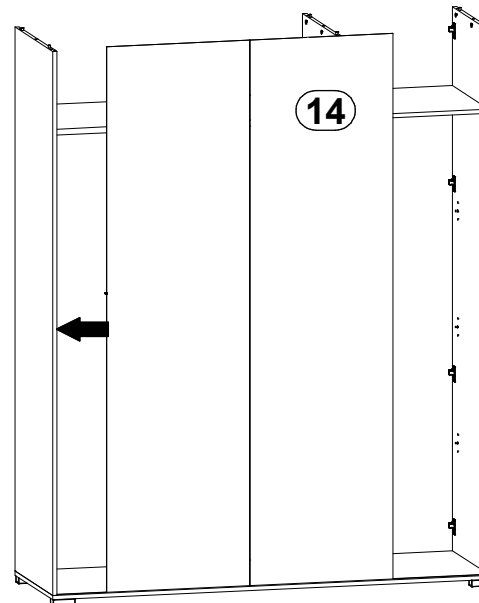
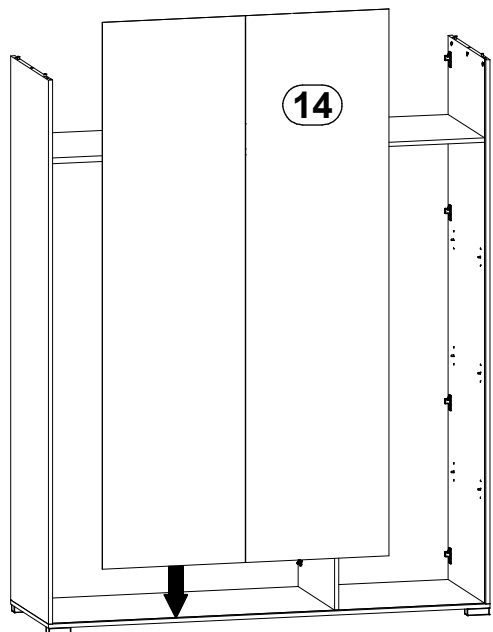



7

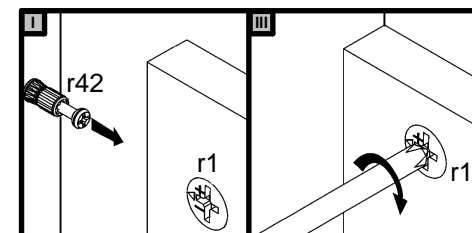
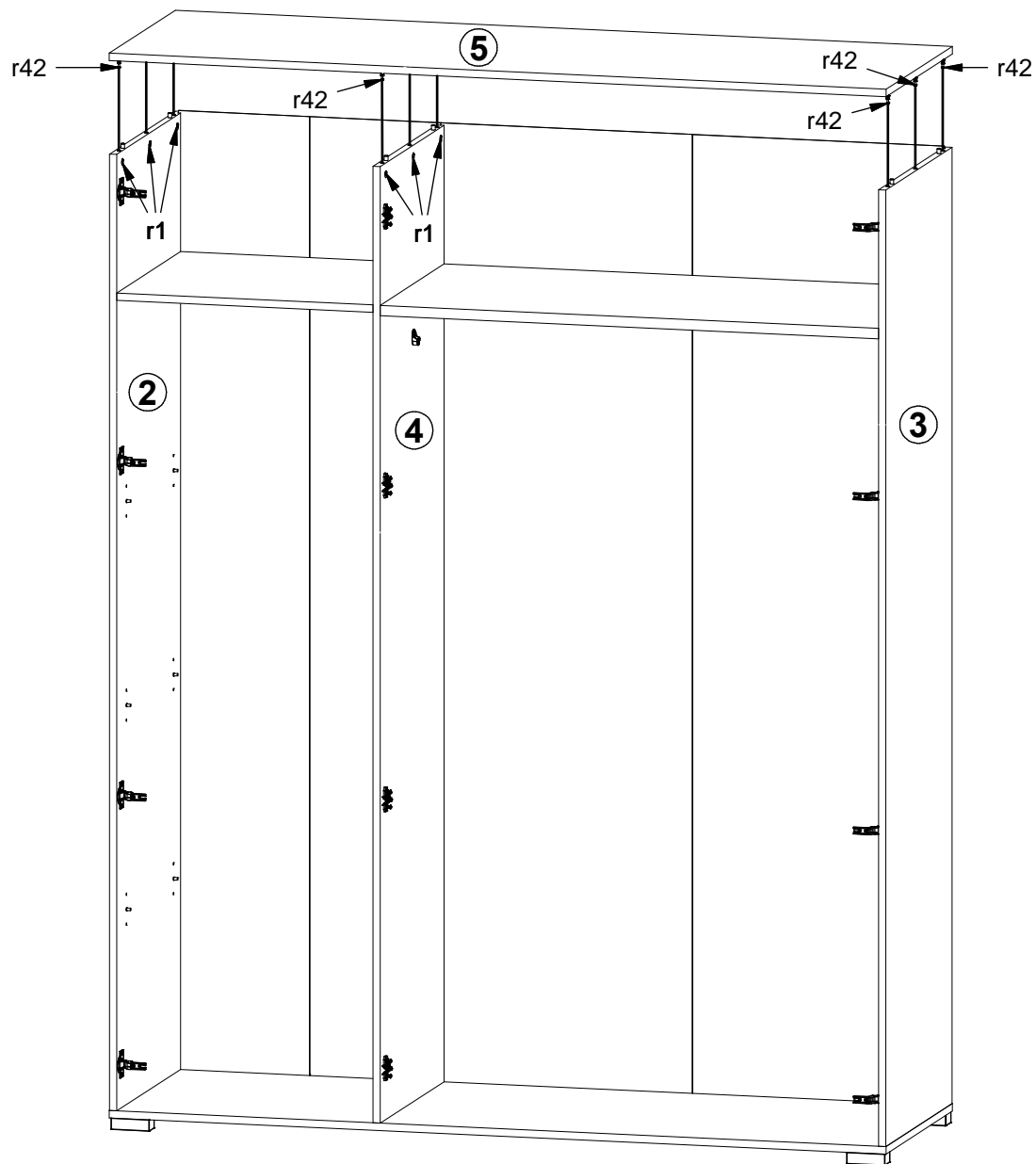

8

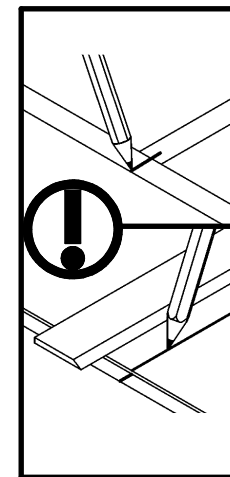
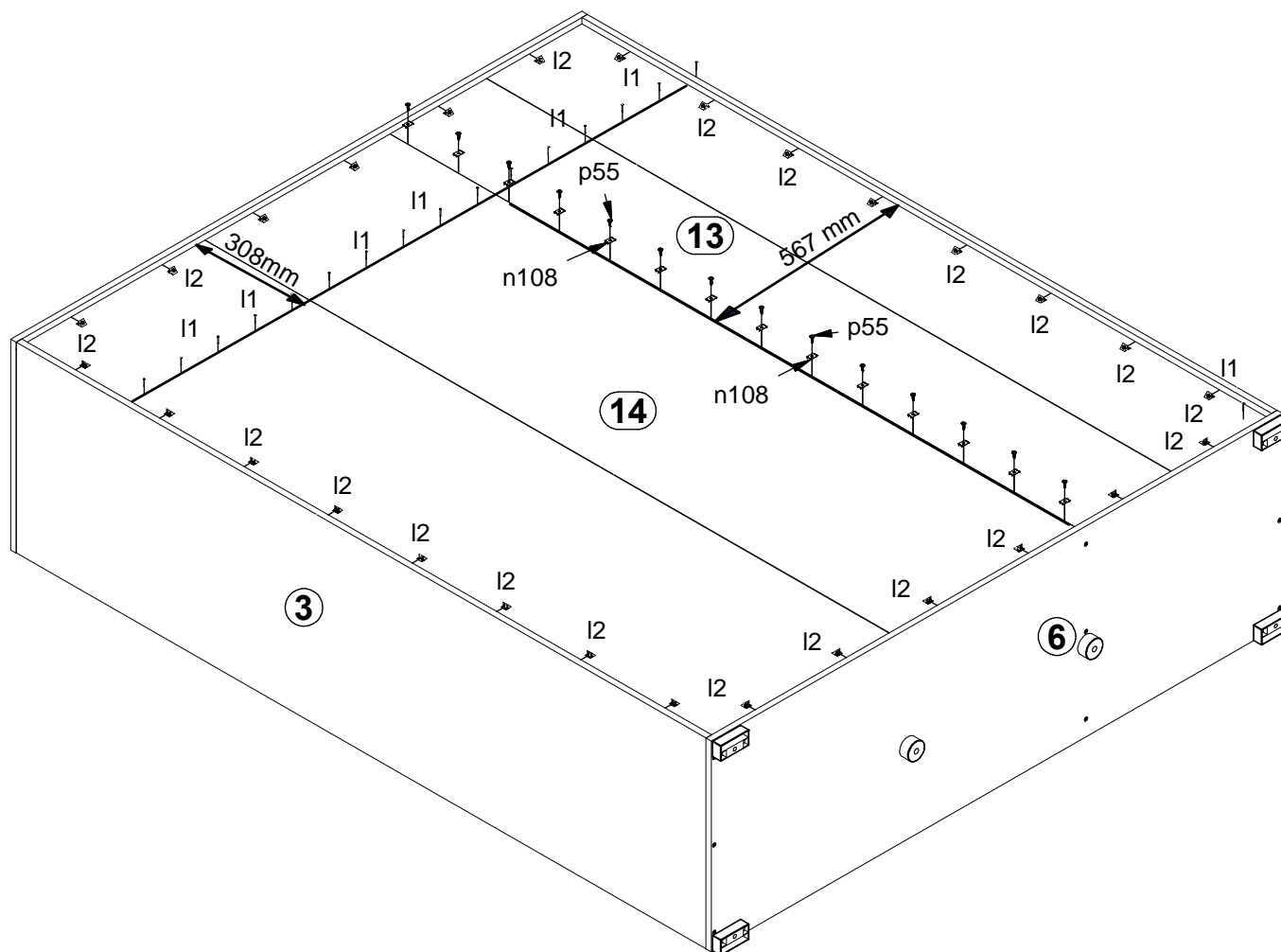
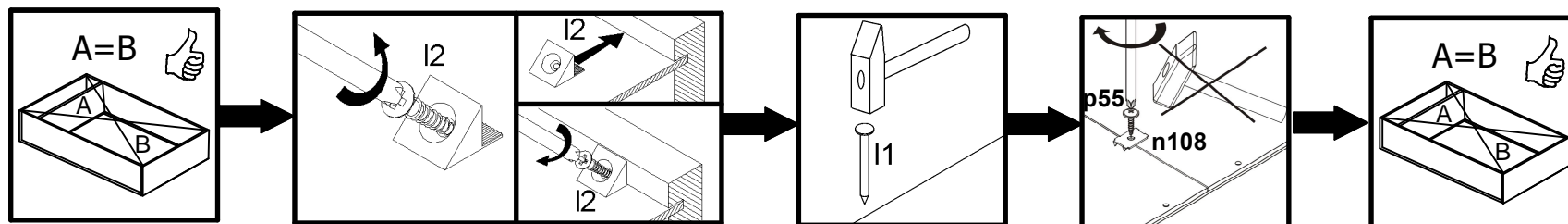

9

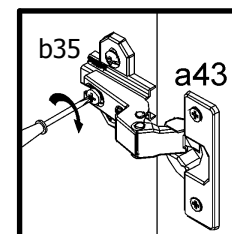
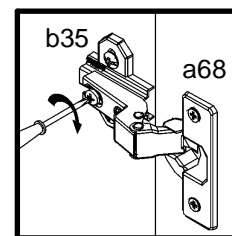
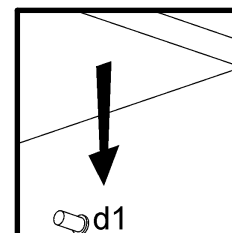
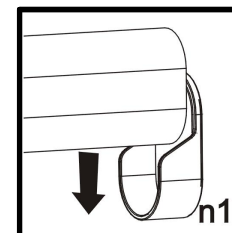
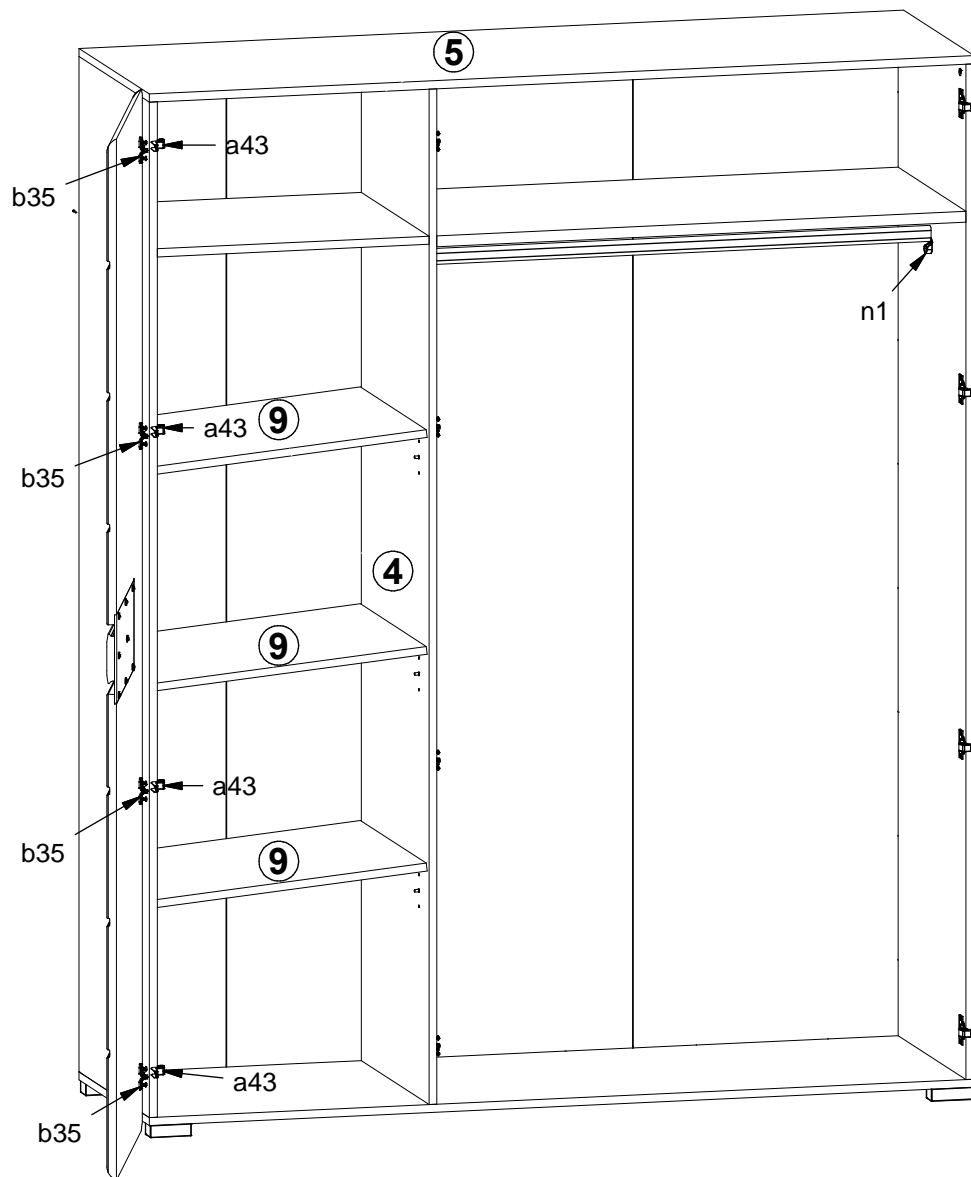

10

