

		§1	§11		
A	B	C (mm)		D	
1	S220-1027	1882	400	2/3	
2	S220-1028	1882	400	2/3	
3	S220-2019	571	400	1/3	
4	S220-2020	571	400	1/3	
5	S220-3011	537	370	2/3	
6	S220-3012	538	380	1/3	
7	S220-3013	531	360	1/3	
8	S220-5508	409	179	2/3	
9	S220-5509	691	410	2/3	
10	S220-7021	1934	600	3/3	
11	S220-7022	100	280	3/3	
12	S220-9305	1892	549	2/3	

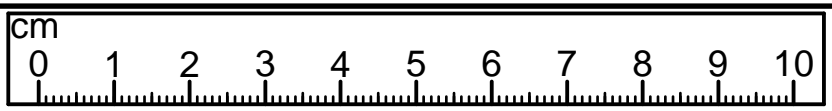

3x a108 55°: cizły domyki	3x b51 D1,5	8x d1 Ø5x17 mm	4x d33	4x e1 Ø7x50 mm	16x f1 Ø8x30 mm	4x k77 84x40/25 mm	10x l1	20x l2	10x l3	8x o54 Ø5,3/Ø8,3x4,8 mm	1x o93 5-8 mm	1x o931
8x p36 Ø4x25 mm	8x p38 Ø3,5x16 mm	6x p51 Ø3,5x15 mm	10x p61 Ø3,5x16 mm	12x r1 Ø15x12 mm #16	12x r42	12x s2 Ø16	6x s4 Ø5	3x s71 Ø35x62x40x10	1x z1			
										1x p38 Ø3,5x16 mm	1x n2611	

1

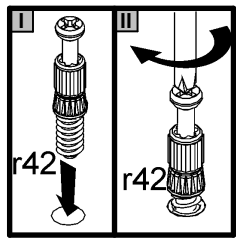
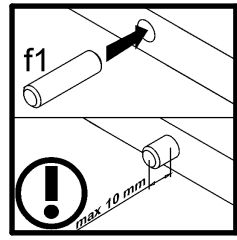
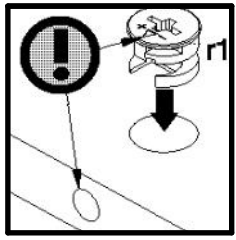
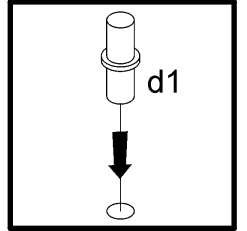
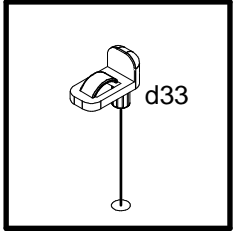
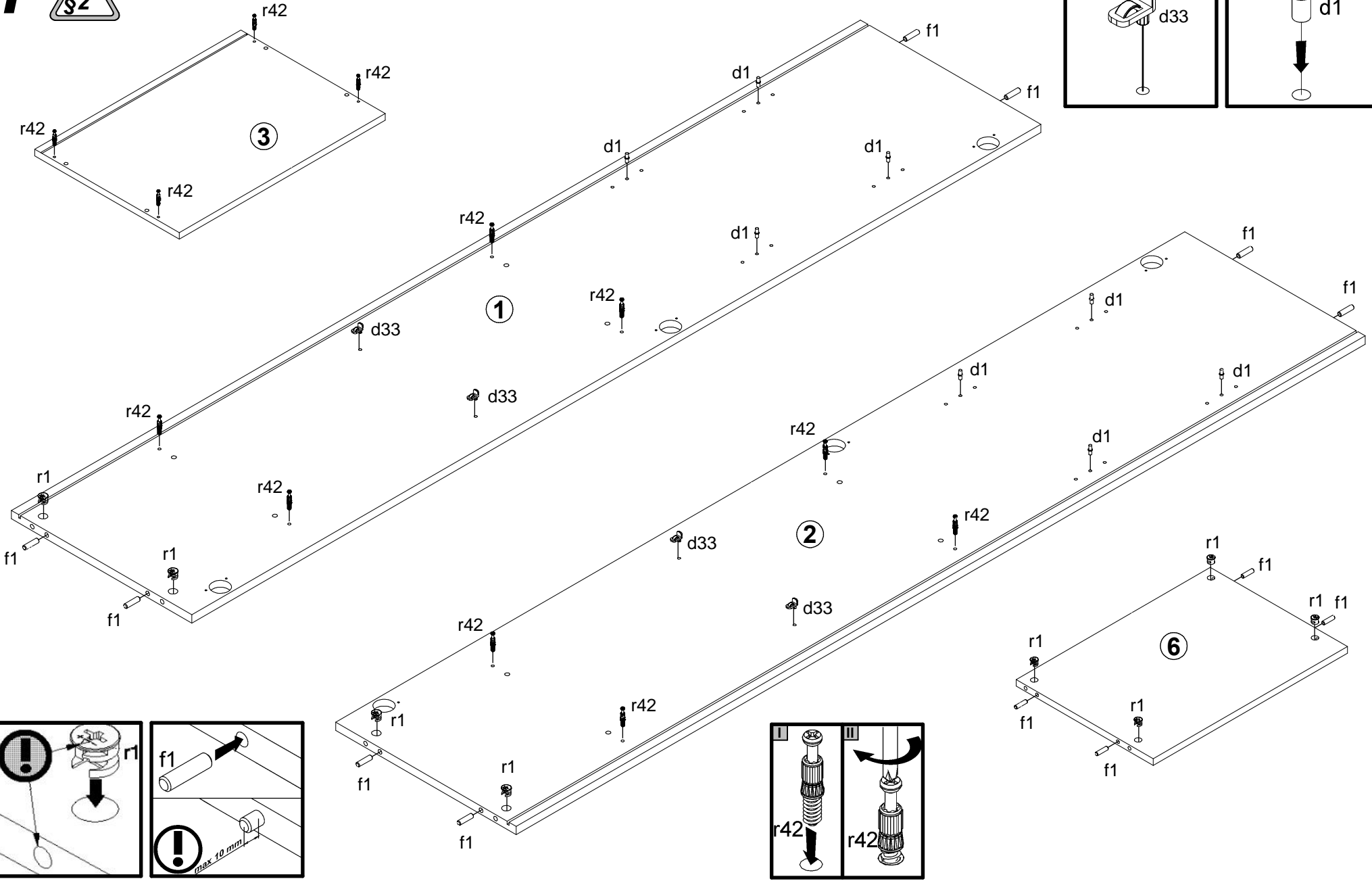

1

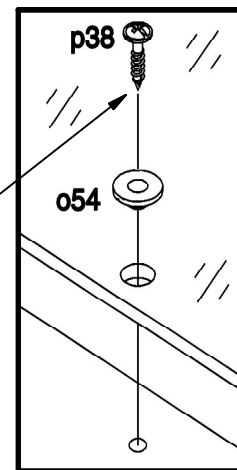
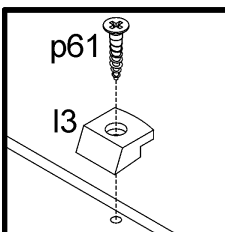
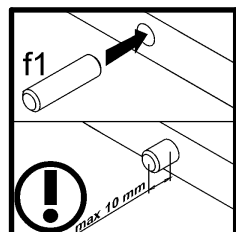
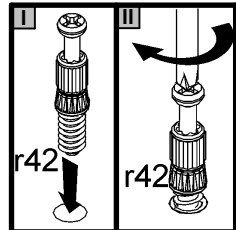
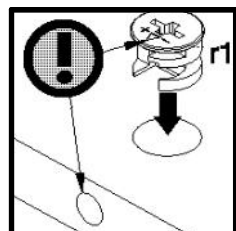
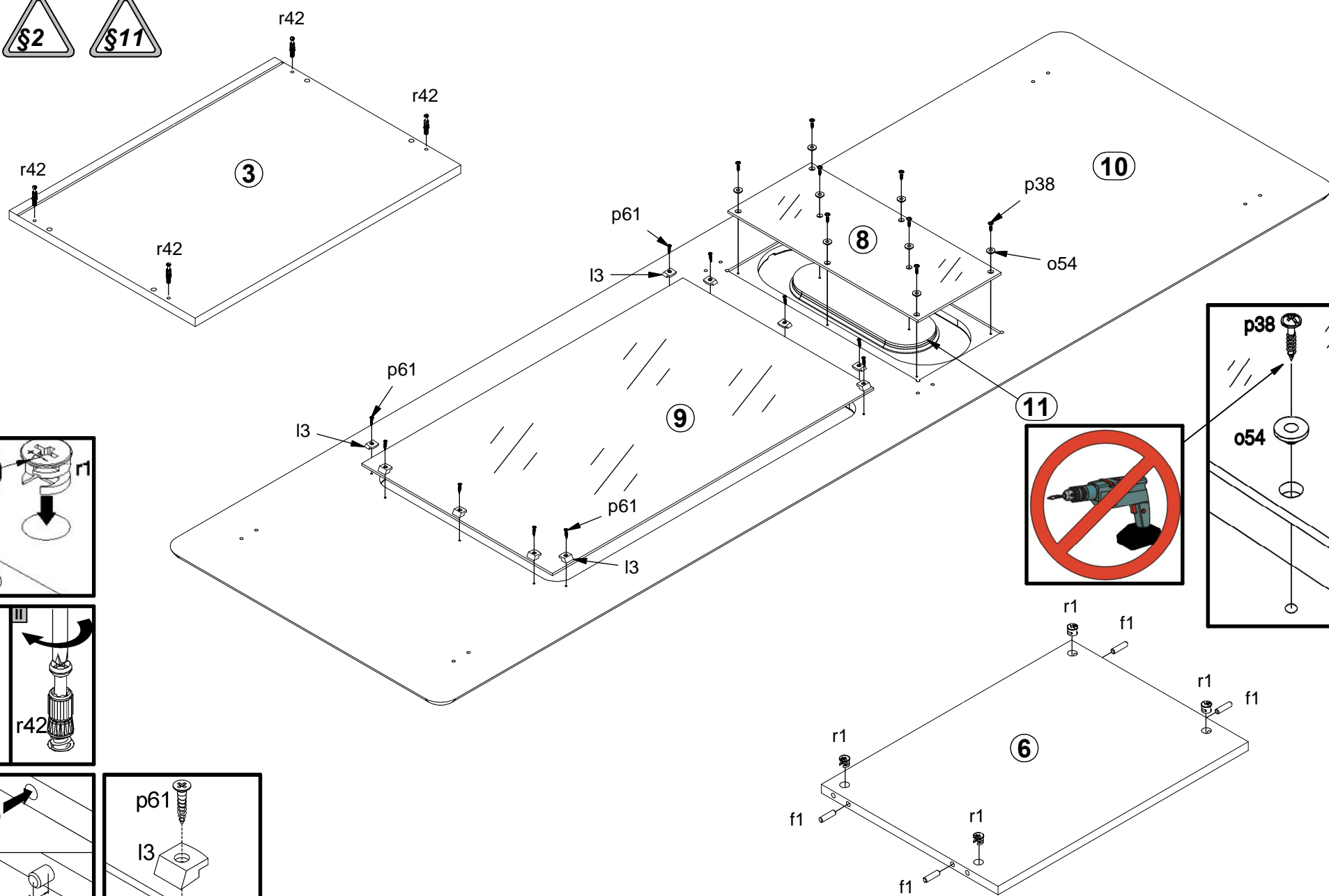

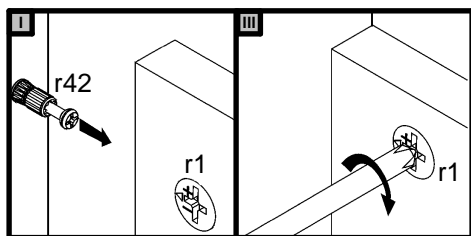

3

2

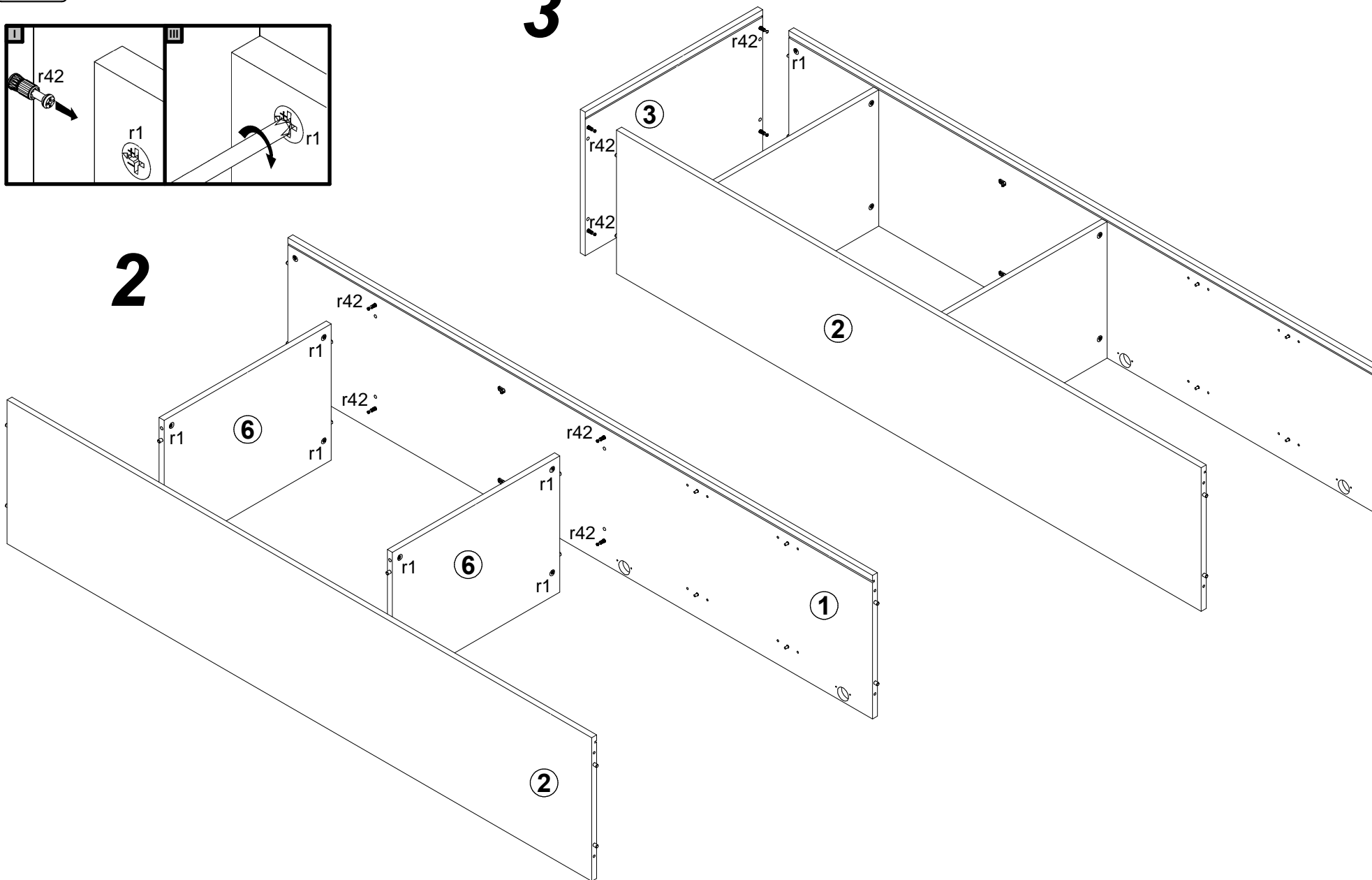

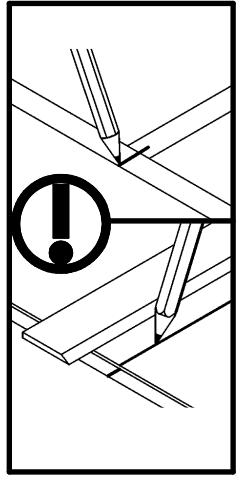
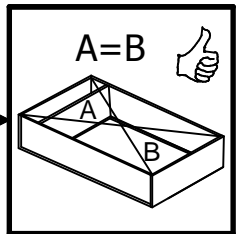
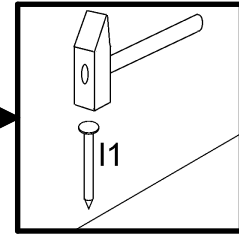
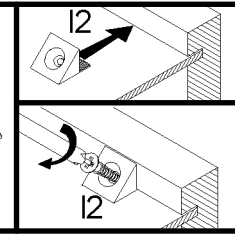
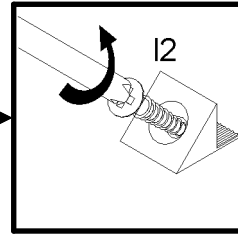
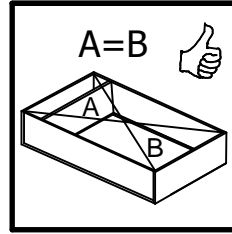

4



5

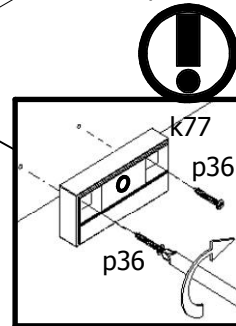
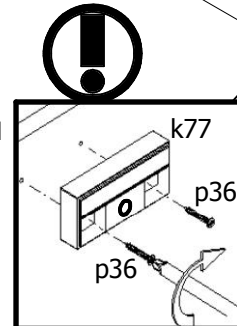
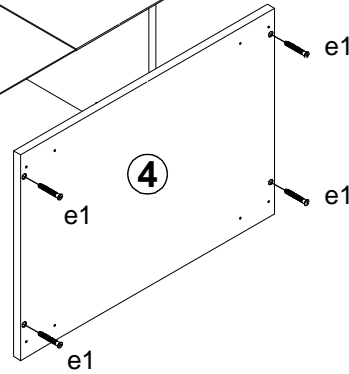
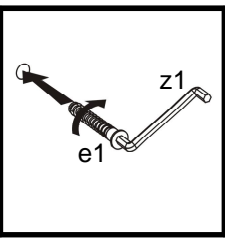
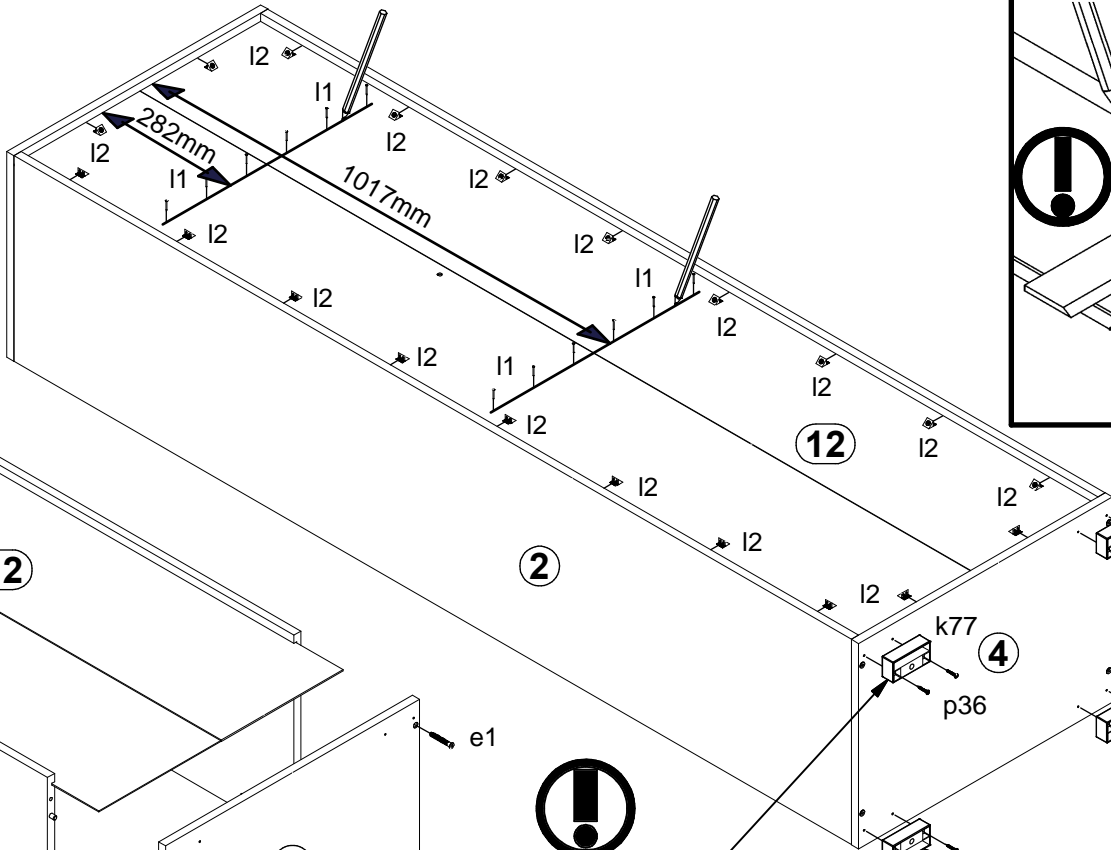

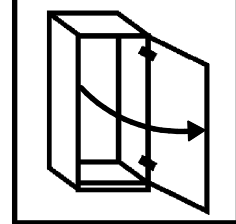
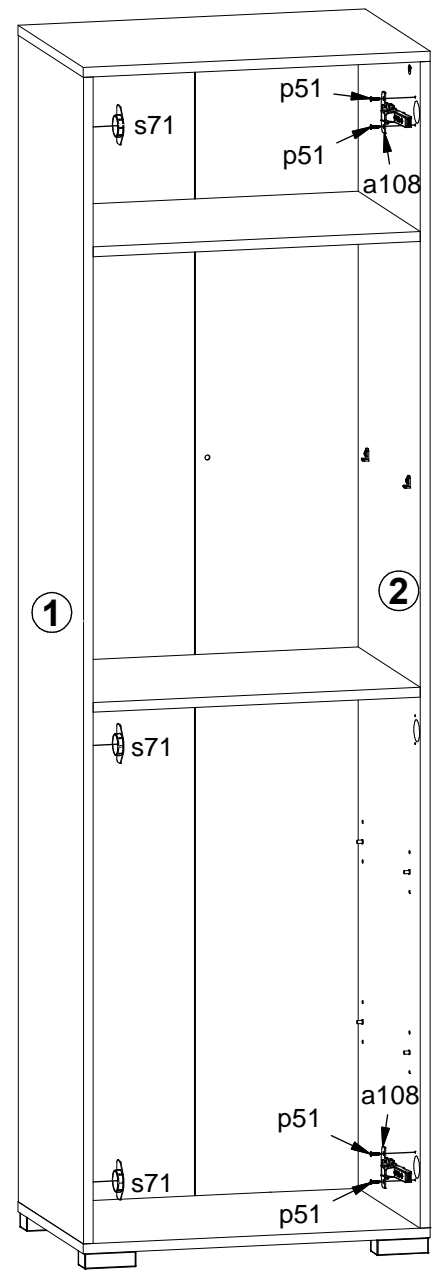
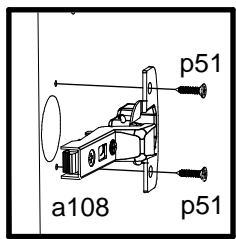
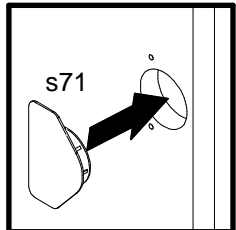
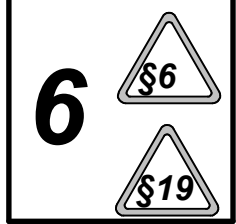
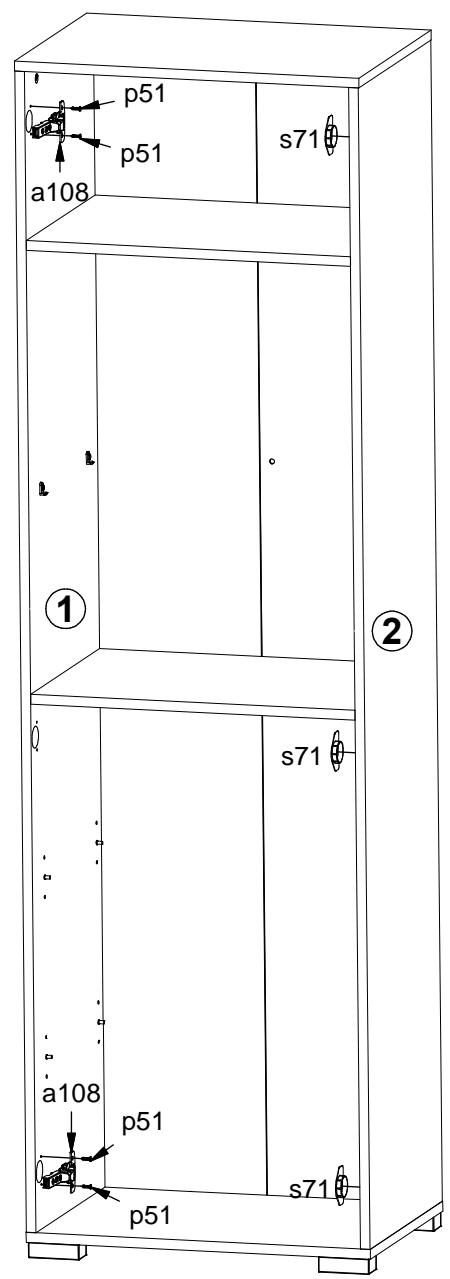
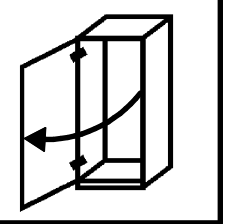

A

S220-REG1W/20/6

8 / 11

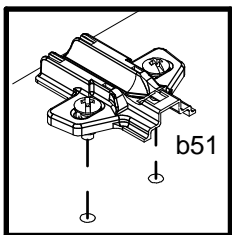
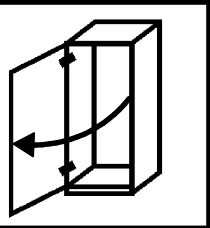

7

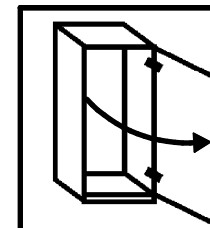
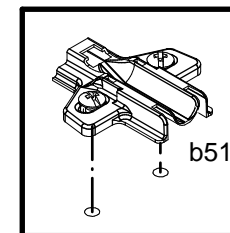
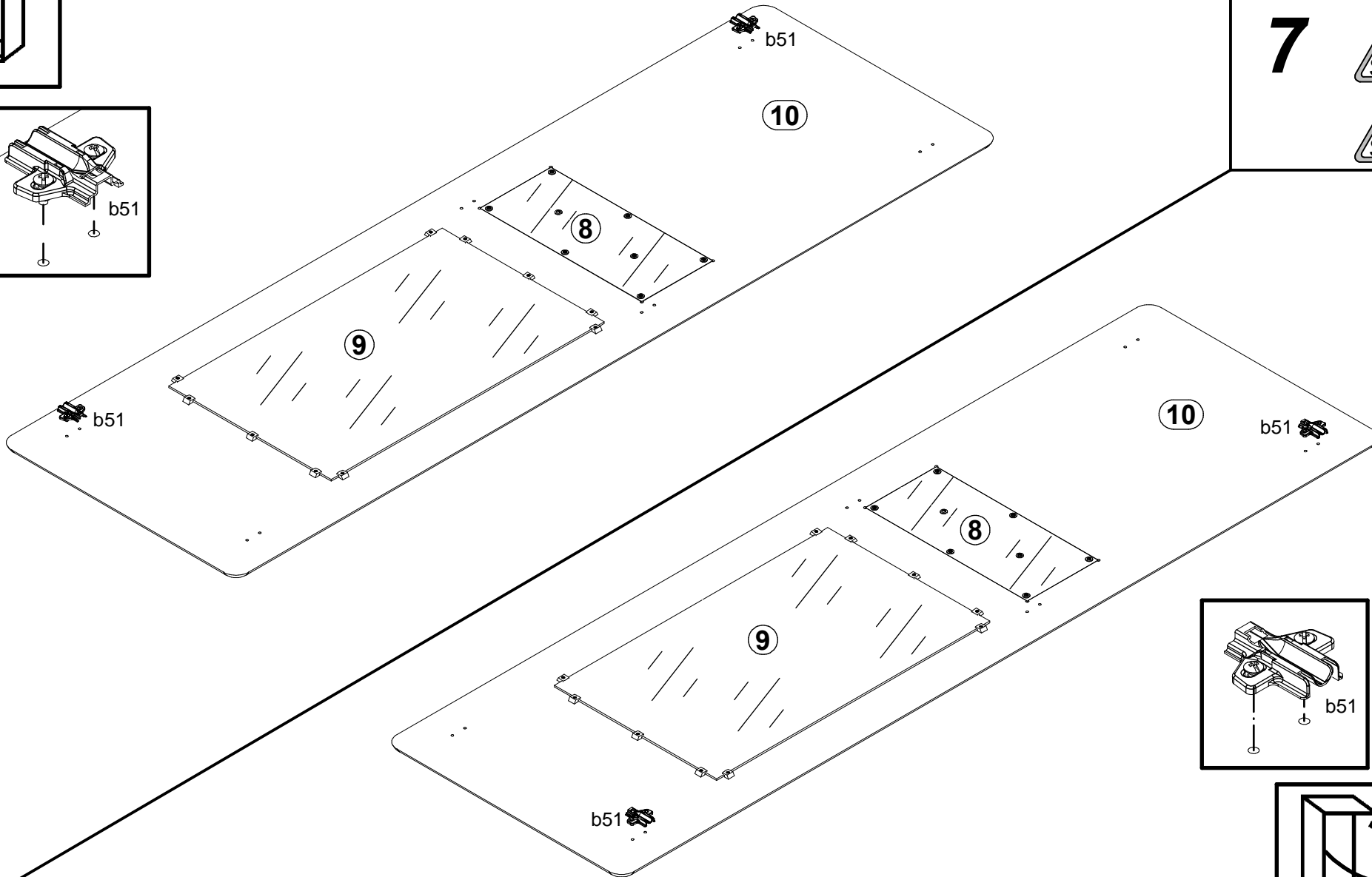

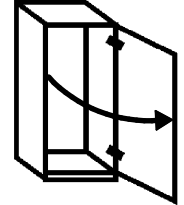
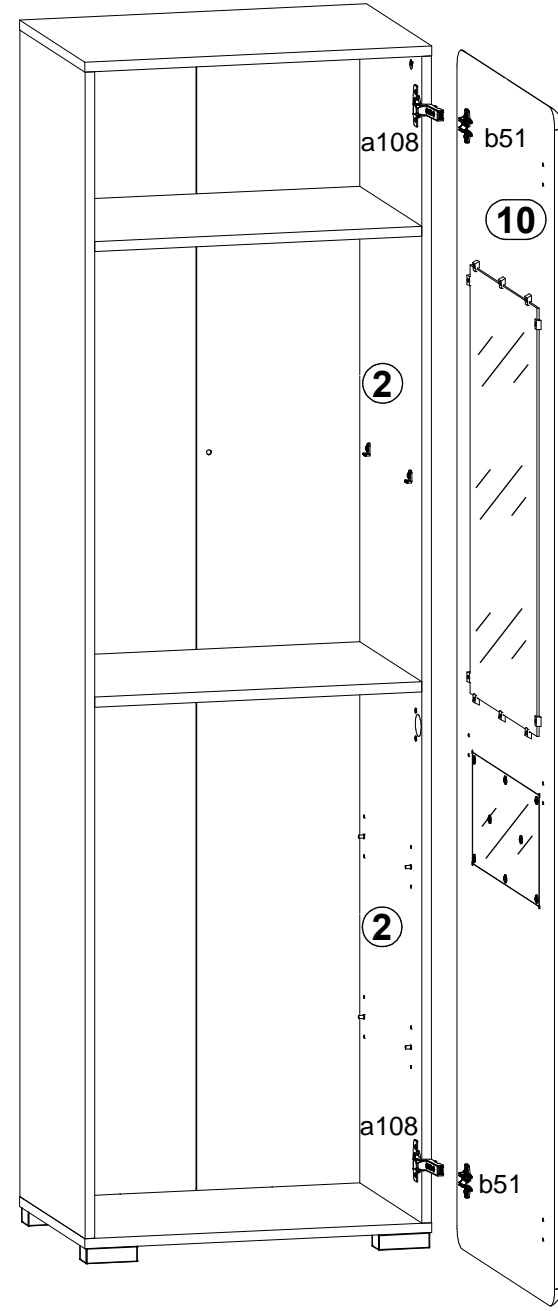
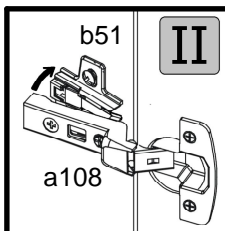
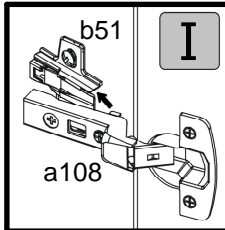
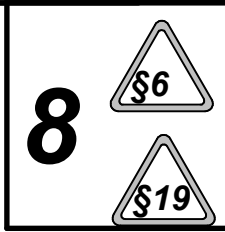
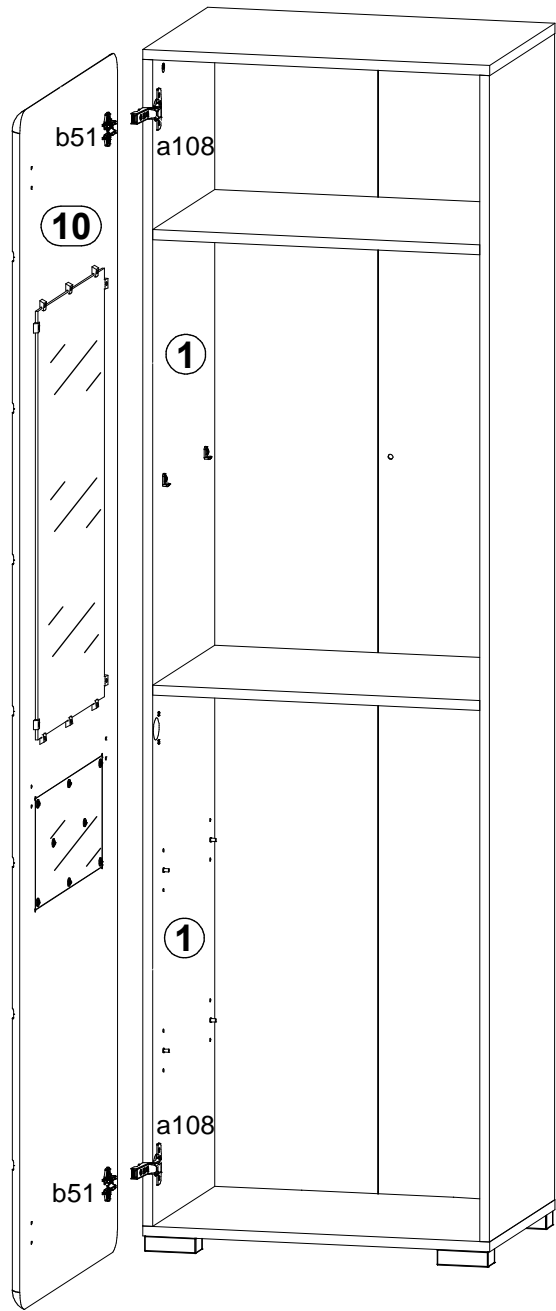
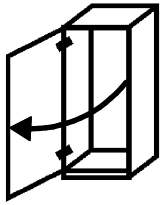

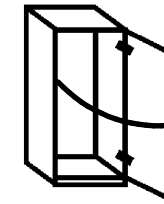
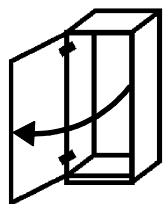

9

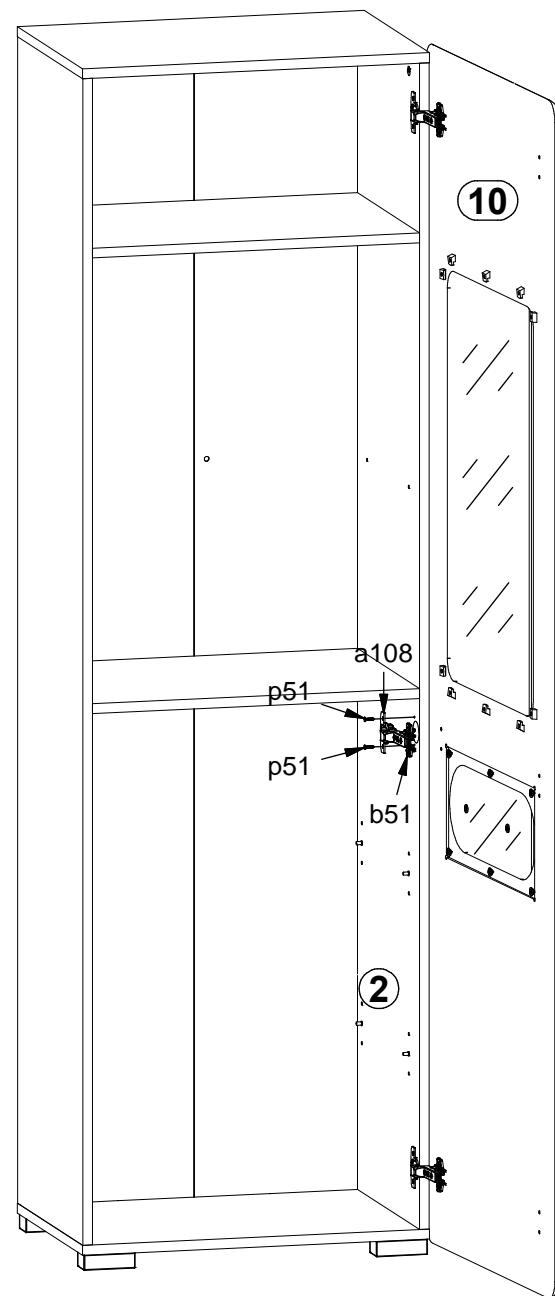
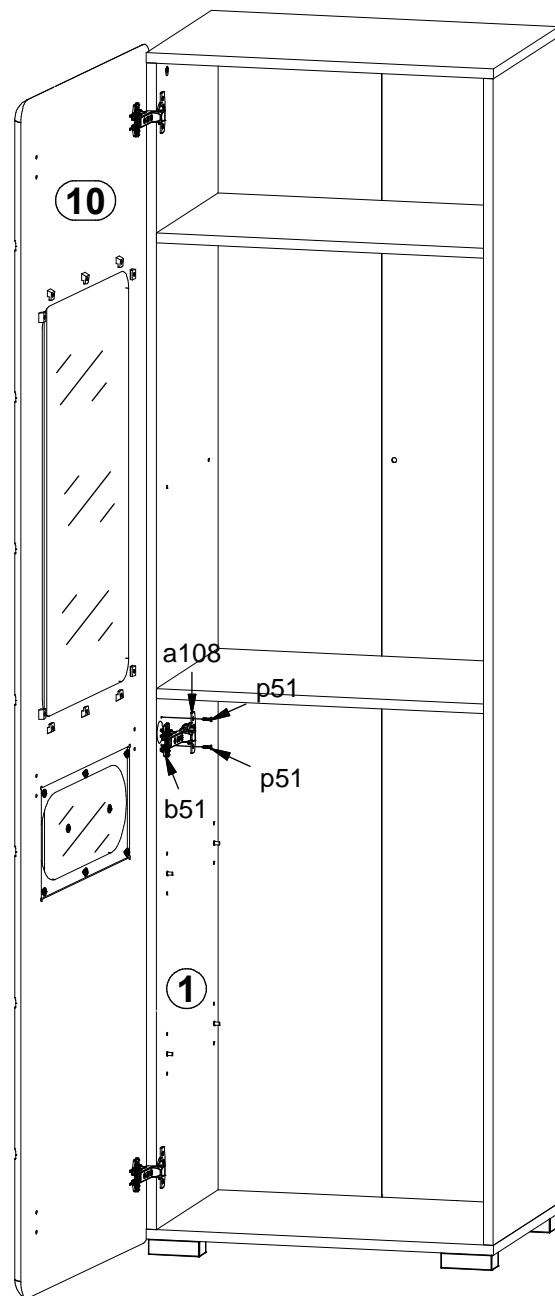
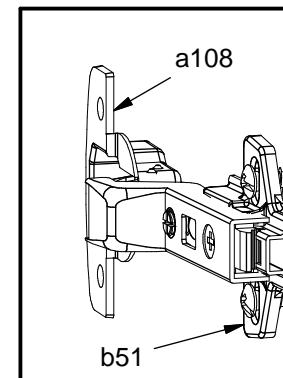
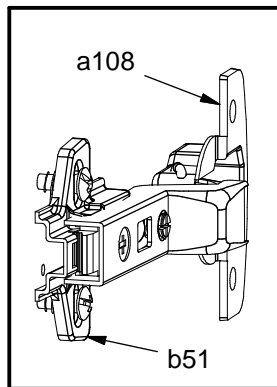
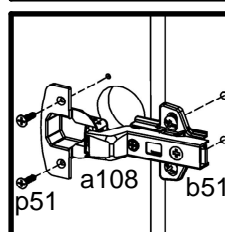
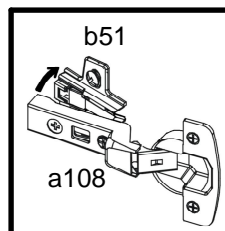
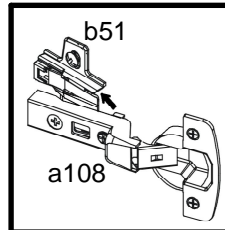

1

2

10

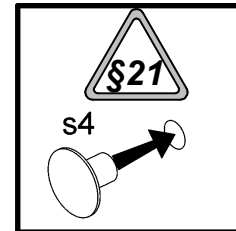
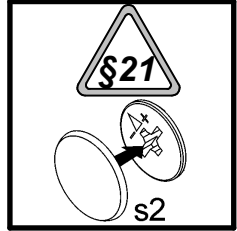
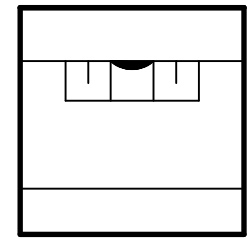
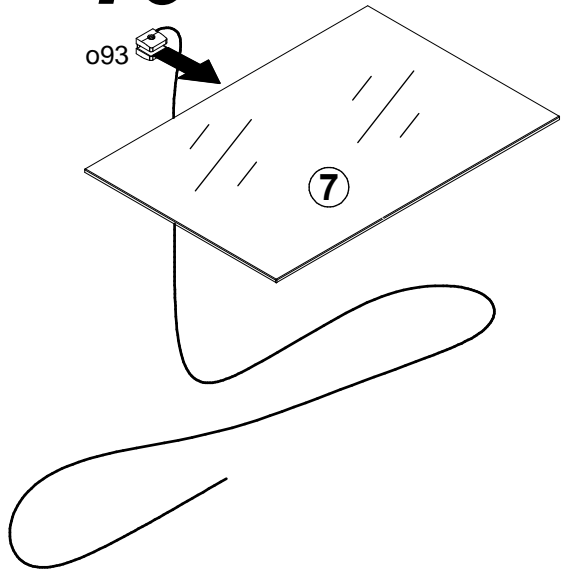

11

