

ATRISS

S137-KOM1D5S

A	B	C		D	A	B	C		D
1	S137-001	686	287	1/1	8	S137-317	277	285	1/1
2	S137-009	287	134	1/1	9	S137-501	250	100	1/1
3	S137-101	694	285	1/1	10	S137-502	250	100	1/1
4	S137-103	694	285	1/1	11	S137-506	226	100	1/1
5	S137-135	694	285	1/1	12	S137-904	719	583	1/1
6	S137-219	590	305	1/1	13	S137-914	248	254,5	1/1
7	S137-220	590	305	1/1					

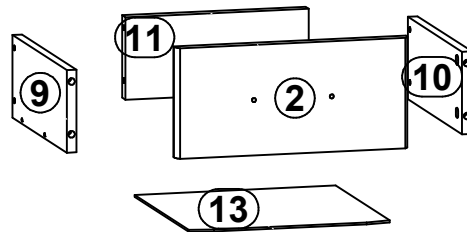
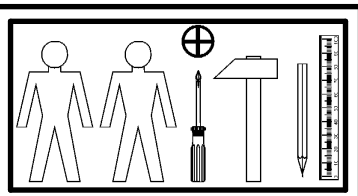
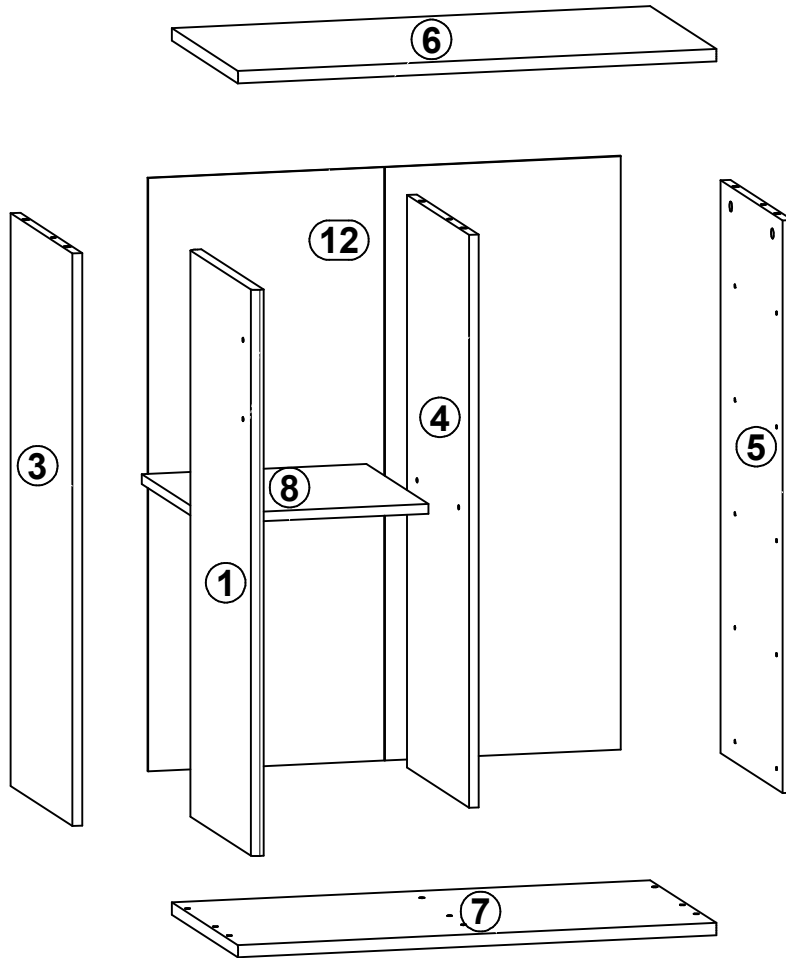
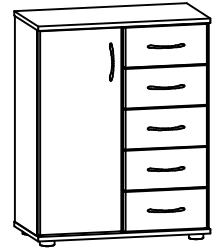

2x K8 a54	2x b1	6x c314	4x $\phi 5 \times 17$ mm d1	40x $\phi 5 \times 9$ mm e19	6x $\phi 5 \times 50$ mm e32	20x $\phi 6,5 \times 40$ mm f25	6x $\phi 6 \times 30$ mm f9	4x k27
40x l1	20x $\phi 3,5 \times 16$ mm p38	12x $\phi 4 \times 25$ mm p87	26x $\phi 12 \times 10,5$ mm #12 r15	26x r16	5x 250 mm w17CL	5x 250 mm w17CR	5x 250 mm w17DL	5x 250 mm w17DR
1x n26l1	1x $\phi 3,5 \times 16$ mm p38							

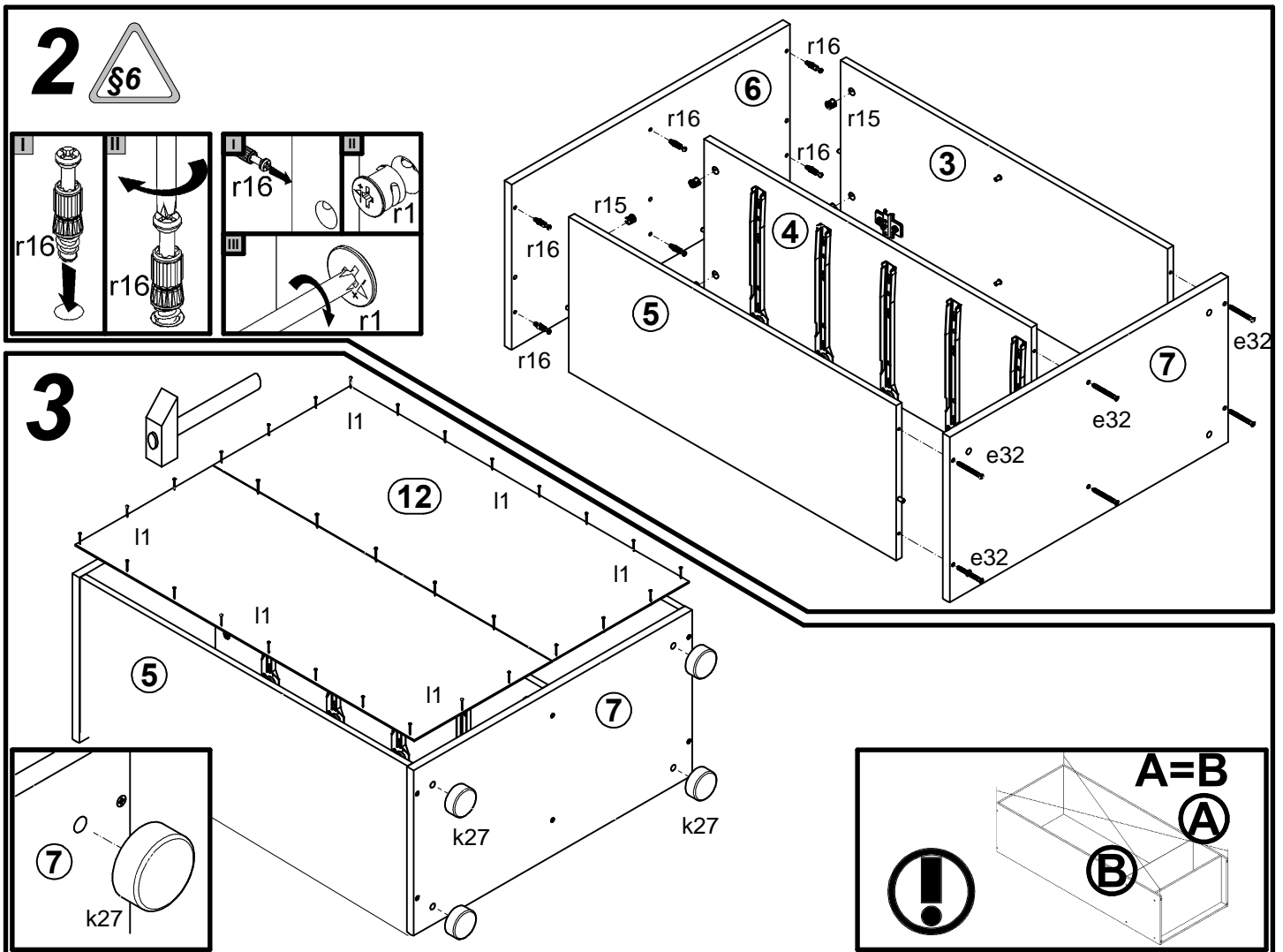
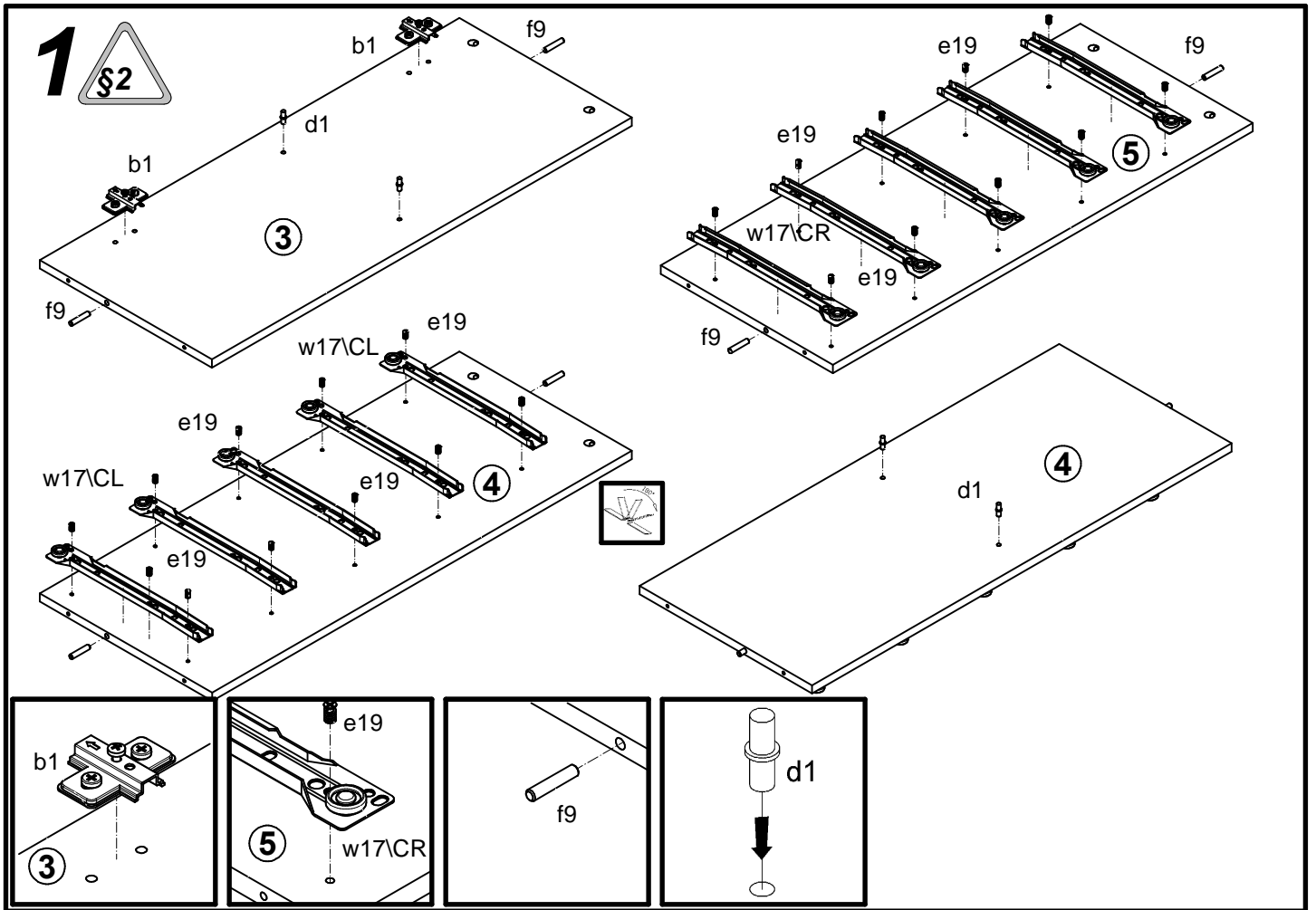

4

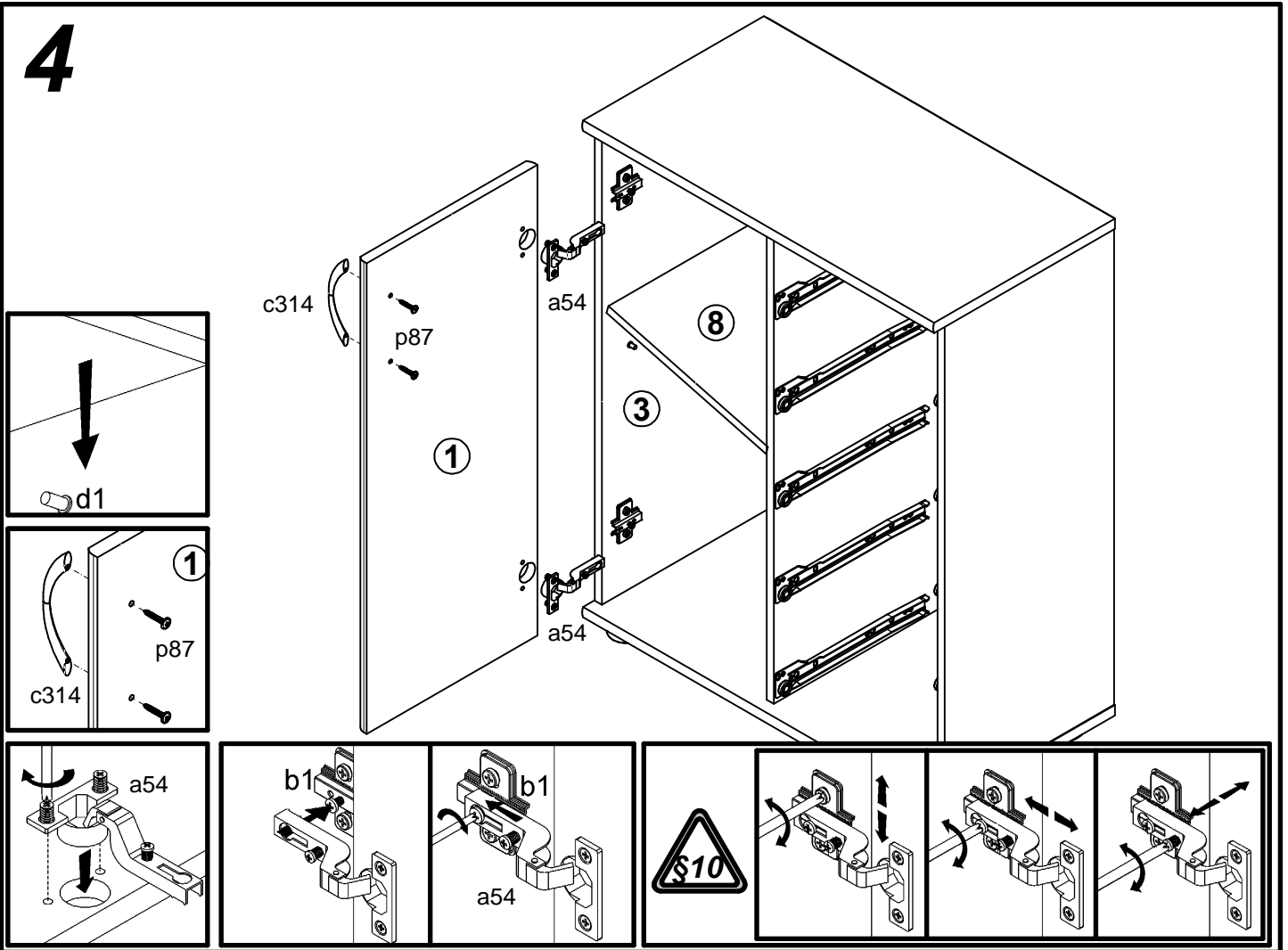

5

