

# ALEVEL

# S113-SZF3D

A	B	C	D	A	B	C	D		
1	S113-006	1821	496	4/5	10	S113-311	466	556	2/5
2	S113-018	1923	496	5/5	11	S113-315	1502	536	2/5
3	S113-107	2005	540	1/5	12	S113-503	1500	50	2/5
4	S113-108	2005	540	1/5	13	S113-576	2007	75	3/5
5	S113-109	1827	556	1/5	14	S113-577	2007	75	3/5
6	S113-110	1827	556	1/5	15	S113-912	1854	520	1/5
7	S113-306	1502	536	2/5	16	S113-923	1854	482	1/5
8	S113-307	502	536	2/5	17	dr-497	497	22	2/5
9	S113-310	466	556	2/5					

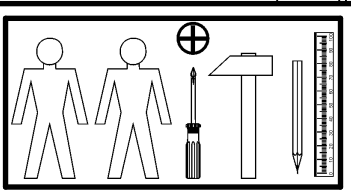
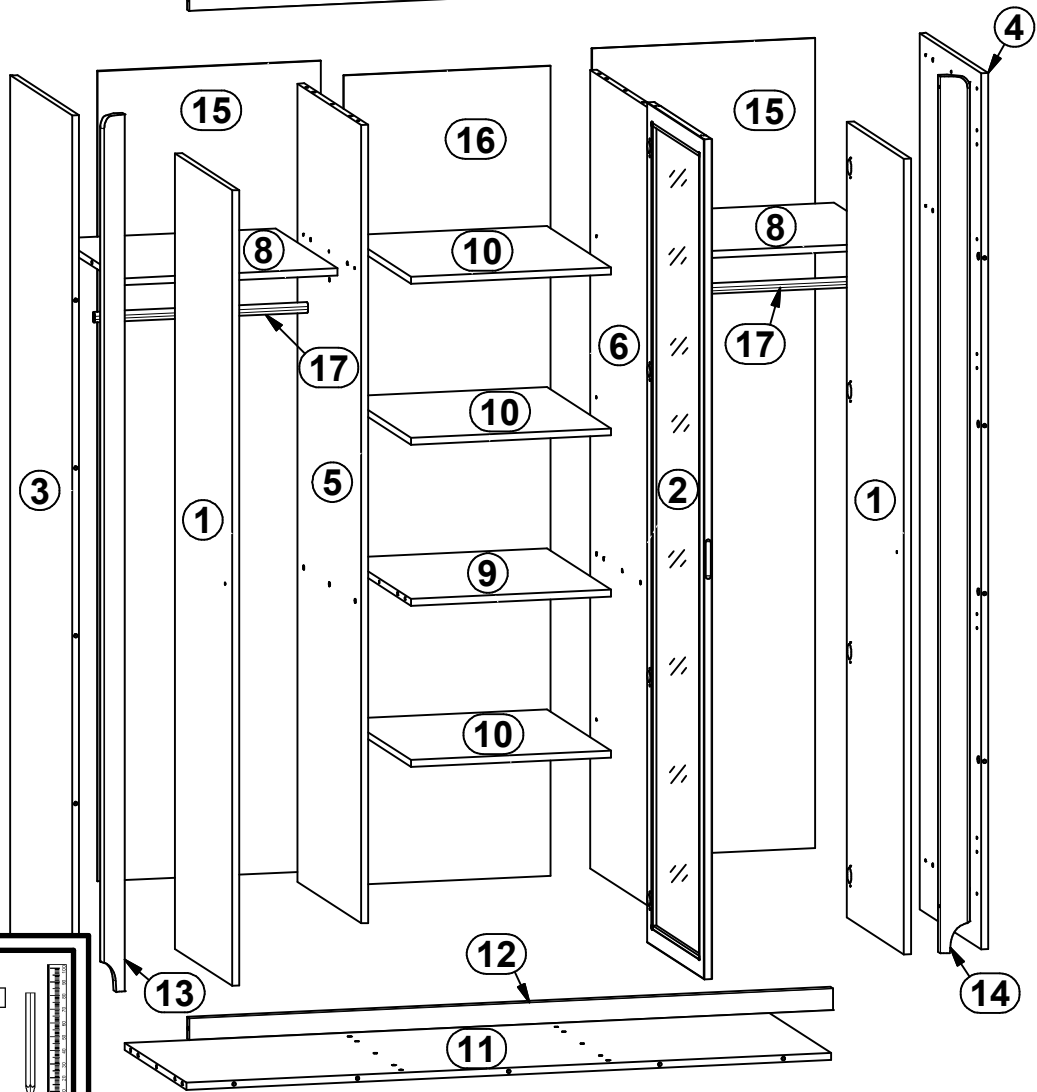
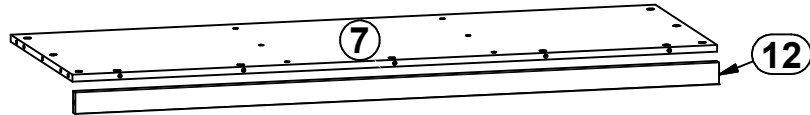
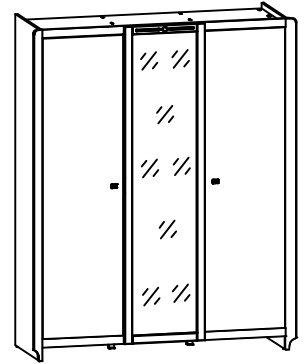

4x  a2	8x  a3	4x  b1	8x  b19	2x  c305/1	12x  d1 φ5x17 mm	20x  e1 φ7x50 mm	18x  e2 φ6,3x13 mm	28x  f1 φ8x30 mm
2x  j30 M4x22 mm	4x  k1	2x  k38/3	2x  k38/7	155x  l1	4x  n1	4x  p1 φ3,5x13 mm	8x  p38 φ3,5x16 mm	16x  p51 φ3,5x15 mm
46x  r1 φ1,5x12mm #16	46x  r42	20x  s2 ø16	1x  z1	1x  n26/1	1x  p38 φ3,5x16 mm	6x  s1		

1 

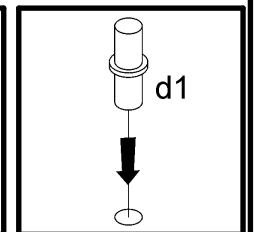
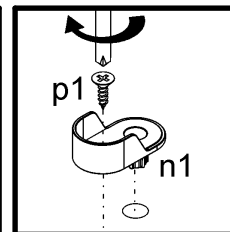
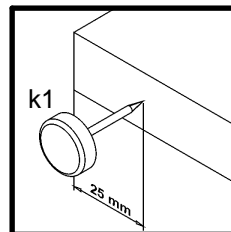
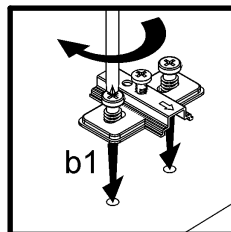
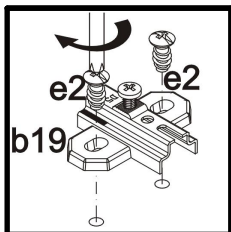
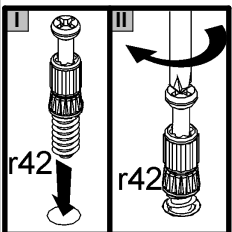
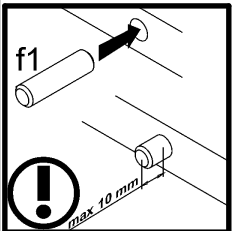
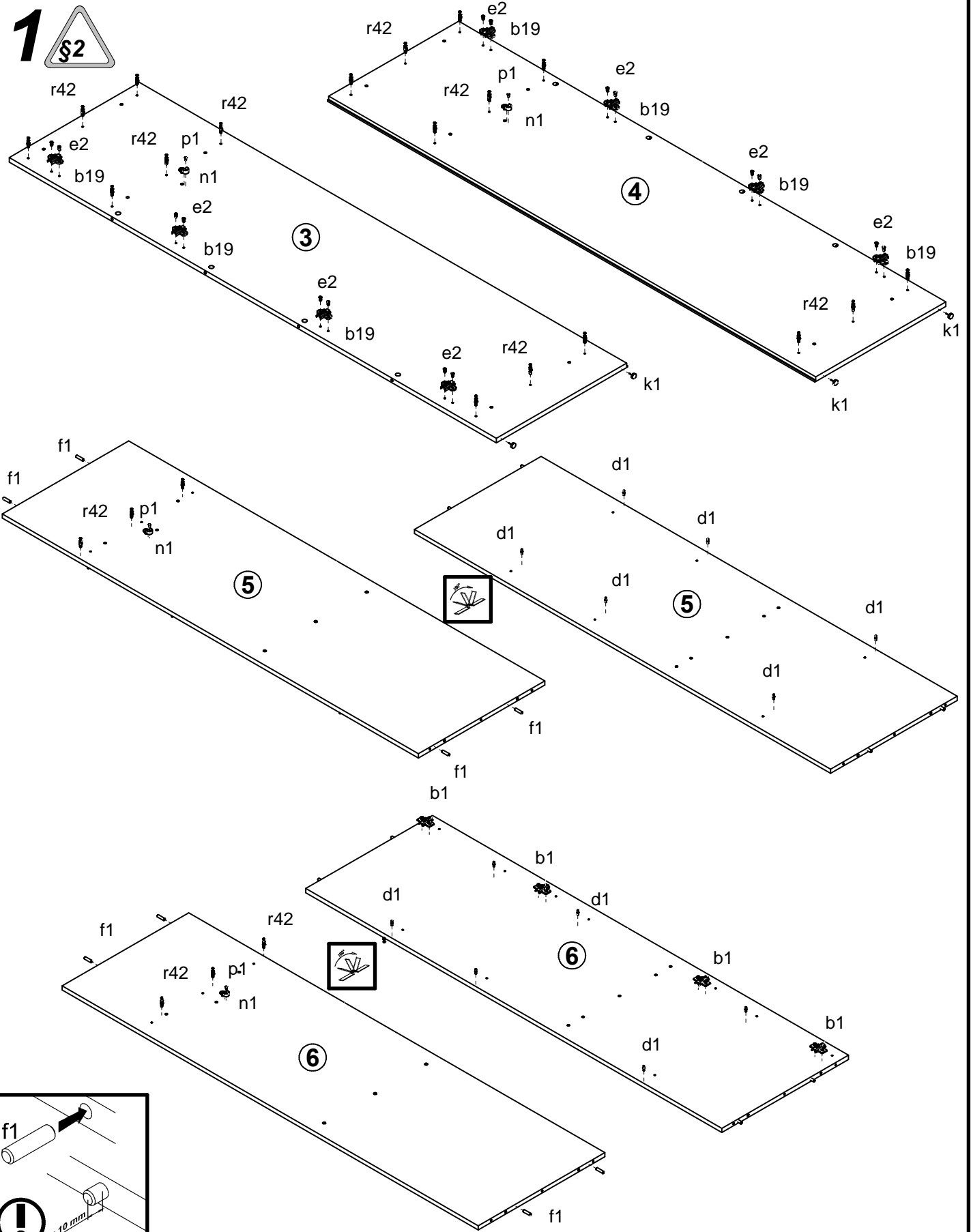

# 2



## I

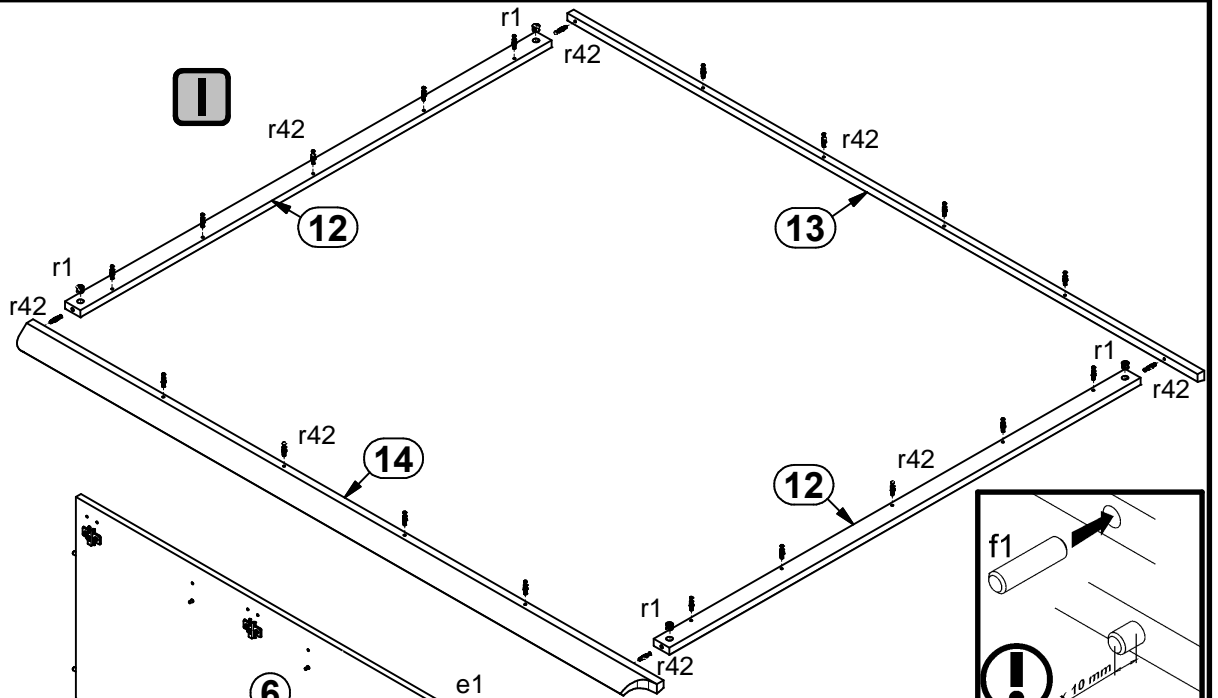

## II

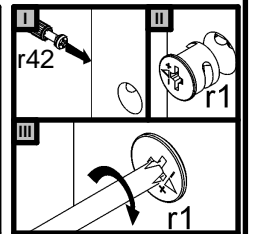
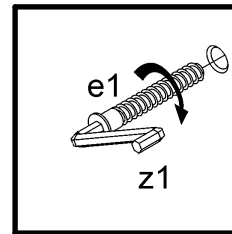
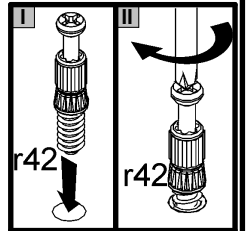
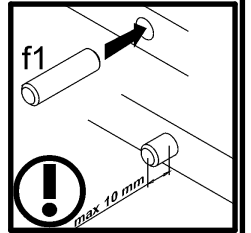
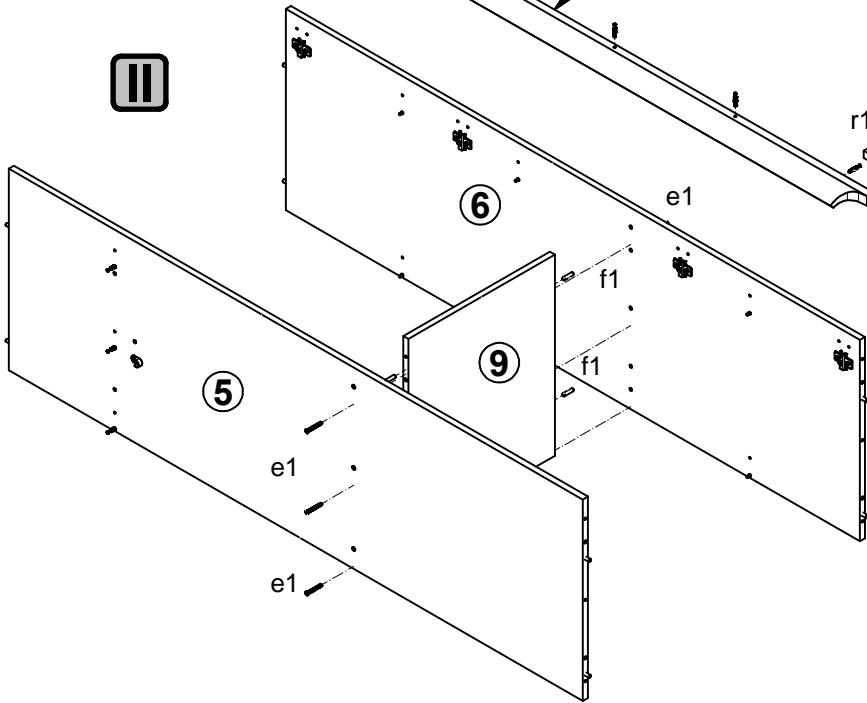

# 3

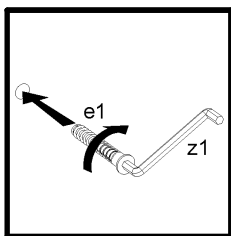
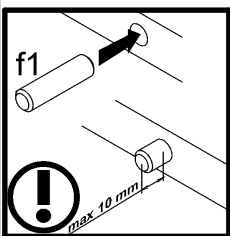
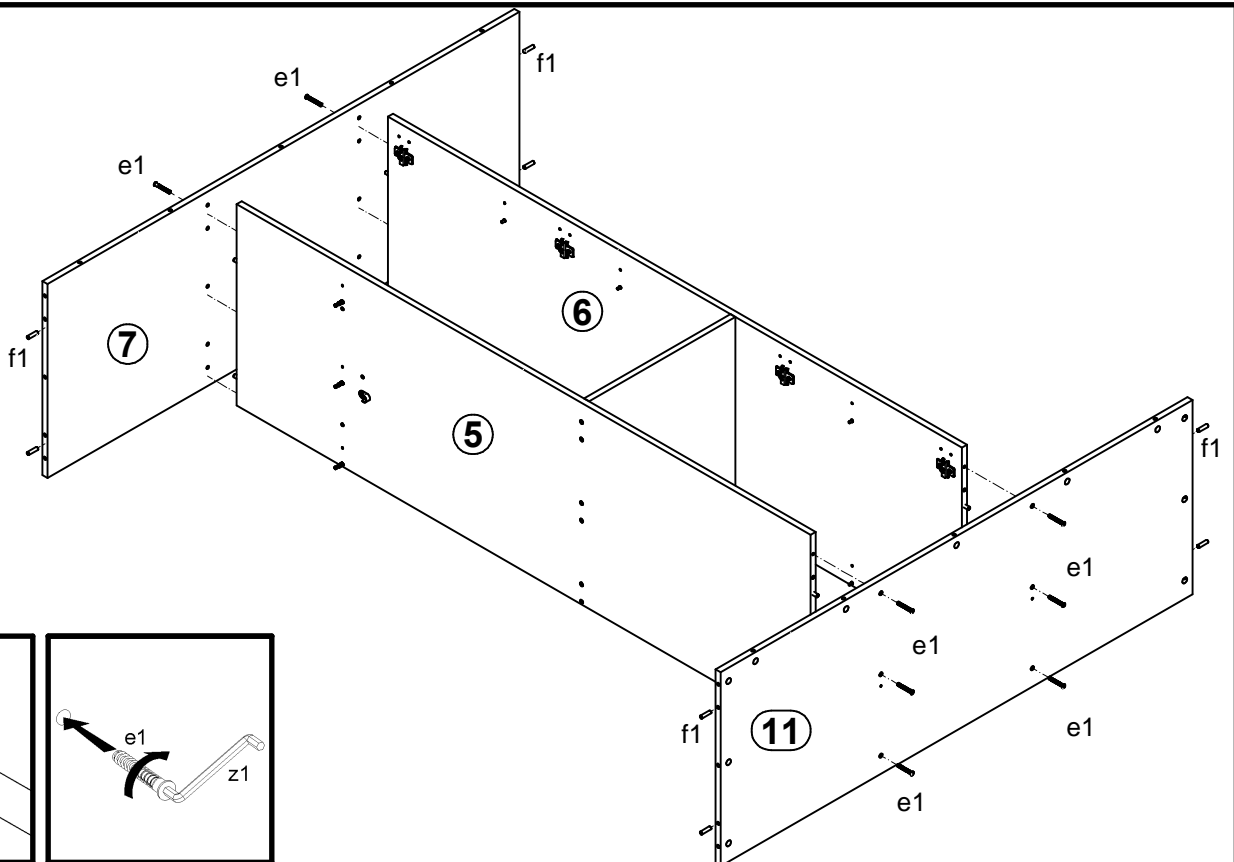

# 4

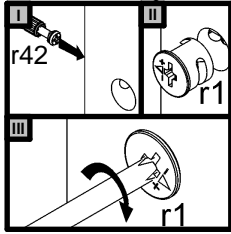
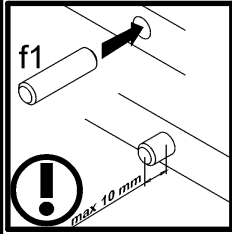
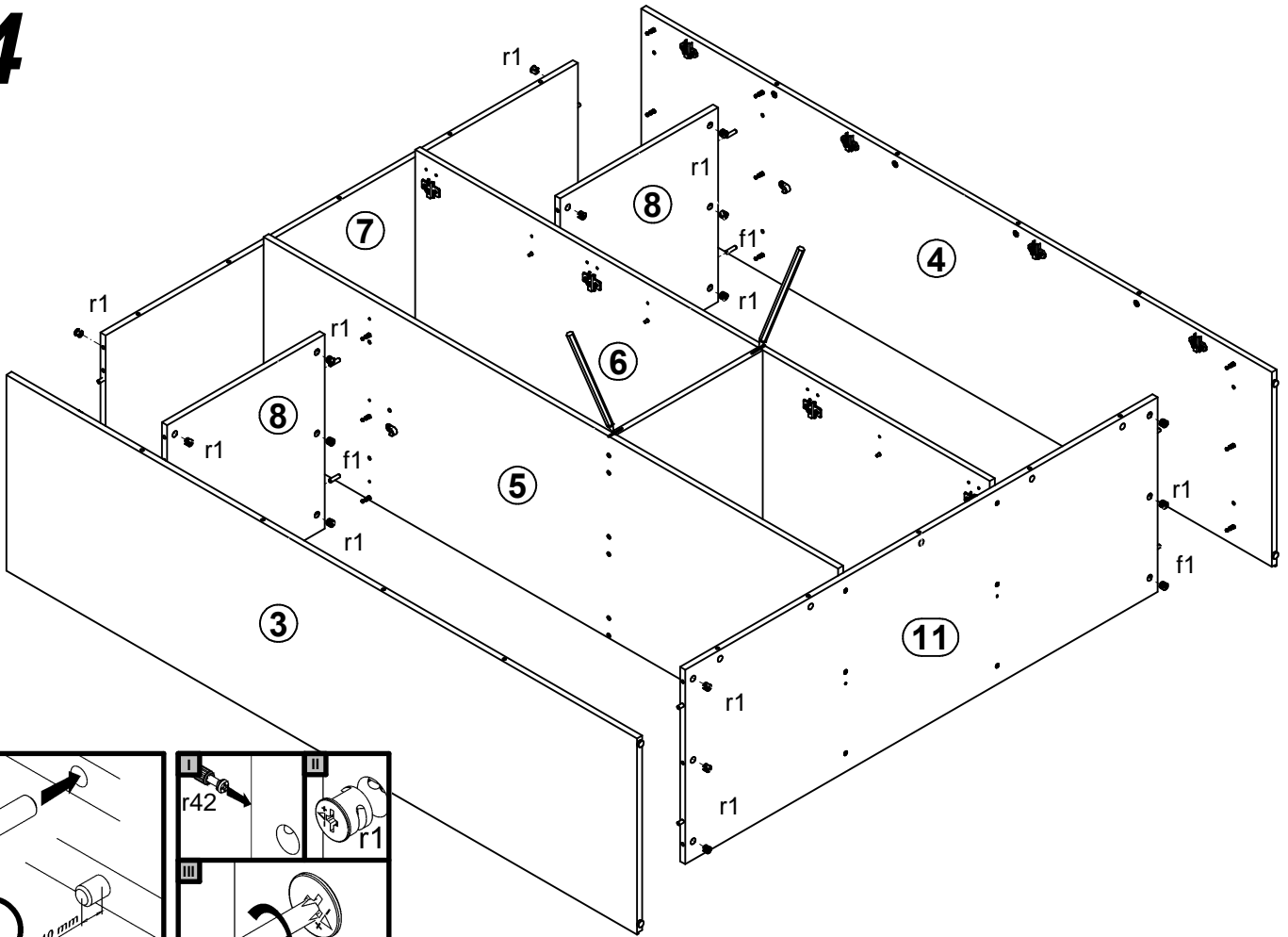

# 5

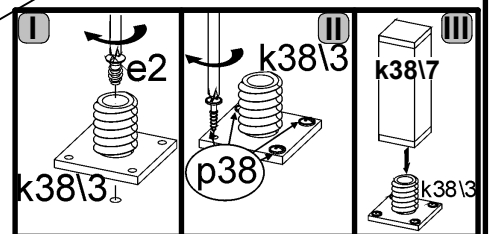
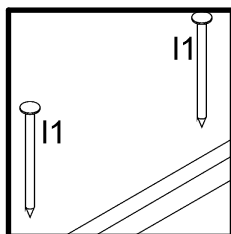
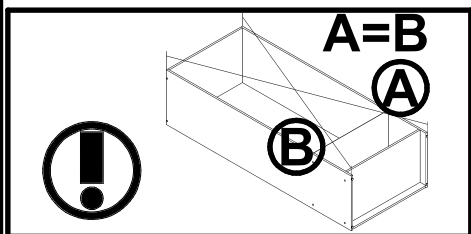
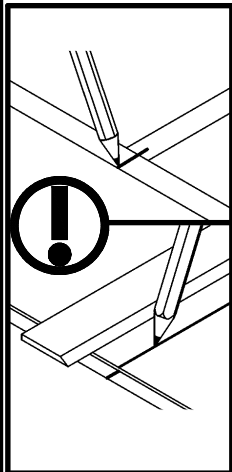
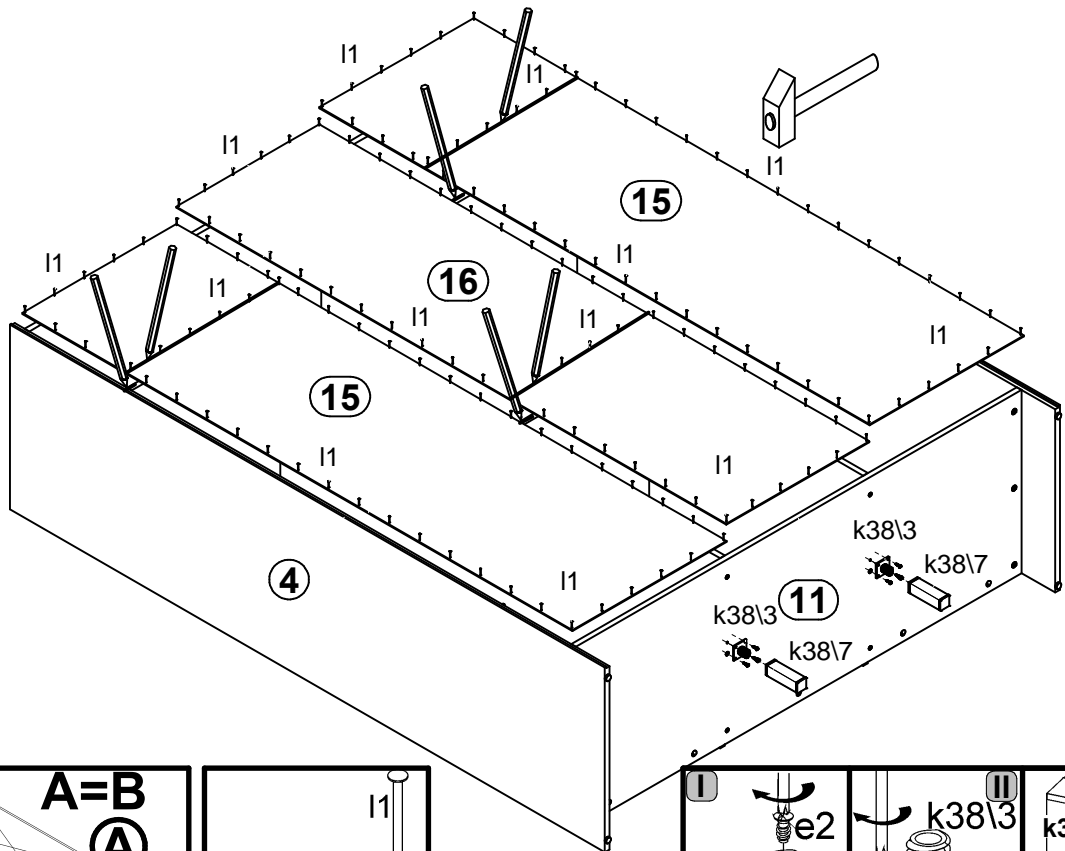

# 6

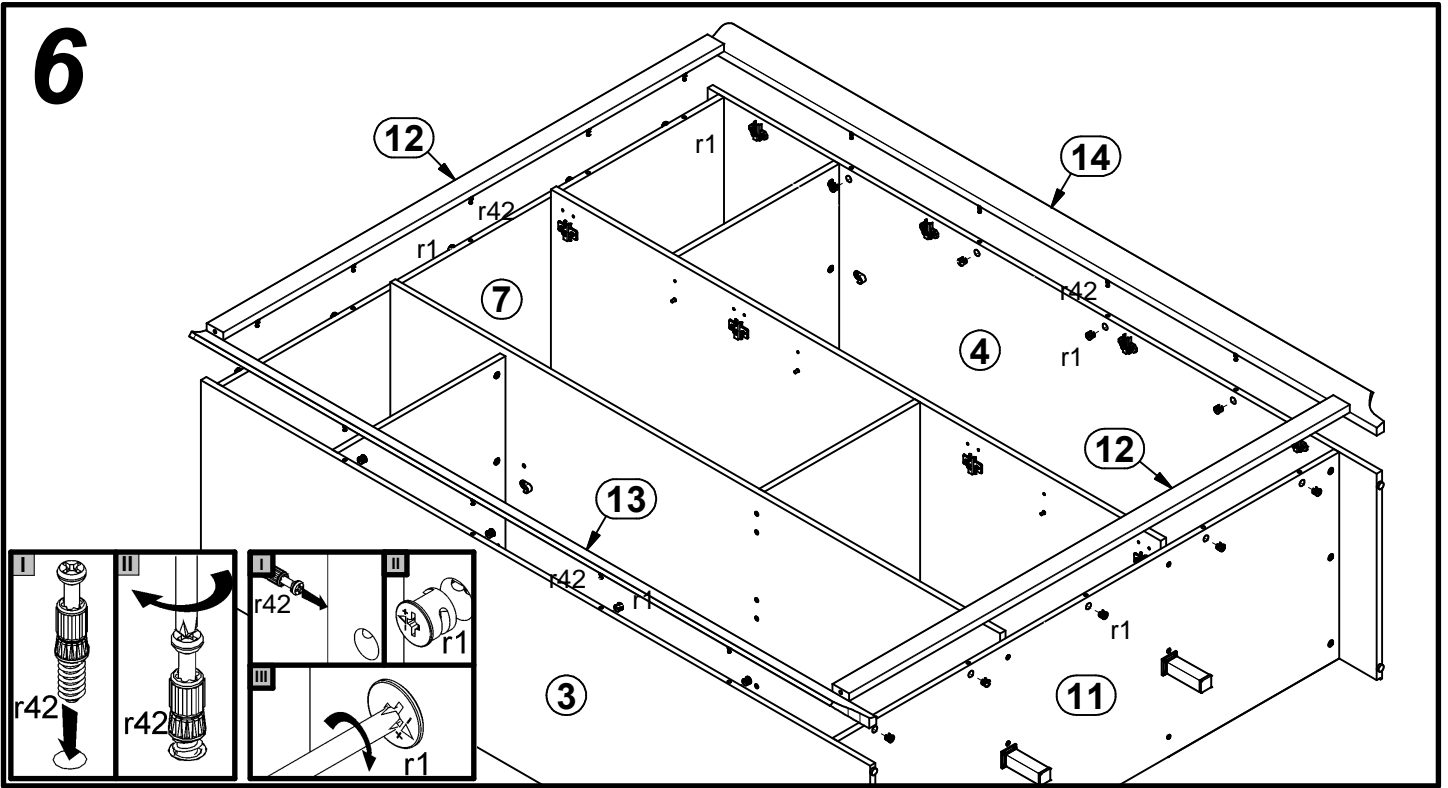

# 7

